



# Power Installation Instructions



langeoriginals.com  
Lange Originals  
3651 S. 700 E.  
Salt Lake City, UT  
801-262-7322



PLEASE READ ALL INSTRUCTION BEFORE INSTALLATION

**Parts List**

Parts are listed by part number, description, and quantity. The part number may be referenced in the instructions designated by parenthesis () for your convenience. Parts are updated periodically and may vary in color or shape.

**014-400 Hoist-A-Top Power Upgrade**

Part Number	Description	Qty
HAT-050	Zinc Plated 3.5" Screws	14
HAT-125	1.5" Wood Screws	9
HAC-043	Wire Rope Clamps	6
HAT-106	4" Lag Screw	2
HAC-023	3/8 Flat Washer	2
HDW-031	Thimbles	2

**Power Unit & Mounting Components**

HAT-021	Power Unit	1
HDW-053	U-Bracket for Power Unit	2
HDW-051	Bolts for U-Bracket	4
HDW-090	Washer for U-Bracket	4
HDW-052	Lock Washer for U-Bracket	4
HAT-006	Power Unit Mounting Bar	1
HAT-116	Single Flush Mount Pulley	2
HAT-138	Weighted Safety Stop	1

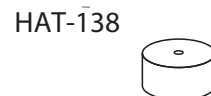
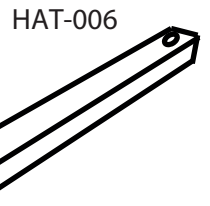
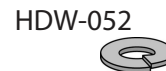
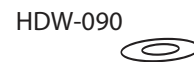
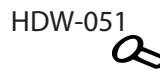
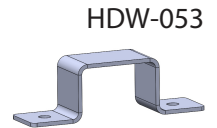
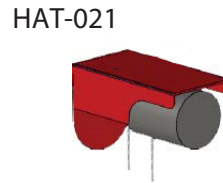
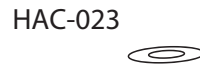
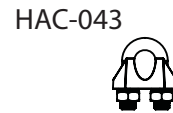
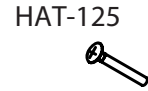
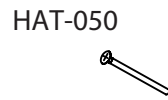



## Lange Power Unit Installation Instructions

**Tools Needed:** Safety glasses, gloves, screwdrivers, socket wrench set with driver and sockets, drill, standard drill bits, stud-finder, and chop saw/skill saw.

Specialized tools not required. Person should have a basic knowledge of common household tools.

Note that text underlined in the installation guide is found in a glossary of terms in the back of the guide.

### Lifting Cautions

All garages are different. Carefully watch the video and read the written instructions before installing. If you are unsure or uncomfortable with installing this product contact a structural professional. Always test this mechanism using a static and live load. Misuse or improper installation of this product can result in serious injury or death. Follow all safety rules and regulations of tools and ladder. Wear safety glasses, gloves, and boots while installing this product. Never walk under or allow others to either play, stand, or work under the lifted top. Keep your body, especially your hands away from edges of the top. We recommend you push or pull the top from the side and not use the bottom edge. Periodically check the Hoist-a-Top® system for tightness, damage, or bent parts. Never lift your top tight against the ceiling. This puts undue stress on the top and the hoist. Lange Originals® is not responsible for damage or personal injury due to improper installation, custom installation that doesn't follow the instructions, or neglect.

If you need help or are missing a part **DO NOT CALL YOUR DEALER. Contact Lange Originals directly 1-801-262-7322** We offer technical support Monday through Friday 9:00 AM to 4:30 PM Mountain Standard Time. Send us an inquiry via our website [langeoriginals.com](http://langeoriginals.com) or [contact1@langeoriginals.com](mailto:contact1@langeoriginals.com).

Most questions are answered visually by watching the online video for this product. Scan the QR codes or browse to the instructions tab at [langeoriginals.com](http://langeoriginals.com).

### Site Preparation

Determine whether to do a wall mount, or a directly-over-hardtop ceiling mount. The largest determining factor of this is ceiling height. Garages with 7-9 ft ceiling it is recommended that a rear wall installation is done. Garages over 9 ft tall it is recommended that the power unit is installed in an overhead ceiling mount configuration. If your ceiling is anything other than parallel to the floor consult a contractor/professional as additional supports for your power unit will be needed. Plug your power unit into a wall and test it up and down before beginning installation.

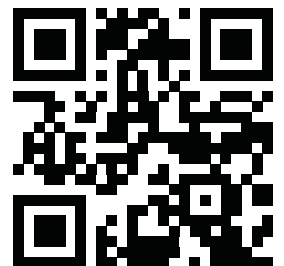

What's this thing? It's a QR code!  
Scan it with your phone  
to get video instructions  
Or go to: [www.langeinstructions.com](http://www.langeinstructions.com)

# Power Unit Ceiling Mount

## 1.) Determine a suitable lifting point:

Back your vehicle in the garage to a suitable parking spot. If you have a Jeep keep enough room to open your tailgate. Run a plumb-bob from the center of your lifting points to the ceiling and mark with a pencil.

## 2.) Install cross bracing:

Using a stud-finder or your preferred method determine the closest stud/TJI set to your plumb-bob mark. Install 2X6 cross braces using provided wood screws (HAT-050) as shown in Fig. C & E

## 3.) Install the pulley:

Install the single line pulley (HAT-116) on one of the 2x6 cross braces using the 4 provided pulley screws (HAT-125). This pulley will need to be offset to line up with the drop cable. See Fig. B/D. Please note that the distance from the center of this pulley to the drop down cable should be 32" apart for Jeep owners. All other vehicles will need this measurement to reflect the distance between your two lifting points.

## 4.) Mounting the power unit:

Install "U" brackets (HDW-053) on the back of the power unit (HAT-021) using the provided bolts and washers that are found in your power unit box (HDW-051/HDW-052/HDW-090). Using a 15/64" drill bit, use your mounting bar (HAT-006) as a template to drill pilot holes into your cribbed cross brace. Install one side of the mounting bar (HAT-006) loosely with the lag bolt (HAT-106) and washer (HAC-023). See Fig. A. Slide power unit onto the open side of the mounting bar. Thread the remaining lag bolt (HAT-106) with washer (HAC-023) through the other end of the mounting bar (HAT-006), and into the pre-drilled wood. Alternate tightening bolts until they are both snug.

## 5.) Wiring:

Extend the cable while keeping tension on the wire to avoid bird-nesting. Thread pulley cable through the hole in the casing (Fig. F) and spool through the offset pulley (Fig. B). Leave the drop cable hanging down, through the metal safety fair-lead, toward the floor (Fig. B/F).



Fig. A



Fig. B

**Ceiling mount  
with perpendicular studs**

Shown as if looking up at  
the ceiling with bare studs/joists

Center the two 2x6's with  
the plumb-bob mark.  
2x6 boards should be  
roughly 27 inches apart for  
Jeeps.

Mount the mounting bar  
(HAT-006) and power unit  
(HAT-021) to one 2x6 and  
one of the single pulleys  
(HAT-116) on another 2x6.  
Mount the pulley offset so  
it lines up with the drop  
cable.

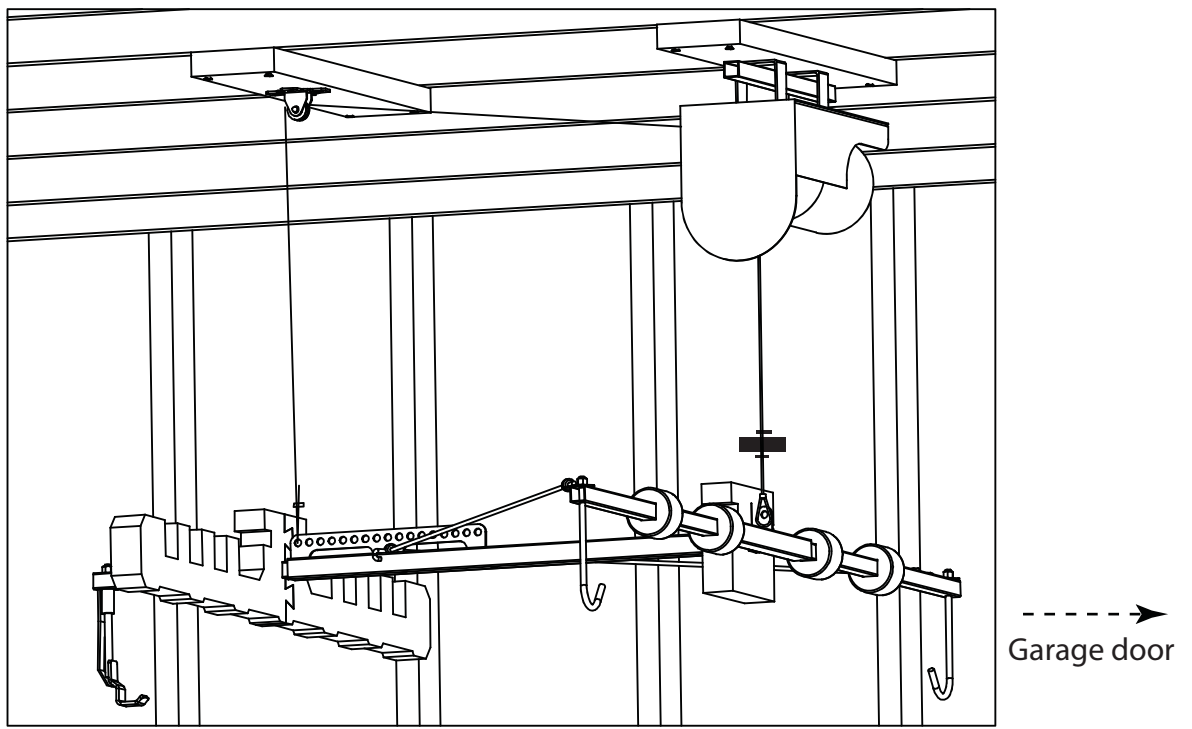
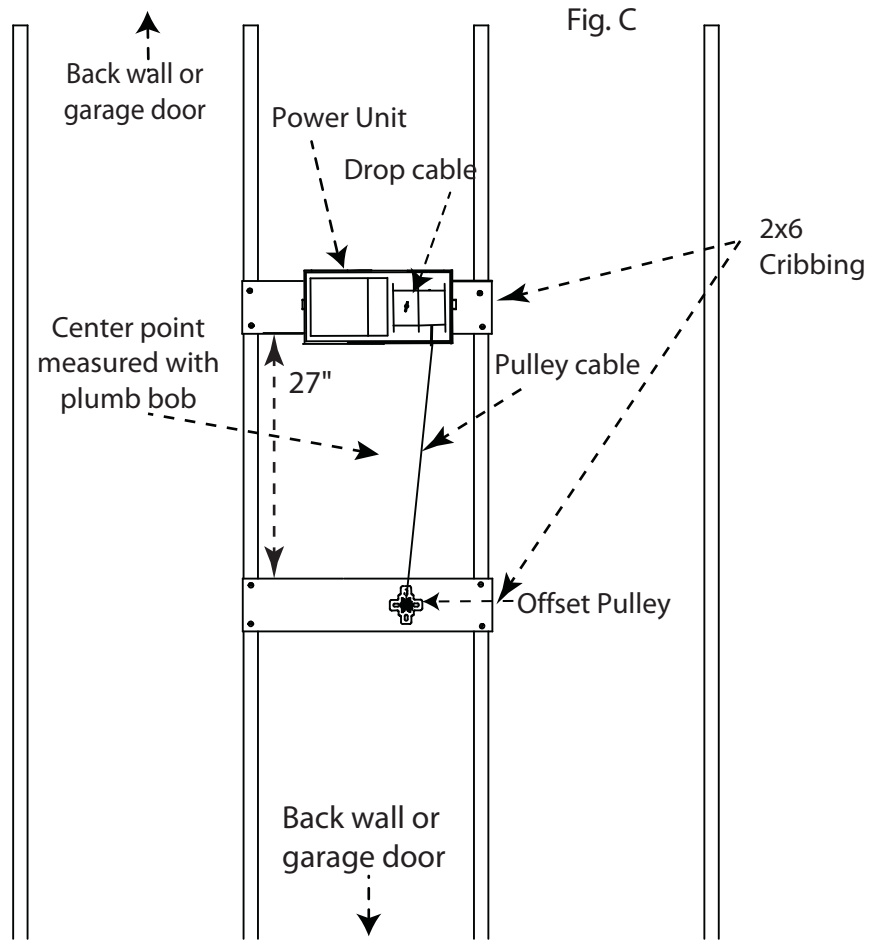

This image reflects the Lange Originals Hoist-A-Top Frame for Jeeps. Your system may vary.

Fig. D

## Ceiling mount with parallel studs

Shown as if looking up at the ceiling with bare studs/joists

Install two cross braced 2x6's between studs (typically 16 or 24 inch). Install mounting bracket as shown in Fig. E spanning the two 2x4's. Install the 2x6 in between two ceiling joists centering it with the drop cable. Install the pulley in the center of this 2x6 board 27 inches from the hoist casing for Jeeps. All other vehicles will need to calculate this measurement according to the distance between their lifting points.

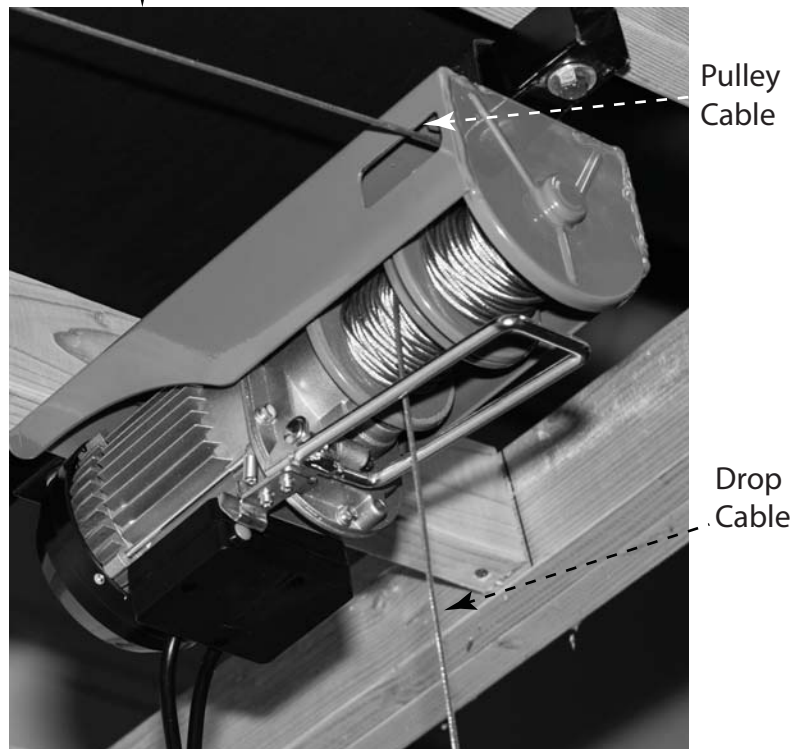
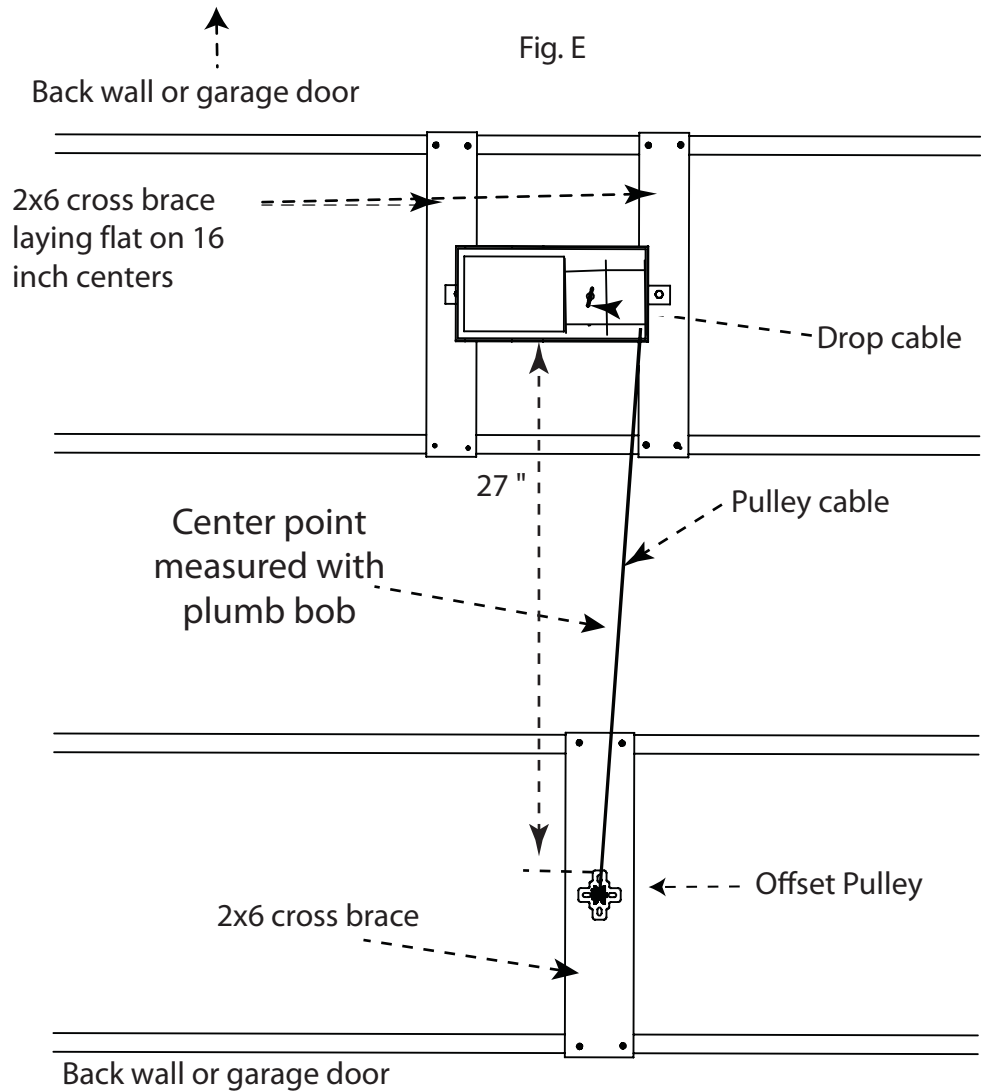

Fig. F

# Power Unit Wall Mount

Fig. A

## 1.) Determine a suitable lifting point:

Back your Jeep into your garage and run a plumb-bob from the center of your hardtop to the ceiling and mark with a pencil. Draw a straight line to the wall you want your power unit on.



## 2.) Install cross bracing and pulleys on ceiling:

Going back to the plumb bob mark, use a stud finder or your preferred method, find which way the studs/joists are running and reference Fig. H/I to install cross braces using provided screws (HAT-050). Install the two pulleys (HAT-116) using screws (HAT-125) on cross braces (Fig. G-I) with 1/2" offset. Keep in mind that the center of the pulleys is your lifting point for removing the top.

## 3.) Install cross bracing on the wall:

Determine the length between wall studs, closest to plumb-bob line. Cut a 2x6 longer than the span and screw it flush with the ceiling with the provided screws (HAT-050).

## 4.) Mounting the power unit:

Install "U" brackets (HDW-053) on the back of the power unit (HAT-021) using the provided bolts and washers that are found in your power unit box (HDW-051/HDW-052/HDW-090). Using a 15/64" drill bit, use your mounting bar (HAT-006) as a template to drill pilot holes into your cribbed cross brace. Install one side of the mounting bar (HAT-006) loosely with the lag bolt (HAT-106) and washer (HAC-023). See Fig. A. Slide power unit onto the open side of the mounting bar. Thread the remaining lag bolt (HAT-106) with washer (HAC-023) through the other end of the mounting bar (HAT-006), and into the pre-drilled wood. Alternate tightening bolts until they are both snug.

## 5.) Wiring:

Once the power unit is firmly mounted, plug it in and pull the cables out while keeping tension. Thread cables through the stop fair-lead. Note that the cable will not go up if the stop fair-lead is interfered with. Thread cable through both pulleys (HAT-116) previously mounted. Make sure the safety stop is on the longest cable and close to the power unit don't install with the cable clamps yet.

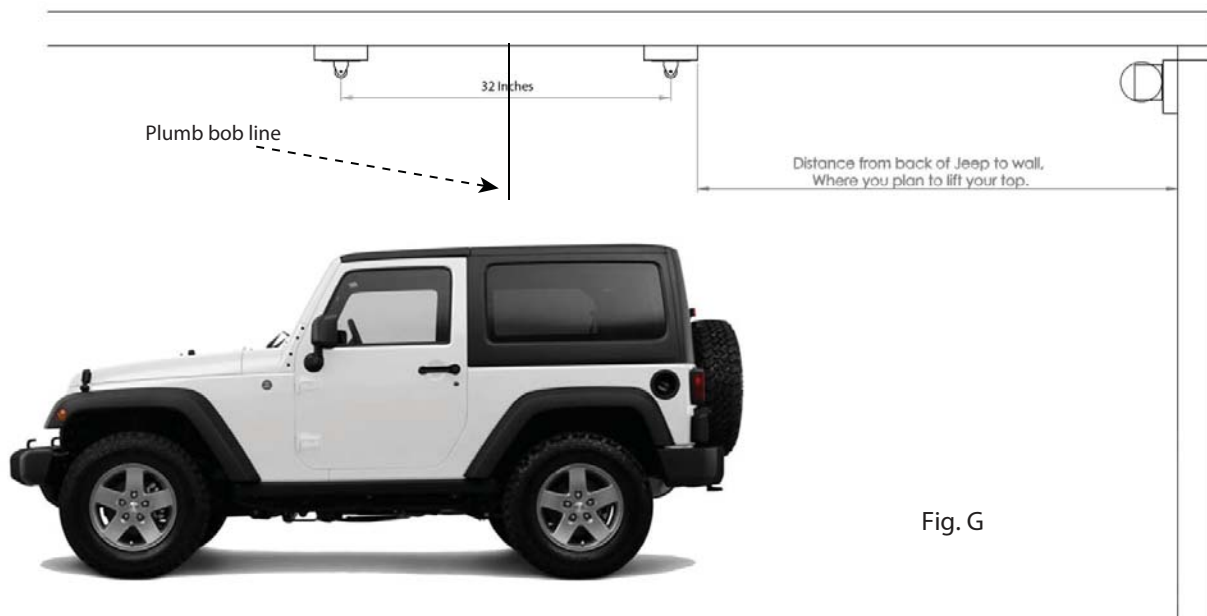

Fig. G

# Wall Mount

Install two cross braced 2x6's between studs centered on the middle mark you drew with your pencil and plumb bob. The pulleys should be installed 32 inches apart for Jeeps. This measurement will vary for all other vehicles. Be sure to have a 1/2 inch offset on the two pulleys. Install 2x6's with provided long screws (HAT-050). These figures are shown as if you were looking up at the ceiling and the studs were exposed

## Perpendicular Stud

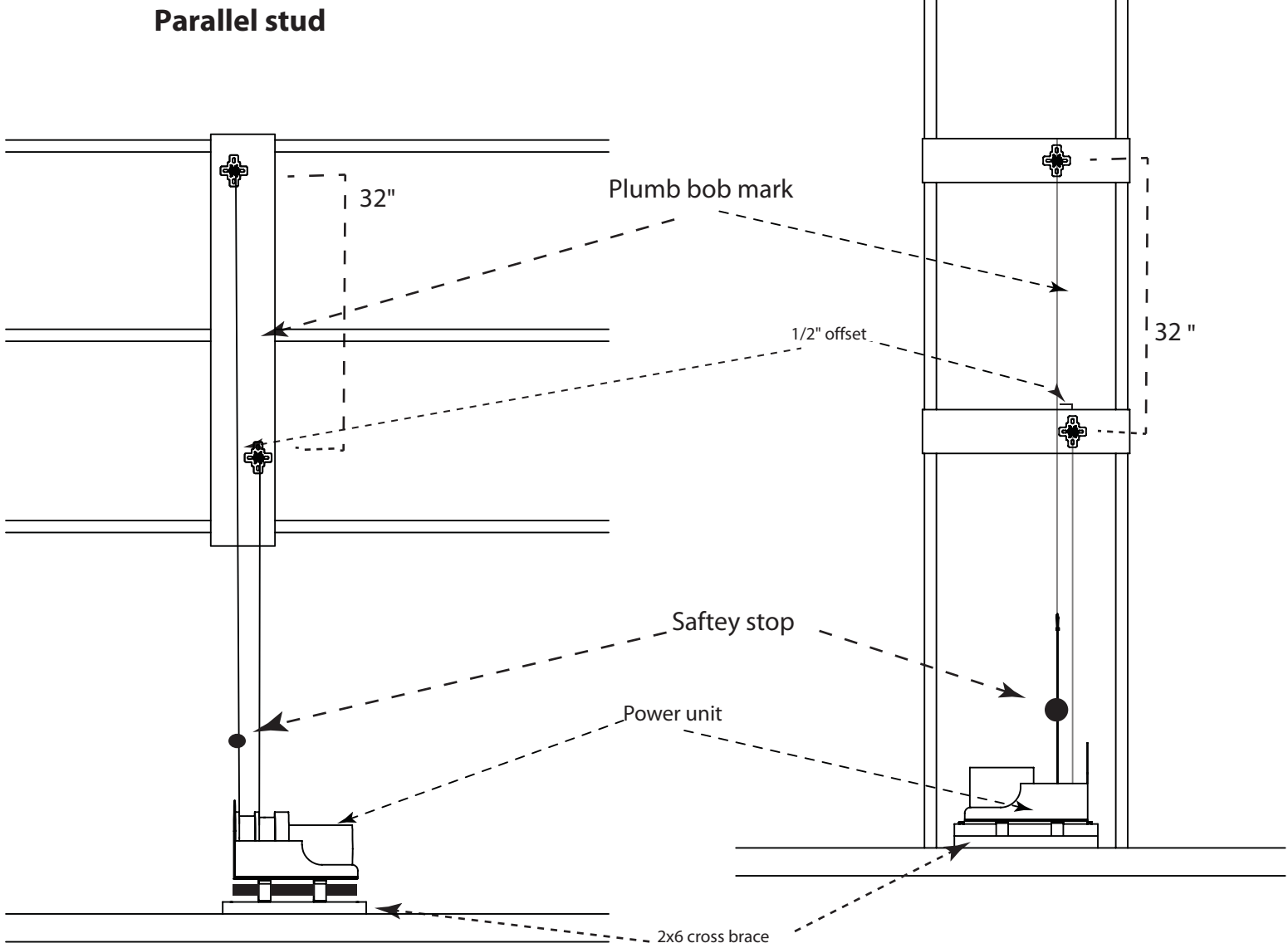

Fig. H

Fig. I



If you have not done so, put your safety stop loosely in place. As shown in Fig. K, feed the cable through the hole with the thimble, install cable clamps loosely at first, in order to balance the frame. With the frame level pull the cable taut and secure the cable clamps in the order shown in figure K. Be careful to not over tighten these as they will strip. If they do become stripped or are suspect do not use them. They can be inexpensively obtained at any hardware store. Inspect these and all hardware before each use. Final leveling of the hard top is achieved by loosening the cable clamps and removing some slack from the dipping side. Do this until the top is parallel to the ceiling. This is a trial and error basis and takes some fiddling, but you only have to do it once. When you are satisfied that the top is level, inspect and tighten all cable clamp bolts.

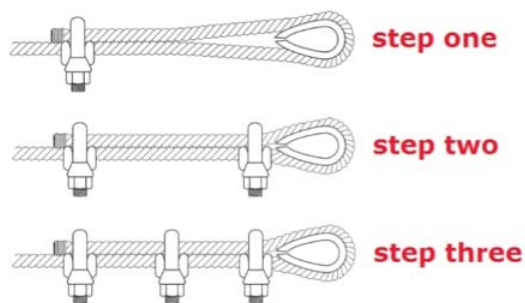

Fig. K

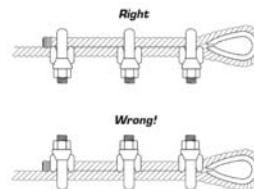

Fig. L

## Glossary of Terms

**Cribbing:** The act of cross bracing perpendicular with a piece of wood. In our case we are laying a 2x6 or wider flat across ceiling or wall joist; securing with four inch decking screws. This is an example of cribbing between wall joists on 16" centers with a 2x6. For ease of install and support we recommend cribbing all power unit installations.



**Plumb-Bob:** A bob of lead or other heavy material forming the weight of a plumb line. It can be as simple as a sharpie or pencil tied to a string.

The documents and instructions in this product are subject to copyright ©2016 all rights reserved. Hoist A Top, Off With Your Top, Lange Originals, are registered trademarks of Lange Originals LLC.

Hoist A Top, Hoist A Cart, Hoist A Top Simple, are protected by the following patent 009932209B2

Chrysler, Dodge, Jeep, Ram, Mopar and SRT are registered trademarks of FCA US LLC. ALFA ROMEO and FIAT are registered trademarks of FCA Group Marketing S.p.A., ©2018 FCA US LLC. All Rights Reserved.



**WARNING:** This product can expose you to bisphenol, a chemical known to the state of California to cause cancer or reproductive harm. For more information go to: [www.p65warnings.ca.gov](http://www.p65warnings.ca.gov)

# Lange Originals Limited Warranty

---

## What the Warranty Covers:

This warranty covers defects from the manufacturing process that would render the product unusable. It also covers items missing from the packaging unless the damage or loss is the result of mishandling by the shipper. This warranty supersedes all other product warranties in the instructions page.

## Who is Covered?

This warranty covers the original purchaser of this device with a invoice of purchase or receipt from a valid current dealer.

## How Long Does the Coverage Last?

This warranty remains in force for one year, to the original purchaser, from the date of purchase on the invoice or receipt. This warranty applies only to approved dealers of Lange's products.

## What We Will do to Correct the Problem:

Lange Originals will repair or replace, at their discretion parts or the whole. Warranty does not cover 3<sup>rd</sup> party labor, or return shipping.

## How do I Get Service?

To obtain warranty repairs, you must obtain authorization from Lange Originals for either a return, or replacement part. If you wish to make other arrangements for repairs/replacement, notify us on our form via our website [langeoriginals.com](http://langeoriginals.com) and click on the warranty tab. We will respond in writing on how to proceed. Please do not contact your dealer, contact Lange Originals directly to avoid delays. Please note you will be asked to provide information such as dealer receipt/invoice and sometimes pictures of the item. Return shipping is not covered. We will ship any repaired or replacement items at no cost.

## Normal Responsibilities of the Buyer:

Buyer is responsible for the inspection and tightening of bolts, nuts, screws, lag screws, gears, pulleys, casters, u-clamps, hooks and any other parts that require regular attention. Lubricating of some parts is necessary such as the crank type worm gear, on crank type lifting units.

---

## This Warranty Does Not Cover:

---

1. Any defect caused by abuse, misuse, neglect, carelessness, or accident.
  2. Loss of time, loss of use, towing charges, bus fare, car rentals, labor costs of installers, or other incidental damages of property.
  3. Damage as a result of not properly following directions, or common safety practices with tools, ladders, and other instruments or tools during installation.
  4. Deterioration from wear or exposure.
  5. Any defect caused by alteration or modification of the home/garage.
  6. Any defect which would not have occurred if instructions in the instruct manual had been followed.
  7. Failure of an Chrysler product due to lack of understanding. For example if a buyer does not correctly unfasten electrical cables
  8. All disputes concerning this warranty would take place in Utah courts and under Utah law.
  9. Shipping damage is covered under our customer satisfaction 30 day return policy, but is not covered after this period of time.
  10. Minor cosmetic issues such as paint flaws, mis-shaped foam pieces that do not affect the function of the product as determined by Lange.
- 

Lange Originals LLC reserves the right to change this document at any time and is not limited to the terms and conditions described here.