



THE
POWER
SPEAKER

ULTRA

USER MANUAL

INTRODUCTION

INTRODUCTION	1
UNIT AT A GLANCE	2
FEATURES AT A GLANCE	4
QUICK START GUIDE	5
BLUETOOTH MODE	6
USB/MICRO SD MODE.....	7
MULTI-LINK MODE	8
AUX IN MODE	9
LIGHT SHOW	9
SOUND PROFILES	9
SAFETY GUIDELINES	10
FAQ & ADDITIONAL RESOURCES	11
SUPPORT	11
LIMITED WARRANTY	11
SPECIFICATIONS	11

INTRODUCTION

Welcome to your new Raycon Power Speaker Ultra!

At Raycon, we develop and design innovative electronics so you can move and conquer your daily fast-paced life.

Before using your product, we strongly encourage you to fully read through this user guide. You can also visit our support center at **www.rayconglobal.com/support**.

This web page has more specific guidelines and helpful videos for you to navigate your product.

For best performance, charge fully before first use.

Pairing ID: The Power Speaker Ultra

We are Raycon. We create carefully crafted wireless audio products for go-getters who need tech that keeps up with them.

We teamed up with expert engineers, leading taste-makers, and platinum artists to design products you'll love to use.

We believe in the the early risers and the one-more-milers of the world. Premium audio, inspired by you.

UNIT AT A GLANCE

SPEAKER

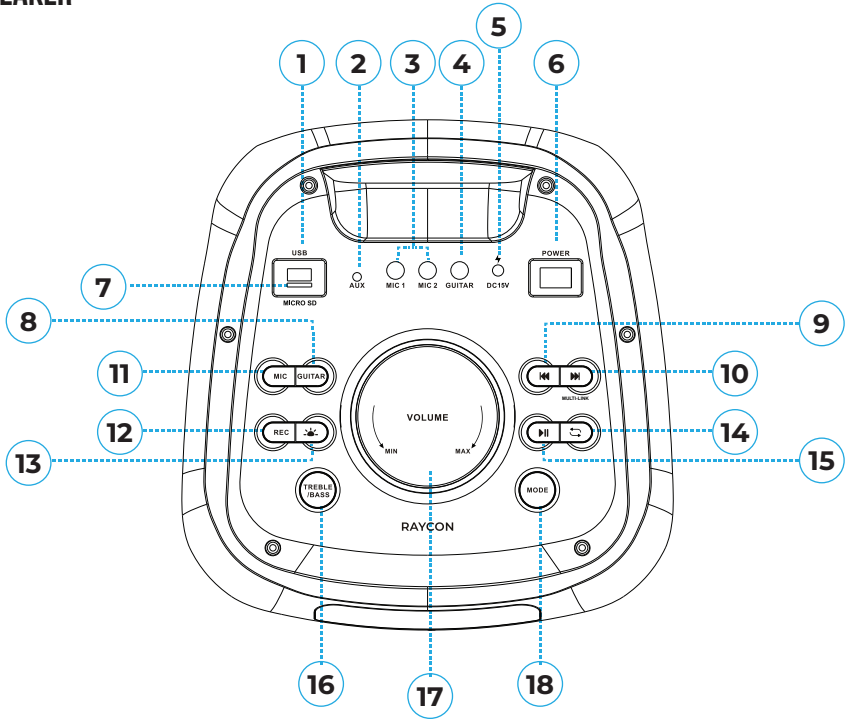

CONTROL PANEL TOP VIEW

- | | |
|--------------------|-------------------------|
| 1. USB Port | 10. Next / Multi-link |
| 2. AUX-IN Port | 11. Microphone Settings |
| 3. Mic Port | 12. Record |
| 4. Guitar Port | 13. Light Show |
| 5. Charging Port | 14. Repeat |
| 6. Power Switch | 15. Play/Pause |
| 7. Micro SD Port | 16. Treble/Bass |
| 8. Guitar Settings | 17. Main Volume |
| 9. Previous | 18. Mode |

REMOTE

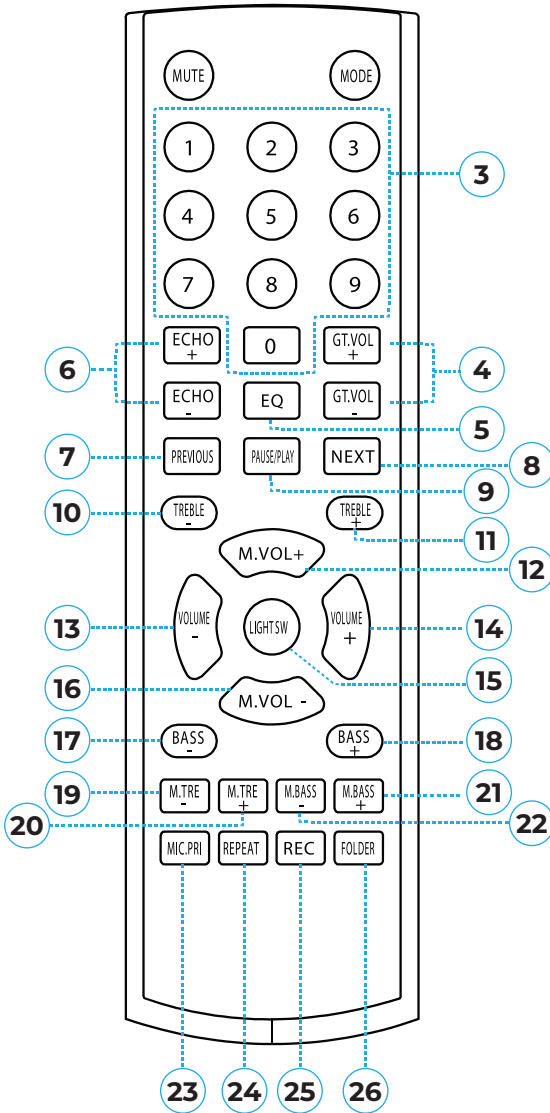

1. Mute
2. Mode
3. Number Buttons
4. Guitar Volume +/-
5. Sound Profiles
6. Echo +/-
7. Previous Song
8. Next Song
9. Pause/Play
10. Treble -
11. Treble +
12. Microphone Volume +
13. Main Volume -
14. Main Volume +
15. LED Light
16. Microphone Volume -
17. Bass -
18. Bass +
19. Microphone Treble -
20. Microphone Treble +
21. Microphone Bass -
22. Microphone Bass +
23. Microphone Priority
24. Repeat
25. Record
26. Folder

FEATURES AT A GLANCE



Party Sound with Customizable EQ

Enough boom to fill any space and a fully customizable EQ to make it sound your way.



Four Audio Modes

Listen your way with four audio modes including Bluetooth, AUX, USB, Micro SD. No matter the source the Power Speaker Ultra has got you covered.



Three 1/4" Inputs (2 Microphone, 1 Guitar)

With the Power Speaker Ultra you're not just listening to mind-blowing sound, you're creating it. Let your voice be heard or play a tune by plugging in a wired mic or guitar.



Multi-link Mode

Multi-link mode gives you the ability to link 2 speakers together via Bluetooth to create soundscapes that fill your space.



Liquid Flame Light Show

The Power Speaker Ultra lets you bring the club wherever you go, with 3 awe-inspiring liquid flame lighting effects.



Three Sound Profiles

The Power Speaker Ultra has three sound profiles that let you control the sound you hear based on the vibe you're trying to create.

QUICK START GUIDE

1. Power on speaker and press “MODE” until speaker enters Bluetooth Pairing Mode.

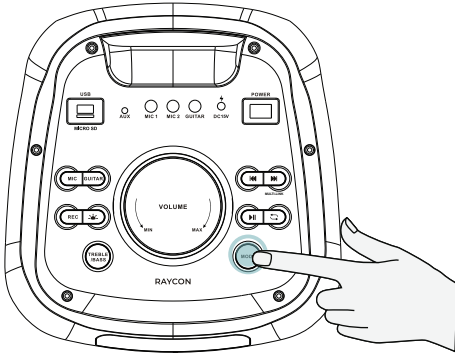

2. From the source device, go to Bluetooth settings and ensure Bluetooth is on. Search for "The Power Speaker Ultra" and select it to pair.



3. Enjoy your Raycon Power Speaker Ultra!

BLUETOOTH MODE

Press “” until speaker enters Bluetooth Pairing Mode and successfully pair with the source device using the Quick Start Guide.

Play/Pause

Press

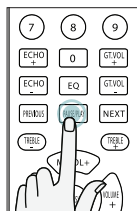
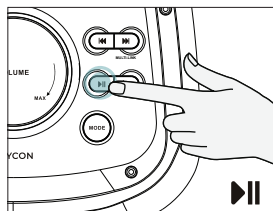

Previous

Press

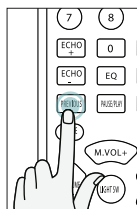
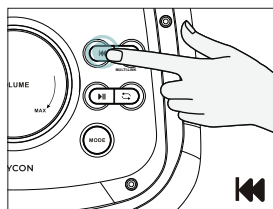

Next

Press

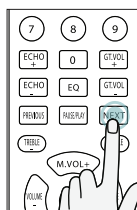
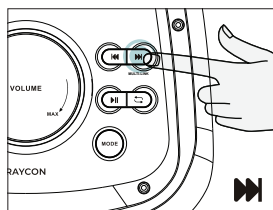

Note: The REPEAT button on the remote has no function while the speaker is in Bluetooth mode.

USB/MICRO SD MODE

Insert USB Drive or Micro SD card into the designated port. The speaker will automatically read and play the music in the drive.

Play/Pause

Press

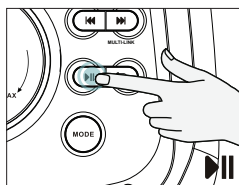

OR

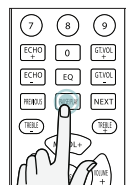

Previous

Press

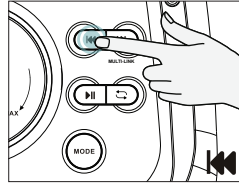

OR

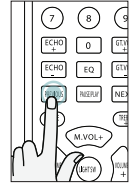

Rewind

Hold for 3 sec

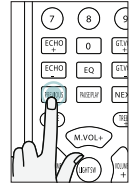

Next

Press

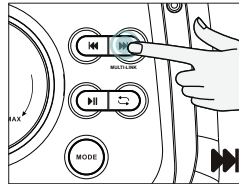

OR



Fast Forward

Hold for 3 sec



Repeat Track

Press

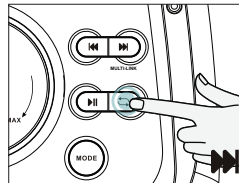

OR

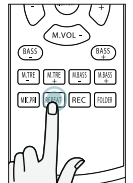

Record

Press

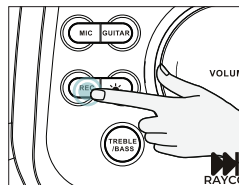

OR

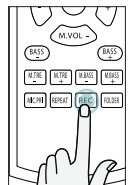

AUX-IN MODE

Press “” until speaker enters AUX mode, and connect the source device to the speaker using a 3.5mm AUX Cable. While speaker is in AUX Mode, all media functions are controlled from the source device.

LIGHT SHOW

Press “” button on the speaker or “LIGHT SW” button on the remote to toggle between the 3 liquid flame light show patterns.

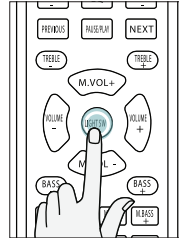
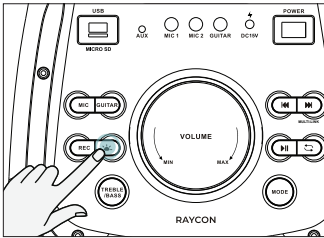

SOUND PROFILES

Your sound, your way! As our sound profiles were crafted by artists and producers at the top of the industry, you're in good hands.

Press “**EQ**” button on the remote to toggle between Sound Profiles.

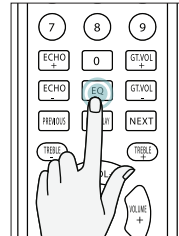

PURE SOUND

Our most refined sound, perfect clarity to hear every single note.

BALANCED SOUND

A leveled sound that is great for all around performance and clarity.

BASS SOUND

Our bass boosted sound, great for songs with strong beats and a go-to for bass lovers.

MULTI-LINK MODE

Pair two speakers together with Multi-link Mode.

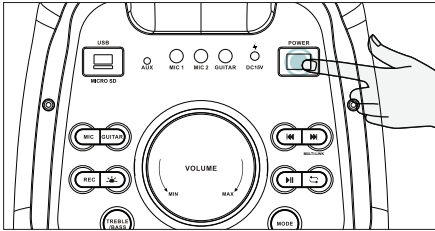

1. Power on both speakers.

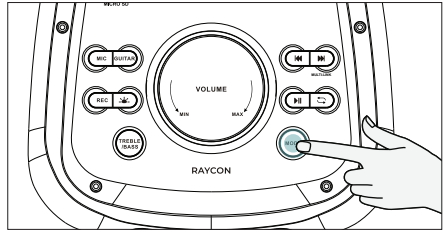

2. Switch speakers into Bluetooth Mode, and ensure they are not connected to any device.

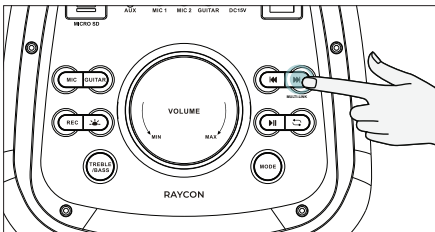

3. Hold “▶▶” for 3 seconds on one speaker to enter Multi-link Mode. A voice prompt will indicate if speakers are connected successfully.



4. From the source device, search for "The Power Speaker Ultra" and select it to pair.

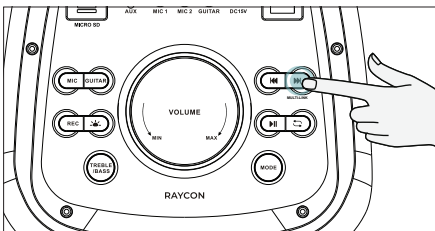

5. Enjoy your Raycon Speakers with Multi-link Mode! Hold “▶▶” for 3 seconds to unpair speakers.

SAFETY GUIDELINES

- Be wary of any edges, uneven surfaces, and metal parts, including on accessories and product packaging, to prevent any possible injury or damage.
- Listen to music at a proper volume to avoid damaging your hearing and speaker.
- Do not store in high temperatures, such as in a hot vehicle or in direct sunlight.
- Store in cool and dry area.
- Do not drop or cause undue impact to the speaker.
- Do not modify, repair, or dismantle the product on your own.
- Do not expose speaker and any of its supplied parts to liquid.
- Do not expose the speaker to water while charging, as doing so may result in damage to the speaker or the power source.
- When storing, keep the unit in an upright position.
- When cleaning this speaker, use a soft dry cloth. For more severe stains, dampen the cloth with water only. Anything else increases the chance of dissolving the paint or damaging the plastic.

FAQ & ADDITIONAL RESOURCES

Visit: www.rayconglobal.com/support

SUPPORT

If your device is not functioning correctly, please visit www.rayconglobal.com/support for customer support, and we will be more than happy to help you.

LIMITED WARRANTY

Visit: www.rayconglobal.com/warranty

SPECIFICATIONS

Model Number: RBS952

RDID: D952-21E-Q321

Bluetooth Version: V5.0

Speaker Size: 8"x2, 3"Tweeter

Speaker Power: 100W

Play Time: up to 10 hours

Bluetooth Pairing ID: The Power

Speaker Ultra

Battery Capacity: 5.5A Lead-acid

Frequency Response: 50Hz - 20kHz

Bluetooth Range: Up to 10 Meters

FCC WARNING

This device complies with part 15 of the FCC Rules. Operation is subject to the following two conditions: (1) this device may not cause harmful interference, and (2) this device must accept any interference received, including interference that may cause undesired operation. Any changes or modifications not expressly approved by the party responsible for compliance could void the user's authority to operate the equipment.

NOTE: This equipment has been tested and found to comply with the limits for a Class B digital device, pursuant to Part 15 of the FCC Rules. These limits are designed to provide reasonable protection against harmful interference in a residential installation. This equipment generates, uses and can radiate radio frequency energy and, if not installed and used in accordance with the instructions, may cause harmful interference to radio communications. However, there is no guarantee that interference will not occur in a particular installation. If this equipment does cause harmful interference to radio or television reception, which can be determined by turning the equipment off and on, the user is encouraged to try to correct the interference by one or more of the following measures:

- Reorient or relocate the receiving antenna.
- Increase the separation between the equipment and receiver.
- Connect the equipment into an outlet on a circuit different from that to which the receiver is connected.
- Consult the dealer or an experienced radio/TV technician for help.

The device has been evaluated to meet general RF exposure statement.

The device can be used in portable exposure condition without restriction

FCC ID: 2AZOV-RBS952

IC Caution:

Radio Standards Specification RSS-Gen, issue 5

- English:

This device contains licence-exempt transmitter(s)/receiver(s) that comply with Innovation, Science and Economic Development Canada's licence-exempt RSS(s). Operation is subject to the following two conditions:

This device may not cause interference.

This device must accept any interference, including interference that may cause undesired operation of the device.

RF exposure statement:

The equipment complies with IC Radiation exposure limit set forth for uncontrolled environment. This equipment should be installed and operated with minimum distance 20cm between the radiator and your body.

- French:

Cet appareil contient des émetteurs / récepteurs exemptés de licence conformes aux RSS (RSS) d'Innovation, Sciences et Développement économique Canada. Le fonctionnement est soumis aux deux conditions suivantes:

Cet appareil ne doit pas causer d'interférences.

Cet appareil doit accepter toutes les interférences, y compris celles susceptibles de provoquer un fonctionnement indésirable de l'appareil.

Déclaration d'exposition RF:

L'équipement est conforme à la limite d'exposition aux radiations de la IC établie pour un environnement non contrôlé. Cet équipement doit être installé et utilisé avec une distance minimale de 20 cm entre le radiateur et votre corps.



@rayconglobal