

YEAR
2000
COMPLIANT

C **UL** US

CE

MADE IN
USA

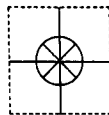

User's Guide

omega.comTM
Ω OMEGA®

www.omega.com
e-mail: info@omega.com

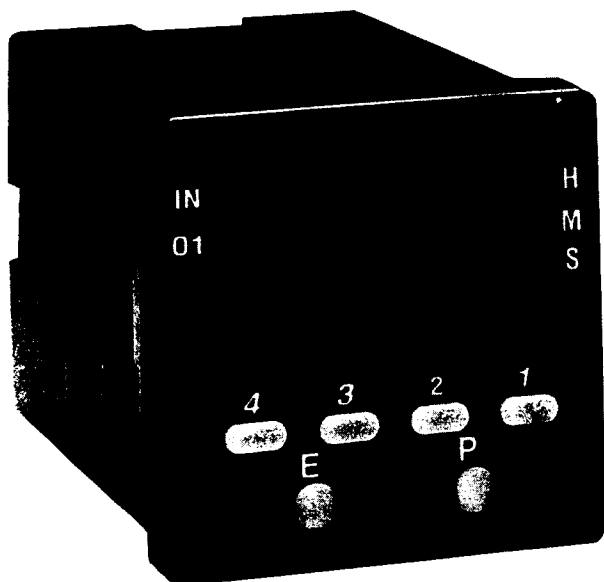

PTC-21 SERIES **1/16 DIN Multi-Programmable** **Dual Display Timers**



OMEGAnet® On-Line Service
www.omega.com

Internet e-mail
info@omega.com

Servicing North America:

USA:
ISO 9001 Certified

One Omega Drive, Box 4047
Stamford CT 06907-0047
Tel: (203) 359-1660
e-mail: info@omega.com

FAX: (203) 359-7700

Canada:

976 Bergar
Laval (Quebec) H7L 5A1
Tel: (514) 856-6928
e-mail: info@omega.ca

FAX: (514) 856-6886

For immediate technical or application assistance:

USA and Canada: Sales Service: 1-800-826-6342 / 1-800-TC-OMEGA®
Customer Service: 1-800-622-2378 / 1-800-622-BEST®
Engineering Service: 1-800-872-9436 / 1-800-USA-WHEN®
TELEX: 996404 EASYLINK: 62968934 CABLE: OMEGA

Mexico:

Tel: (001) 800-826-6342
En Español: (001) 203-359-7803

FAX: (001) 203-359-7807
e-mail: espanol@omega.com
info@omega.com.mx

Servicing Europe:

Benelux:

Postbus 8034, 1180 LA Amstelveen, The Netherlands
Tel: +31 20 6418405
Toll Free in Benelux: 0800 0993344
e-mail: nl@omega.com

FAX: +31 20 6434643

Czech Republic:

Rudé armády 1868, 733 01 Karviná 8
Tel: +420 (69) 6311899
Toll Free: 0800-1-66342

FAX: +420 (69) 6311114
e-mail: czech@omega.com

France:

9, rue Denis Papin, 78190 Trappes
Tel: +33 130-621-400
Toll Free in France: 0800-4-06342
e-mail: france@omega.com

FAX: +33 130-699-120

Germany/Austria:

Daimlerstrasse 26, D-75392 Deckenpfronn, Germany
Tel: +49 (07056) 3017
Toll Free in Germany: 0800 TC-OMEGASM
e-mail: germany@omega.com

FAX: +49 (07056) 8540

United Kingdom:
ISO 9002 Certified

One Omega Drive, River Bend Technology Centre
Northbank, Irlam, Manchester
M44 5EX United Kingdom
Tel: +44 (0)161 777 6611
Toll Free in United Kingdom: 0800-488-488
e-mail: sales@omega.co.uk

FAX: +44 (0)161 777 6622

It is the policy of OMEGA to comply with all worldwide safety and EMC/EMI regulations that apply. OMEGA is constantly pursuing certification of its products to the European New Approach Directives. OMEGA will add the CE mark to every appropriate device upon certification.

The information contained in this document is believed to be correct, but OMEGA Engineering, Inc. accepts no liability for any errors it contains, and reserves the right to alter specifications without notice.

WARNING: These products are not designed for use in, and should not be used for, patient-connected applications.

OVERVIEW

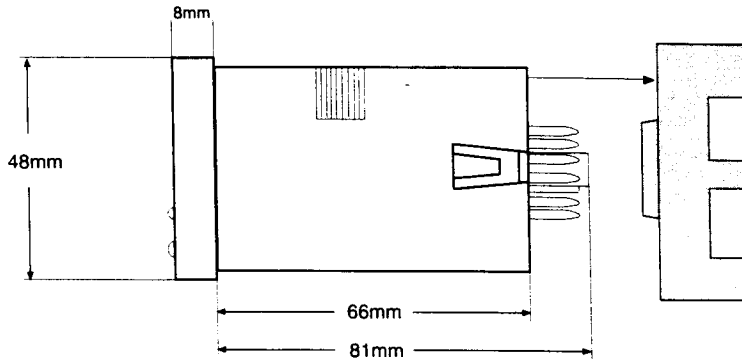

To wire the unit, an 11 pin socket is required. The unit can either be DIN rail mounted or panel mounted using the supplied mounting bracket. For panel mounting, place the unit in the cutout, then slide the bracket forward over the rear of the unit so that the tabs catch in the grooves on the housing and the bracket is as far forward as possible. Tighten the panel mount screws until there is a snug fit against the panel. Do not overtighten.

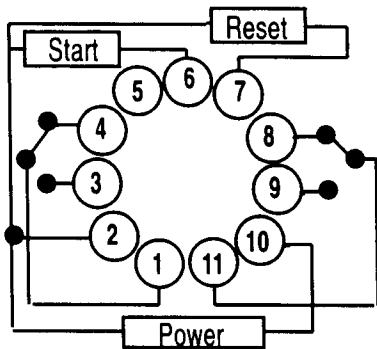

Warning: Do Not connect a coil in parallel with the start signal. Such a connection will cause the start signal to be continuously active. This situation also applies to the Reset input.

O V E R V I E W

FRONT PANEL OPERATION

I/O Status Indicators

Illuminates to display when an input or output is active: "IN" for the start input, "O1" and "O2" for the timed outputs.

Time Value

Indicates the elapsed/remaining time to preset.

Edit Key

In Control Mode: With "P" key, resets the displayed value.

In Program Mode: Scrolls between the applicable choices for the currently displayed parameter.

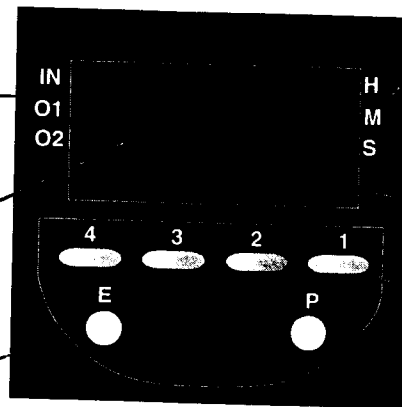

Time Range Indicator

Illuminates to show the time base: H for hours, M for minutes, S for seconds. Multiple indicators will be illuminated when the time base is Hours:Minutes or Minutes:Seconds.

Set Value

Settable value used to trigger the timed output.

Numeric Keys

Each of the number keys is used to increment the value of the corresponding digit of the preset or a parameter value

Program Key

In Control Mode: Depressing the key will scroll the display among the preset and batch displays. Holding the key down for 3 seconds will shift the unit into Program Mode. With the "E" key, resets the displayed value

In Program Mode: Depressing the key will scroll the display from one parameter to the next. Holding the key down for 3 seconds will shift the unit to Control Mode.

PROGRAMMING

- Enter the Program Mode by holding down the "P" key for 3 seconds
- Press the "P" key to move the top display from one parameter to the next
- Press the "E" key to scroll the bottom display through the available choices for that parameter
- While in Program Mode, the unit will reset; the new settings will only become effective after returning to Control Mode by holding down the "P" key for 3 seconds
- If there is no key activity for 60 seconds, the unit will automatically return to Control Mode and continue to run under the previous settings

P
○ For 3 Seconds

Func
OndL

Operating Function: Determines how outputs will operate in relation to the set value. Choices are:

- On-Delay (OndL)
- Off Delay (OFdL)
- Interval (int)
- Repeat Cycle (CYCL)
- Delay/Interval (dint)

See Page 5 for timing charts.

P
○

FrSt
On

Note: The following parameter will only appear if Repeat Cycle is chosen as the Operating Function.

First Operation: Determines whether the Repeat Cycle will start with an On or an Off Operation.

P
○

int
1.0s

Note: The following parameter will only appear if Delay/Interval is chosen as the Operating Function.

Interval Time: Sets the amount of time the output will be active after the On-Delay function has timed out. Use the 1 through 4 keys to set the value in a range from 0.1 to 999.9 seconds.

P
○

trnG

Time Range: Sets the unit of measure for the time values that will be shown on the display in Control Mode. Choices are:

- Seconds
- Minutes
- Hours
- Minutes:Seconds
- Hours:Minutes

P
○

decP

Note: The following parameter will not appear if Minutes:Seconds or Hours:Minutes is selected as the time range.

Decimal Position: Sets the decimal position for the time display. Choices are: no decimal point (0), 10ths position (0.0), or Hundreths position (0.00). The time range selected in the previous parameter will remain illuminated for reference.

PROGRAMMING

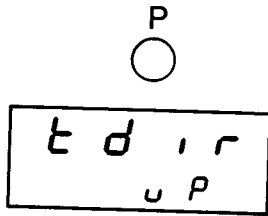

Timing Direction: Determines whether the time value will increment from zero and change the state of the output at the set value (uP) or decrement from the set value and change the state of the output at zero (dn).

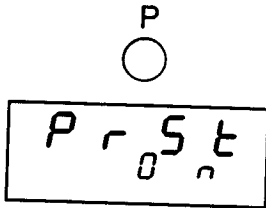

Power Reset Enable: After a loss of power the unit can be programmed to either reset upon reapplication of power (On) or continue from the point of power interruption (Off).

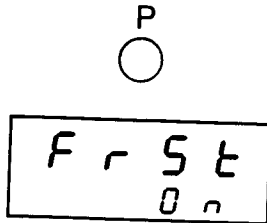

Front Panel Reset Enable: When active (On), the timing operation can be reset in Control Mode by simultaneously pressing the "E" and "P" keys. If inactive (Off), the timing operation can only be reset through the remote input.

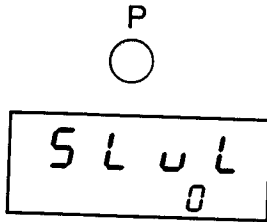

Security Level: 4 different levels of security are available:

0 = Full Access

1 = SP Locked Out

2 = Access to Program Mode only by holding the "P" key for 10 seconds

3 = SP Locked Out and access to Program Mode only by holding the "P" key for 10 seconds

OPERATING MODES

TIMING DIAGRAMS

On-Delay

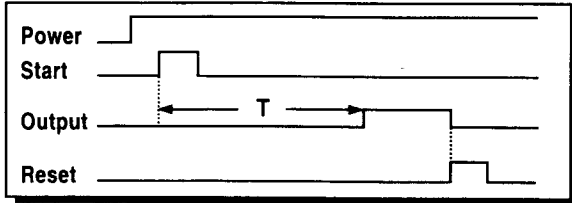

Timing begins on the leading edge of the start input. The output will activate at the completion of the preset time (T) and will remain active until the reset signal is applied or power is interrupted*.

Off-Delay

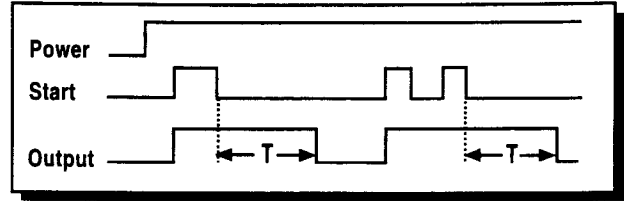

The output is activated at the leading edge of the start signal. Timing begins on the trailing edge. The output will remain active until the preset time (T) has elapsed or power is interrupted*. Reapplying the start signal before T has elapsed will reset the time value. The reset input is not used.

Interval

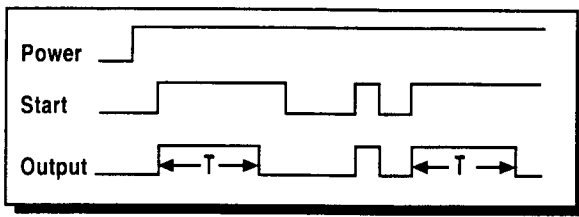

On the leading of the start input, the output is activated and timing begins. The output will remain active until the preset time (T) has elapsed, the reset signal is applied or power is interrupted*. Removal of the start signal will also cause the output to be deactivated and the time value reset.

Repeat Cycle

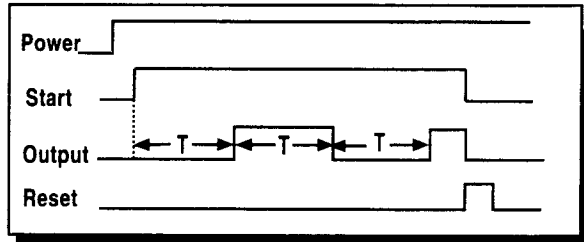

Timing begins on the leading edge of the start signal. A cycle is initiated where the output will be OFF for the preset time (T), then ON for the preset time. This cycle will continue until the start signal is removed, a reset signal is applied or power is interrupted*. The unit can also be programmed for the timing sequence to begin with an ON cycle.

ON Delay/Interval

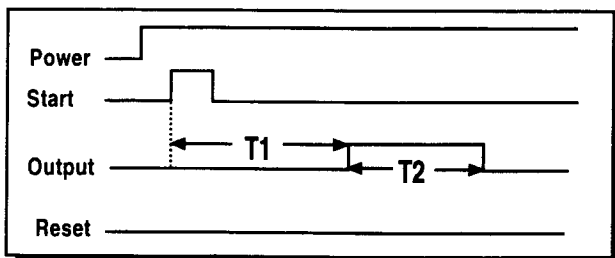

The delay cycle begins upon application of the start signal. The output will activate at the completion of the preset time (T1). Upon activation of the output the Interval cycle will begin. The output will be deactivated at the end of the Interval time (T2). T1 is the primary preset value and is set in Operation Mode. T2 is set in Program Mode in a range from 0.1 to 999.9 seconds. The timing sequence and output can also be reset through the reset input or interruption of power*.

* The Power Reset parameter in Program Mode can be set so that a timing sequence will not be reset upon power interruption but instead continue on when power is restored.

GENERAL

SPECIFICATIONS

Inputs

Start: NPN or Dry Contact
Reset: NPN or Dry Contact
Activation Time: 4 ms (PTC-21-LV), 21 ms (PTC-21)
Impedance: 10 K Ω

Outputs

Timed: DPDT (5 amp)

Physical

Dimensions: 48mm x 48mm, 85mm deep
Mounting: Panel Mounting 45mm x 45mm
cutout, or DIN rail
Wiring Connection: Via 11 pin plug in socket

Operation

Supply Voltage: 90 - 240 VAC 50/60Hz, or 24 VAC/VDC
Power Consumption: < 10 VA
Time Ranges: Hours, Minutes, Seconds, Hours:Minutes, Minutes:Seconds
Resolution: Settable for XXXX or XX.XX for Hours, Minutes and Seconds ranges
Operating Modes: On Delay, Off Delay, Interval, Repeat, Delay/Interval
Repeat Accuracy: $\pm 0.01\%$
Electrical Service Life: 100,000 cycles at full load
Mechanical Service Life: 10 million cycles at min. load
Weight: 100 grams (3.5 ounces)

Environmental

Front Panel Rating: IEC IP65
Operating Temperature: 0° to 55° C (32° to 131° F)
Storage Temperature: -40° to 90° C (-40° to 194° F)
Humidity: 5% to 95% RH non-condensing
Approvals: UL, CUL recognized - File #97337, CE certified

ORDERING INFORMATION

Description

Multi-function Timer, 90- 240 VAC
Multi-function Timer, 24 VAC/VDC

Model

PTC-21
PTC-21-LV

WARRANTY/DISCLAIMER

OMEGA ENGINEERING, INC. warrants this unit to be free of defects in materials and workmanship for a period of **13 months** from date of purchase. OMEGA's WARRANTY adds an additional one (1) month grace period to the normal **one (1) year product warranty** to cover handling and shipping time. This ensures that OMEGA's customers receive maximum coverage on each product.

If the unit malfunctions, it must be returned to the factory for evaluation. OMEGA's Customer Service Department will issue an Authorized Return (AR) number immediately upon phone or written request. Upon examination by OMEGA, if the unit is found to be defective, it will be repaired or replaced at no charge. OMEGA's WARRANTY does not apply to defects resulting from any action of the purchaser, including but not limited to mishandling, improper interfacing, operation outside of design limits, improper repair, or unauthorized modification. This WARRANTY is VOID if the unit shows evidence of having been tampered with or shows evidence of having been damaged as a result of excessive corrosion; or current, heat, moisture or vibration; improper specification; misapplication; misuse or other operating conditions outside of OMEGA's control. Components which wear are not warranted, including but not limited to contact points, fuses, and triacs.

OMEGA is pleased to offer suggestions on the use of its various products. However, OMEGA neither assumes responsibility for any omissions or errors nor assumes liability for any damages that result from the use of its products in accordance with information provided by OMEGA, either verbal or written. OMEGA warrants only that the parts manufactured by it will be as specified and free of defects. OMEGA MAKES NO OTHER WARRANTIES OR REPRESENTATIONS OF ANY KIND WHATSOEVER, EXPRESS OR IMPLIED, EXCEPT THAT OF TITLE, AND ALL IMPLIED WARRANTIES INCLUDING ANY WARRANTY OF MERCHANTABILITY AND FITNESS FOR A PARTICULAR PURPOSE ARE HEREBY DISCLAIMED. LIMITATION OF LIABILITY: The remedies of purchaser set forth herein are exclusive, and the total liability of OMEGA with respect to this order, whether based on contract, warranty, negligence, indemnification, strict liability or otherwise, shall not exceed the purchase price of the component upon which liability is based. In no event shall OMEGA be liable for consequential, incidental or special damages.

CONDITIONS: Equipment sold by OMEGA is not intended to be used, nor shall it be used: (1) as a "Basic Component" under 10 CFR 21 (NRC), used in or with any nuclear installation or activity; or (2) in medical applications or used on humans. Should any Product(s) be used in or with any nuclear installation or activity, medical application, used on humans, or misused in any way, OMEGA assumes no responsibility as set forth in our basic WARRANTY/DISCLAIMER language, and, additionally, purchaser will indemnify OMEGA and hold OMEGA harmless from any liability or damage whatsoever arising out of the use of the Product(s) in such a manner.

RETURN REQUESTS/INQUIRIES

Direct all warranty and repair requests/inquiries to the OMEGA Customer Service Department. BEFORE RETURNING ANY PRODUCT(S) TO OMEGA, PURCHASER MUST OBTAIN AN AUTHORIZED RETURN (AR) NUMBER FROM OMEGA'S CUSTOMER SERVICE DEPARTMENT (IN ORDER TO AVOID PROCESSING DELAYS). The assigned AR number should then be marked on the outside of the return package and on any correspondence.

The purchaser is responsible for shipping charges, freight, insurance and proper packaging to prevent breakage in transit.

FOR **WARRANTY** RETURNS, please have the following information available BEFORE contacting OMEGA:

1. Purchase Order number under which the product was PURCHASED,
2. Model and serial number of the product under warranty, and
3. Repair instructions and/or specific problems relative to the product.

FOR **NON-WARRANTY** REPAIRS, consult OMEGA for current repair charges. Have the following information available BEFORE contacting OMEGA:

1. Purchase Order number to cover the COST of the repair,
2. Model and serial number of the product, and
3. Repair instructions and/or specific problems relative to the product.

OMEGA's policy is to make running changes, not model changes, whenever an improvement is possible. This affords our customers the latest in technology and engineering.

OMEGA is a registered trademark of OMEGA ENGINEERING, INC.

© Copyright 1999 OMEGA ENGINEERING, INC. All rights reserved. This document may not be copied, photocopied, reproduced, translated, or reduced to any electronic medium or machine-readable form, in whole or in part, without the prior written consent of OMEGA ENGINEERING, INC.

Where Do I Find Everything I Need for Process Measurement and Control? OMEGA...Of Course!

TEMPERATURE

- ☑ Thermocouple, RTD & Thermistor Probes, Connectors, Panels & Assemblies
- ☑ Wire: Thermocouple, RTD & Thermistor
- ☑ Calibrators & Ice Point References
- ☑ Recorders, Controllers & Process Monitors
- ☑ Infrared Pyrometers

PRESSURE, STRAIN AND FORCE

- ☑ Transducers & Strain Gages
- ☑ Load Cells & Pressure Gages
- ☑ Displacement Transducers
- ☑ Instrumentation & Accessories

FLOW/LEVEL

- ☑ Rotameters, Gas Mass Flowmeters & Flow Computers
- ☑ Air Velocity Indicators
- ☑ Turbine/Paddlewheel Systems
- ☑ Totalizers & Batch Controllers

pH/CONDUCTIVITY

- ☑ pH Electrodes, Testers & Accessories
- ☑ Benchtop/Laboratory Meters
- ☑ Controllers, Calibrators, Simulators & Pumps
- ☑ Industrial pH & Conductivity Equipment

DATA ACQUISITION

- ☑ Data Acquisition & Engineering Software
- ☑ Communications-Based Acquisition Systems
- ☑ Plug-in Cards for Apple, IBM & Compatibles
- ☑ Datalogging Systems
- ☑ Recorders, Printers & Plotters

HEATERS

- ☑ Heating Cable
- ☑ Cartridge & Strip Heaters
- ☑ Immersion & Band Heaters
- ☑ Flexible Heaters
- ☑ Laboratory Heaters

ENVIRONMENTAL MONITORING AND CONTROL

- ☑ Metering & Control Instrumentation
- ☑ Refractometers
- ☑ Pumps & Tubing
- ☑ Air, Soil & Water Monitors
- ☑ Industrial Water & Wastewater Treatment
- ☑ pH, Conductivity & Dissolved Oxygen Instruments