



**ABLOW**

# MAINTENANCE GUIDE

---



**TECHNO TAKATSUKI CO.,LTD.**

## Introduction

We thank you very much purchasing our **TECHNO TAKATSUKI HIBLOW** air pumps. The introduction of the first **HIBLOW** pump was over twenty years ago. More than 3 million **HIBLOW** pumps have now been produced and found widespread applications. This guide book is explained comprehensible as everyone can repair easily. Can be useful when repairing by all means. Also, please utilize our maintenance tools for replacement.

## What is ISO 9001?

In 1987, the International Organization for Standardization (ISO) established its ISO 9000 standards. These internationally approved standards provide specifications not for products but for quality-assurance systems. ISO 9000 consists of three separate standards: ISO 9001, 9002, and 9003. Of these, ISO 9001 is the most rigorous, encompassing points ranging from design control to after-sales service. To qualify for an ISO 9001 certificate, applicants must first pass in-company, customer, and third-party audits. After receiving ISO 9001 certification, regular checks are then conducted to ensure that the company maintains the required standards. In addition, management policies on product quality are documented and checked against actual practice throughout the entire organization. In essence, the ISO 9001 standard certifies that a company has not only established an outstanding quality-control record, but has also proven capable of sustaining this record.

## The Product Liability Law

Japan's Product Liability Law was introduced in July 1995 in response to the increasing difficulty consumers were having in evaluating the quality of high-technology products and in claiming damages associated with product defects. With the Product Liability Law making it easier for customers to claim damages, manufacturers must now assign a higher priority to quality control. At Techno Takatsuki Co., Ltd., our response to the above developments was to create a program that ensured our products were in compliance with the Product Liability Law. At the same time, we implemented a full range of safety measures. As a result of these efforts, we received ISO9001 certification in December 1995, a testament to the high quality of our product design and manufacturing systems. Despite this initial success, we remain determined to further improve our quality-control system, and look forward to the support of our customers as Techno Takatsuki continues to evolve in years to come.

## Introduction

Introduction .....	Back of cover
What is ISO 9001? .....	Back of cover
Table of Contents .....	1
Caution for Maintenance .....	1
Maintenance tools .....	2
Your Warranty .....	2

## HP Series

<b>HP Series</b> .....	3
Filter Cleaning and Replacement .....	3
Removing Upper Housing .....	4
<b>HP-10/20</b> .....	5
Replacing the Chamber Block .....	6
<b>HP-30/40/50</b> .....	8
Replacing the Chamber Block .....	9
<b>HP-10~50 Replacing the Electromagnet</b> .....	11
<b>HP-60/80</b> .....	13
Replacing the Chamber Block .....	14
Replacing the Electromagnet .....	18
<b>HP-100/120</b> .....	20
Replacing the Chamber Block .....	21
Replacing the Electromagnet .....	27

## List of Spare Parts

HP Series .....	30
-----------------	----

## Trouble Shooting Guide

Trouble Shooting .....	34
Precautions for use .....	35

## Caution for Maintenance

### CAUTION

- When performing operation, be sure to unplug the pump unit first.
- When performing the replacement work, the pump body may be still hot and you may get burnt. Therefore, wait until the pump has been allowed to cool.
- Never carry the pump by the filter cover.

## Maintenance tools

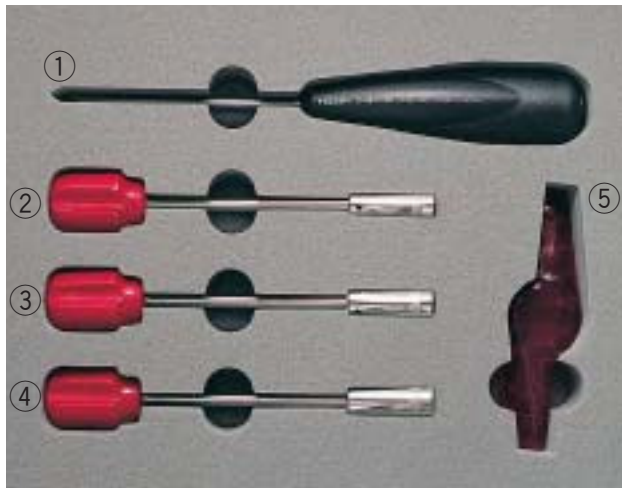

- ① Screw Driver
- ② 5.5mm each side wrench (3mm wrench)
- ③ 7mm each side wrench (4mm wrench)
- ④ 8mm each side wrench (5mm wrench)
- ⑤ Box Driver Handle



With a carrying case.

## Your Warranty

1. Please check a warranty card is supplied and make sure not to lose it.

**A year warranty period.**

**There is a possibility of expense even though the pump is under warranty. Read the warranty card carefully.**

2. We provide a seven-year guarantee on all spare parts even if the pump go out of production.
3. Please make an inquiry about a failure of the pump. Here is a number for customer inquiries.

**TECHNO TAKATSUKI CO., LTD.**

8-16 HATCHO-NISHIMACHI, TAKATSUKI, OSAKA, 569-0095 JAPAN

**TEL : 81-726-84-0805**

**CAUTION**

- When performing cleaning and replacement, be sure to unplug the pump unit first.
- When performing the replacement work, the pump body may be still hot and you may get burnt. Therefore, wait until the pump has been allowed to cool.
- Do not carry the pump by the filter cover.

**STEP 1**

To remove the filter cover, put your fingers on one side of the cover and pull it up.



**STEP 2**

Remove the filter from the upper housing, replace it new one or clean it.

- *At this time, remove any dust or foreign matter from the inlet of the filter cover, and the filter mounting surface and the inlet of the filter.*
- *If the filter is dirty, dust it off well. If it is heavily soiled, use a neutral detergent to wash it, rinse it with water, and dry it well out of direct sunlight before reinstalling.*



**STEP 3**

According to the photo, replace the filter, put the filter cover back on the upper housing, align the fitting boss of the upper housing with its counterpart of the filter cover, then press the filter cover downwards from above to fit it in.

- *Take care not to press the filter cover in its improper position as it may be damaged.*
- *Do this work after every other works have done.*
- *This pump is of a totally oil-less type. Therefore, never put oil or other liquids into the pump inlet.*



**HP series**

- The cleaning of the filter and the exchange method are the same though shape in dependence on the model might be different from the photograph.

STEP 1

Remove all the bolts from the four corners.



STEP 2

If it is difficult to remove it due to the heavily stuck internal seal packing, pry it open by inserting the tip of a flat-head screwdriver into the clearance between the exhaust nozzle and the upper housing.



STEP 3

According to the photo, if the stick is too heavy, raise up the pump body and hit the exhaust nozzle lightly with a hammer.

• *Do not use a metal hammer.*





Air pump	Start of production	Discontinuance of production
HP-10	1999/ 4	-
HP-20	1999/ 4	-

## HP Series

## STRUCTURE AND PART NAMES

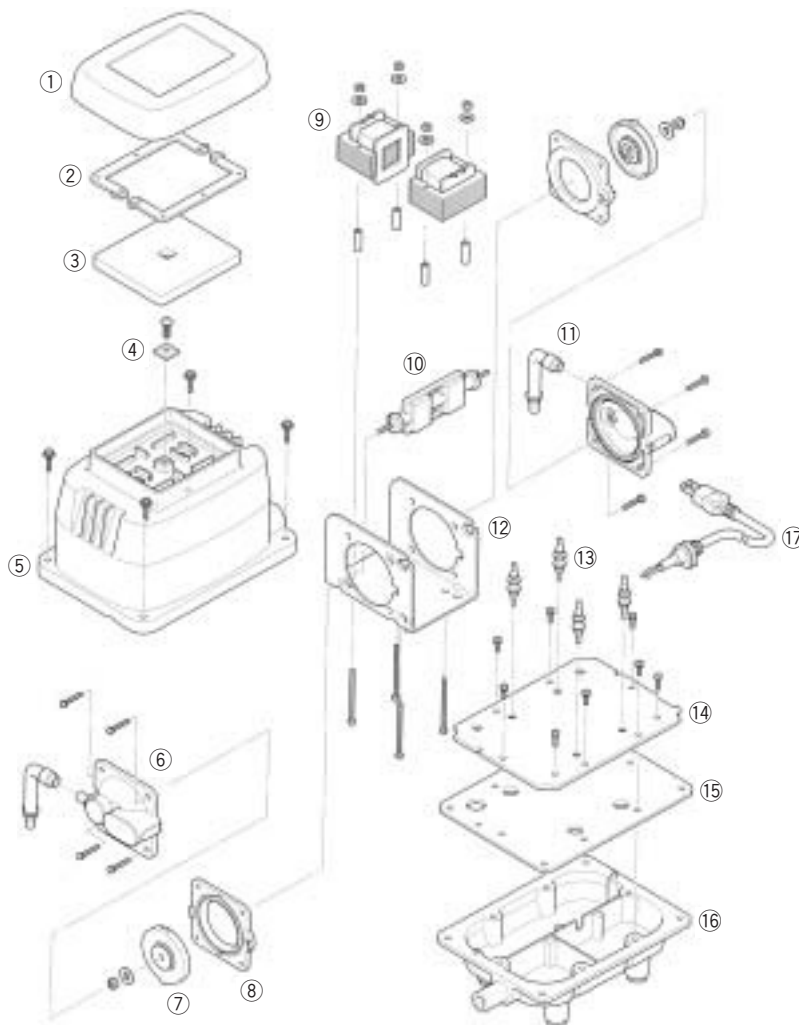

### HP-10/20

- ① Filter Cover
- ② Semi Cover Packing
- ③ Filter
- ④ Fitting Boss
- ⑤ Upper Housing
- ⑥ Casing Block
- ⑦ Diaphragm
- ⑧ Diaphragm Base
- ⑨ Electromagnet
- ⑩ Actuating Rod
- ⑪ L-Tube
- ⑫ Frame
- ⑬ Vibration Control Rubber
- ⑭ Center Plate
- ⑮ Gasket
- ⑯ Lower Housing
- ⑰ Power Cord

**CAUTION**

- When performing the replacement, be sure to unplug the pump unit first.
- Replace the diaphragms and the valves with new ones regularly (every one year or one and half years) in order to maintain their initial performance.
- For chamber block replacement, be sure to change both chamber blocks at the same time.
- The actuating rod employs powerful permanent magnets. Therefore, be sure to remove your watch and precision machine before starting the work as it may fail due to their strong magnetic force.
- Do not put the actuating rod close to a magnetic card, a magnetic disk or any other magnetic media as their data may be lost.

**STEP 1****REMOVAL OF THE CHAMBER BLOCKS**

Remove the upper housing according to the picture on page 17.  
 Remove the L-tube from the casing nozzle.  
 Remove the installation screws of the chamber block. (4 screws on each side.)  
 Remove the casing block.

**STEP 2**

Remove the U-lock nut.

- Use the box driver to loosen (or tighten) the U-lock nut.

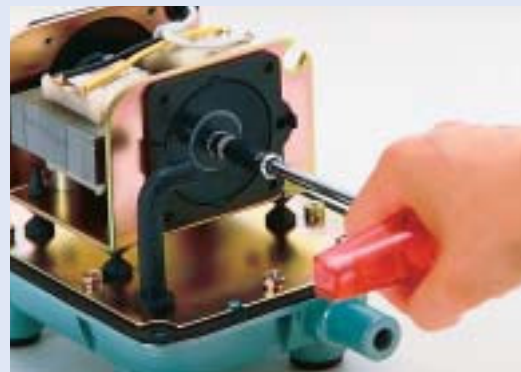
**STEP 3**

Remove one of the diaphragm mounting blocks from the actuating rod, and pull out the other diaphragm mounting block with the rod from the pump body.  
 Remove another U-lock nut and the diaphragm mounting block from the rod.  
 This completes the chamber block removal procedure.





STEP  
4

## FITTING THE CHAMBER BLOCKS

Install a new diaphragm mounting block on the actuating rod.

Set the actuating rod in line with groove and tighten the U-lock nut.

- *Use new U-lock nut and washer only that come as replacement parts to prevent loosening and causing failure of the pump.*

STEP  
5

Insert the actuating rod in accordance with the gap of the frame.

Secure the diaphragm mounting block on other side and tighten with washer and U-lock nut using the box driver.

Make sure the gaps between the actuating rod and the electromagnet are even.

STEP  
6

Connect L-tube to the casing block. Secure the casing block with the screws. (4screws on each side.)

Install the other casing block at the same way.

STEP  
7

Secure the upper housing with the bolts.

Then, replace the filter and filter cover on it.

(See page17 “**FILTER CLEANING AND REPLACEMENT**”)





Air pump	Start of production	Discontinuance of production
HP-30	1998/ 8	—
HP-40	1998/ 8	—
HP-50	1998/12	—

## HP Series

## STRUCTURE AND PART NAMES

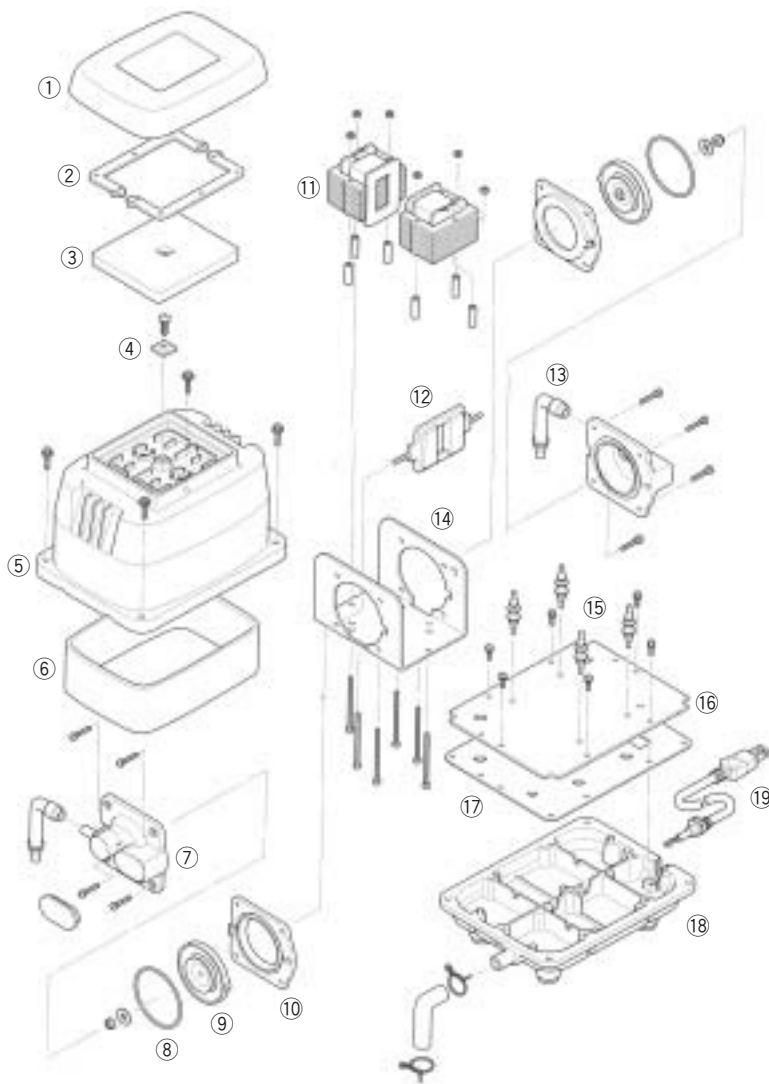

### HP-30/40/50

- ① Filter Cover
- ② Semi Cover Packing
- ③ Filter
- ④ Fitting Boss
- ⑤ Upper Housing
- ⑥ Sound Absorber (HP50)
- ⑦ Casing Block
- ⑧ Diaphragm Ring
- ⑨ Diaphragm
- ⑩ Diaphragm Base
- ⑪ Electromagnet
- ⑫ Actuating Rod
- ⑬ L-Tube
- ⑭ Frame
- ⑮ Vibration Control Rubber
- ⑯ Center Plate
- ⑰ Gasket
- ⑱ Lower Housing
- ⑲ Power Cord

**CAUTION**

- Be sure to unplug the pump unit.
- Replace the diaphragms and the valves with new ones at least once a year or one and a half years in order to maintain their initial performance.
- For chamber block replacement, be sure to change both chamber blocks at the same time.
- The rod employs powerful permanent magnets. Therefore, be sure to remove your watch and precision machine before starting the work as it may fail due to their strong magnetic force.
- Do not put the actuating rod close to a magnetic card, a magnetic disk or any other magnetic media as their data may be lost.

**STEP 1****REMOVAL OF THE CHAMBER BLOCKS**

Remove the upper housing. (See page 18)  
 Remove the sound absorber.  
 Remove the four screws hold the chamber block. (4 screws on each side.)  
 Pull out the L-tube from the casing nozzle and remove the casing block on both side.

**STEP 2**

Remove one of the U-lock nuts hold the diaphragm mounting block to the rod.

- Use the box driver to loosen (or tighten) the U-lock nut.

**STEP 3**

Remove one of the diaphragm mounting block from the rod, and pull out the other diaphragm mounting block with the rod from the pump body.  
 Remove another U-lock nut and the diaphragm mounting block from the rod.

This completes the chamber block removal procedure.



STEP 4

FITTING THE CHAMBER BLOCKS

Install a new diaphragm mounting block on the actuating rod.

Set the actuating rod in line with groove and tighten the U-lock nut with the box driver.

- Use new U-lock nut and washer only that come as replacement parts to prevent loosening and causing failure of the pump.



STEP 5

Insert the actuating rod in accordance with the gap of the frame.

Secure the diaphragm mounting block on other side and tighten with washer and U-lock nut with the box driver.

Make sure the gaps between the actuating rod and the electromagnet are even.



STEP 6

Connect L-tube to the casing block and secure the casing with the screws. (4screws on each side)

Install the other casing block at the same way.



STEP 7

Install the sound absorber. (HP-50)

- Be extremely careful not to pinch the Sound Absorber in the Upper Housing.

Secure the upper housing with the bolts.

Then place the filter and filter cover on the upper housing. (See page17 “FILTER CLEANING AND REPLACEMENT”)



### ⚠ CAUTION

- Be sure to unplug the pump unit.
- When performing replacement work, the pump body may be still hot and you may get burnt. Therefore, wait until the pump has been allowed to cool.
- Be sure to remove the chamber block and the actuating rod before replacing the electromagnet.
- It is better to let an experienced technician handle the soldering process. Take precautions against being burnt.
- In case of HP-10/20, do the same way of replacing the electromagnet.

#### STEP 1

#### REMOVING THE ELECTROMAGNET

Cut the wire from the terminals on the electromagnet with nippers.

- *It is recommended that you make a note of the wiring.*



#### STEP 2

Remove the nuts with the box driver.  
(7mm wrench.)



#### STEP 3

Pull out electromagnets from the pump body.



**STEP 4**

**FITTING THE ELECTROMAGNET**

Secure the electromagnets to the body by the nuts. Use the box driver. (7mm wrench)



**STEP 5**

Tie the wires in a bundle with a silicon tube. Connect the wires to the terminals.



**STEP 6**

Solder the wires to the terminals. The wire requires a soldered connection.



**STEP 7**

This completes the electromagnet replacement procedure.





Air pump	Start of production	Discontinuance of production
HP-60	1995/ 9	—
HP-80	1995/ 9	—

## HP Series

## STRUCTURE AND PART NAMES

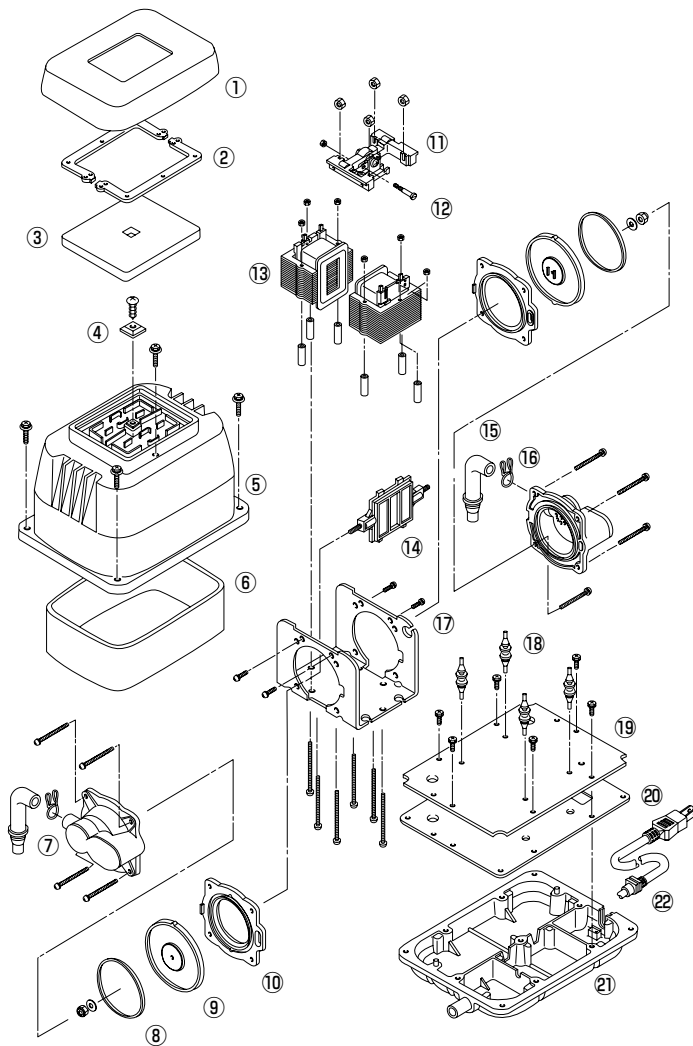

### HP-60/80

- ① Filter Cover
- ② Semi Cover Packing
- ③ Filter
- ④ Fitting Boss
- ⑤ Upper Housing
- ⑥ Sound Absorber
- ⑦ Casing Block
- ⑧ Diaphragm Ring
- ⑨ Diaphragm
- ⑩ Diaphragm Base
- ⑪ SP Switch
- ⑫ Safety Screw
- ⑬ Electromagnet
- ⑭ Actuating Rod
- ⑮ L-Tube
- ⑯ Hose Band
- ⑰ Frame
- ⑱ Vibration Control Rubber
- ⑲ Center Plate
- ⑳ Gasket
- ㉑ Lower Housing
- ㉒ Power Cord

**CAUTION**

- Be sure to unplug the pump unit.
- Replace the diaphragms and the valves with new ones at least once a year or one and a half years in order to maintain their initial performance.
- For chamber block replacement, be sure to change both chamber blocks at the same time.
- The rod employs powerful permanent magnets. Therefore, be sure to remove your watch and precision machine before starting the work as it may fail due to their strong magnetic force.
- Do not put the actuating rod close to a magnetic card, a magnetic disk or any other magnetic media as their data may be lost.

**STEP 1****REMOVAL OF THE CHAMBER BLOCKS**

Remove the Upper Housing.  
(See page18 “REMOVING UPPER HOUSING”)

**STEP 2**

Remove the sound absorber.  
Pull out the L-tube from the casing nozzle.  
Remove the four screws hold the chamber block and the casing block on both side.  
(4screws on each side)

**STEP 3**

Remove one of the U-lock nuts hold the diaphragm mounting block to the rod.

- Use the box driver to loosen (or tighten) the U-lock nut.





**STEP 4**

Remove one of the diaphragm mounting blocks from the actuating rod and pull out the other diaphragm mounting block with the rod and finally, separate the diaphragm mounting block and rod.

This completes the chamber block removal procedure.

- *When pull out the rod, take care not to allow the rod projection to accidentally hit the lever of the SP switch. If the pump stops automatically, the safety screw must be broken to prevent any further damage to the pump. Be sure all debris is removed from unit. (See Step8)*

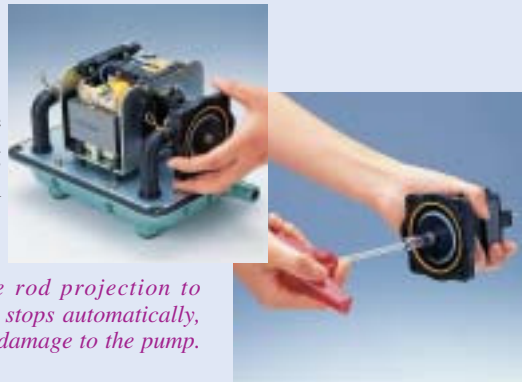

**STEP 5**

**FITTING THE CHAMBER BLOCKS**

Install the new diaphragm mounting block on the actuating rod.

- *Use new U-lock and washer only that come as replacement parts to prevent loosening and causing failure of the pump.*



**STEP 6**

Insert the actuating rod in accordance with the gap of the frame.

Secure the diaphragm mounting block on the other side and tighten the U-lock nut with the box driver.

Make sure the gaps between the actuating rod and the electromagnet are even.



**STEP 7**

Connect L-tube to the casing block and secure the casing with the screws.

(4screws on each side)

Install the other casing block at the same way.



STEP 8

REPLACEMENT OF SAFETY SCREW

Dispose of broken screw.

- *Be sure all debris is removed from unit as it can result in damage to the permanent magnets and or even in a failure of the pump.*



STEP 9

Draw a new safety screw through a hole in the different direction of the terminal.  
(Threading order : The L-shaped lever—the spring electrode)



STEP 10

Fasten the screw with a nut.  
The screw is designed so that the nut will turn freely when it is properly fastened, stop tightening when this happens.



STEP 11

This completes the replacement of the safety screw procedure.  
Make sure the gaps between L-shaped lever and lug of the actuating rod are even.

- *When checking the movement of the switch while the power is connected, touching the terminal will result in an electric shock.*
- *Unplug the pump immediately after the check.*



STEP  
12

Install the sound absorber.

STEP  
13

Place the upper housing back on body.

- *Be extremely careful not to pinch the Sound Absorber in the Upper Housing.*

Secure it with the bolts.

Then place the filter and filter cover on the upper housing. (See page17 “FILTER CLEANING AND REPLACEMENT”)



**CAUTION**

- Be sure to unplug the pump.
- When performing replacement work, the pump body may be still hot and you may get burnt. Therefore, wait until the pump has been allowed to cool.
- Be sure to remove the chamber block and the actuating rod before replacing the electromagnet.
- It is better to let an experienced technician handle the soldering process.

**STEP 1****REMOVAL OF ELECTROMAGNET**

Cut the wire from terminals on the electromagnets with nippers.

- *It is recommended that you make a note of the wiring.*

**STEP 2**

Undo the frame screws and remove the SP switch.

**STEP 3**

Remove the mounting nuts with the box driver.  
(7mm wrench)  
Pull out the electromagnets from the pump body.



**STEP 4**

**FITTING THE ELECTROMAGNET**

Secure the electromagnets to the body by the nuts.  
Use the boxdriver. (wrench)



**STEP 5**

Secure the SP switch to the frame by the screws.

• *Be careful of the direction.*



**STEP 6**

Tie the wires in a bundle with a silicon tube.  
Strip off the coating each of the wires.  
(7mm from the end)  
Connect the wires to the terminals.  
The wire requires a soldered connection.

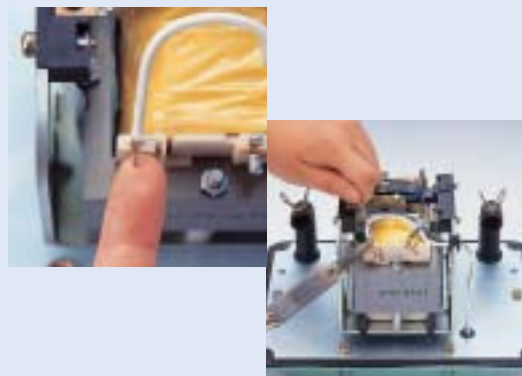

**STEP 7**

This completes the electromagnet replacement procedure.

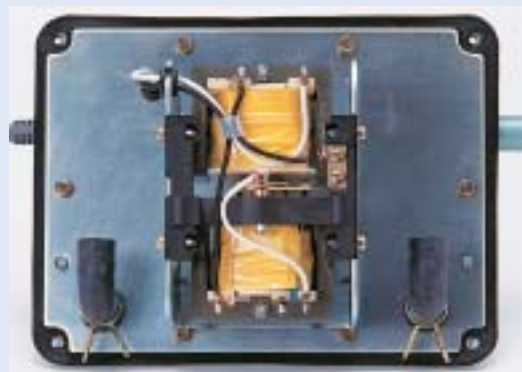



Air pump	Start of production	Discontinuance of production
HP-100	1997/10	—
HP-120	1997/10	—

## HP Series

## STRUCTURE AND PART NAMES

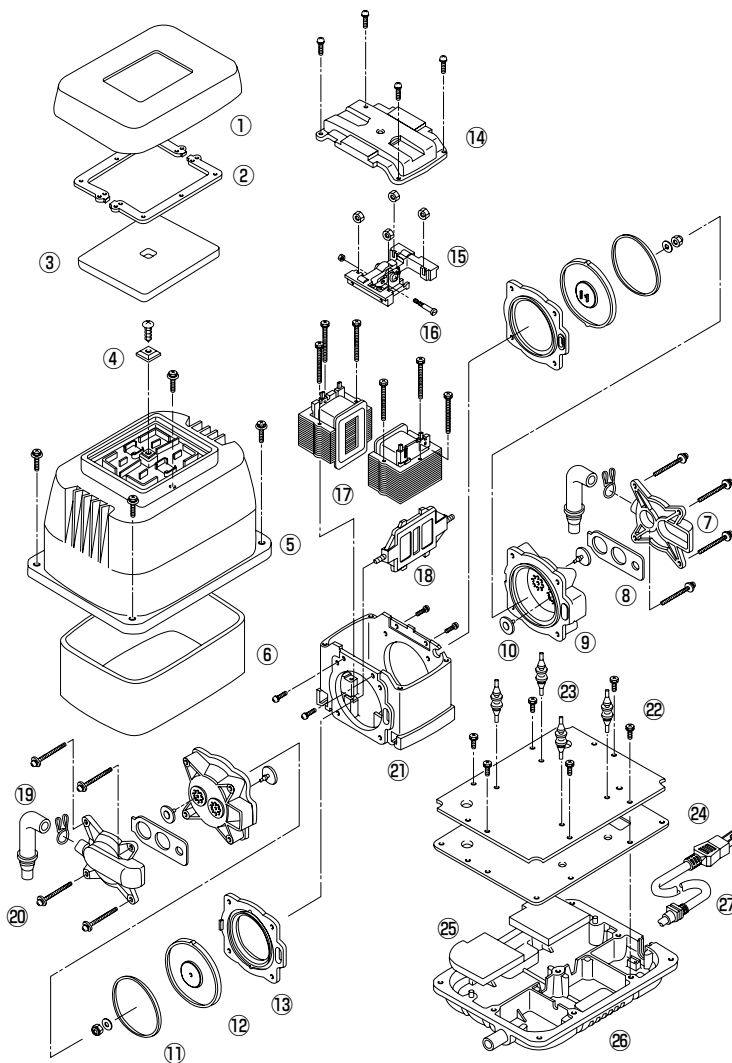

### HP-100/120

- ① Filter Cover
- ② Semi Cover Packing
- ③ Filter
- ④ Fitting Boss
- ⑤ Upper Housing
- ⑥ Sound Absorber (Lap)
- ⑦ Casing Block A
- ⑧ Valve Chamber Packing
- ⑨ Casing Block B
- ⑩ Valve
- ⑪ Diaphragm Ring
- ⑫ Diaphragm
- ⑬ Diaphragm Base
- ⑭ Frame Cover
- ⑮ SP Switch
- ⑯ Safety Screw
- ⑰ Electromagnet
- ⑱ Actuating Rod
- ⑲ L-Tube
- ⑳ Hose Band
- ㉑ Frame
- ㉒ Vibration Control Rubber
- ㉓ Center Plate
- ㉔ Gasket
- ㉕ Sound Absorber (Filter)
- ㉖ Lower Housing
- ㉗ Power Cord

**CAUTION**

- Be sure to unplug the pump unit.
- Replace the diaphragms and the valves with new ones at least once a year or one and a half years in order to maintain their initial performance.
- For chamber block replacement, be sure to change both chamber blocks at the same time.
- The rod employs powerful permanent magnets. Therefore, be sure to remove your watch and precision machine before starting the work as it may fail due to their strong magnetic force.
- Do not put the actuating rod close to a magnetic card, a magnetic disk or any other magnetic media as their data may be lost.

**STEP 1****REMOVAL OF THE CHAMBER BLOCKS**

Remove the upper housing.  
(See page18 “REMOVING UPPER HOUSING”)  
Remove the sound absorber.

**STEP 2**

Undo the frame screws and remove the frame cover.

**STEP 3**

Pull out the L-tube from the casing nozzle.



**STEP 4**

Remove the four screws hold the chamber block and the casing block on both side.  
(4screws on each side)

- *Casing block is separated into Casing A (Exhaust part side) and Casing B (Air valve side).*



**STEP 5**

Remove one of the U-lock nuts hold the diaphragm mounting block to the rod.

- *Use the box driver to loosen (or tighten) the U-lock nut.*



**STEP 6**

Remove one of the diaphragm mounting blocks from the actuating rod and pull out the other diaphragm mounting block with the rod and finally, separate the diaphragm mounting block and the rod.

- *When pulling out the rod, take care not to catch the rod projection on the lever of the SP switch.*
- *If the pump stops automatically, the safety screw must be broken to prevent any further damage to the pump. Be sure all debris is removed from unit. (See Step 15)*



**STEP 7**

**REPLACING THE DIAPHRAGM**

In case of replacing the diaphragm mounting block, skip some steps, and move straight from step 12.

Remove the diaphragm ring from the diaphragm, and then, the diaphragm from the diaphragm base.





**STEP 8**

Install a new diaphragm and a diaphragm ring in the diaphragm base.

- *Take care not to create any clearance between them.*



**STEP 9**

**REPLACING THE VALVE**

In case of replacing the diaphragm mounting block, skip some steps, and move straight from step 12.

Remove the valves from the casing B.

- *If it is difficult to separate them, insert the tip of a flatblade screwdriver into the clearance.*
- *Pull out the valves as they can be removed with facility.*



**STEP 10**

Insert each new valve into the center hole of valve seat, and secure them by pulling with the radio pliers.

- *When reinstalling the valves, make sure they are correctly fitted the exhaust and intake side.*



**STEP 11**

Cut away the respective pulling ends with scissors or nippers.

- *Leave each of the thick parts.*



**STEP 12**

**FITTING CHAMBER BLOCKS**

Set the actuating rod in line with groove and tighten U-lock nut with the box driver.

- Use new U-lock nut and washer only that come as replacement parts to prevent loosening and causing failure of the pump.



**STEP 13**

Insert the actuating rod in accordance with the gap of the frame.  
 Secure the diaphragm mounting block on the other side and tighten with washer and U-lock nut with the box driver.  
 Make sure the gaps between the actuating rod and the electromagnet are even.



**STEP 14**

Connect L-tube to the casing block and secure the casing with the screws.  
 (4screws on each side)  
 Install the other casing block at the same way.



**STEP 15**

**REPLACEMENT OF SAFETY SCREW**

Dispose of broken screw. Be sure all debris is removed from unit as it can result in damage to the permanent magnets and or even in a failure of the pump.



STEP  
16

Draw the new safety screw through a hole in the different direction of the terminal.  
(Threading order : The L-shaped lever-the spring electrode)



STEP  
17

Fasten screw with a nut.  
The screw is designed so that the nut will turn freely when it is properly fastened, stop tightening when this happens.



STEP  
18

This completes the replacement of the safety screw procedure.  
Make sure the gaps between L-shaped lever and lug of the actuating rod are even.

- *When checking the movement of the switch while the power is connected, touching the terminal will result in an electric shock.*
- *Unplug the pump immediately after the check.*



STEP  
19

Secure the frame cover with the screws.



**STEP  
20**

Install the sound absorber.

**STEP  
21**

Place the upper housing back on body.

- *Be extremely careful not to pinch the sound absorber in the upper housing.*

Secure it with the bolts.

Then, place the filter and filter cover on the upper housing. (See page17 “**FILTER CLEANING AND REPLACEMENT**”)



**CAUTION**

- Be sure to unplug the pump unit.
- When performing replacement work, the pump body may be still hot and you may get burnt. Therefore, wait until the pump has been allowed to cool.
- Be sure to remove the chamber block and the actuating rod before replacing the electromagnet.
- It is better to let an experienced technician handle the soldering process. Take precautions against being burnt.

**STEP 1****REMOVAL OF ELECTROMAGNET**

Cut the wire from the terminals on electromagnets with nippers.

- *It is recommended that you make a note of the wiring.*

**STEP 2**

Undo the frame screws and remove the SP switch.

**STEP 3**

Remove the nuts with the box driver.  
(8mm wrench)  
Pull out the electromagnets from the pump body.

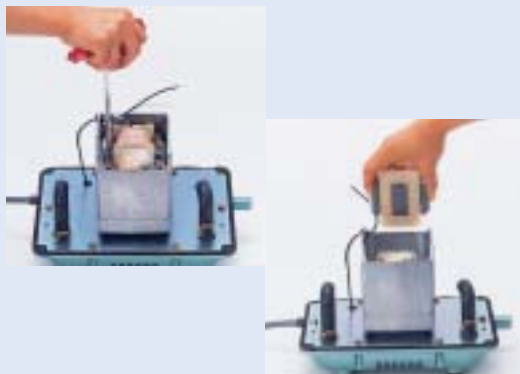

STEP 4

FITTING THE ELECTROMAGNET

Secure the electromagnets to the body by the nuts.  
Use the box driver. (wrench)

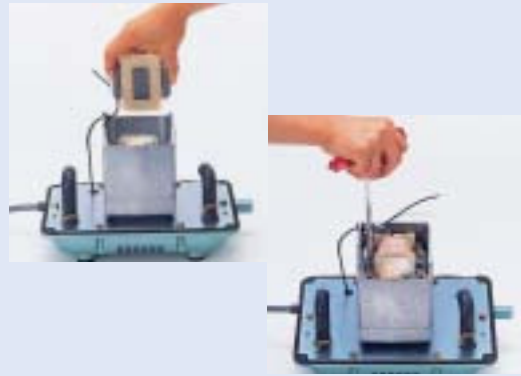

STEP 5

Secure the SP switch to the frame by the screws.

• *Be careful of the direction.*



STEP 6

Tie the wire in a bundle with a silicon tube.  
Strip off the coating each of the wire.  
(7mm from the end)  
Connect the wire to the terminals.  
Solder the wires to the terminals.  
The wire requires a soldered connection.







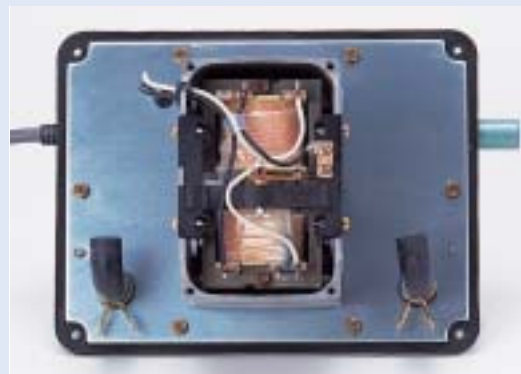

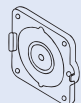
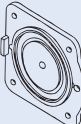

STEP 7

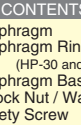
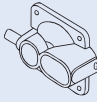
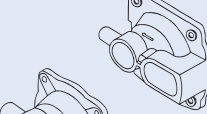
This completes the electromagnet replacement procedure.

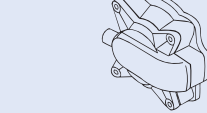

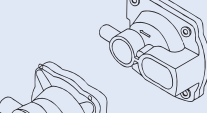

Parts Name	Models	Order Code
<b>Diaphragm Mounting Block [For HP]</b>    	HP-10 HP-20	10PD000010
	HP-30 HP-40	40PD000030
	HP-50	60PD000010
	HP-60 HP-80	80PD000040
	HP-100 HP-120	120PD20010
<b>CONTENTS</b> Diaphragm Diaphragm Ring (HP-30 and over) Diaphragm Base U-lock Nut / Washer Safety Screw (HP-60 and over) 2pcs./set		
<b>Casing Block [For HP]</b>    	HP-10 HP-20	10PK000010
	HP-30 HP-40	40PK000020
	HP-50	60PK000010
	HP-60 HP-80	80PK000040
	HP-100 HP-120	120PK20010
<b>CONTENTS</b> Casing Valve / Valve Chamber Packing Safety Screw (HP-60 and over) 2pcs./set		
<b>Chamber Block [For HP]</b>    	HP-10 HP-20	10PC000010
	HP-30 HP-40	40PC000030
	HP-50	60PC000010
	HP-60 HP-80	80PC000040
	HP-100 HP-120	120PC20010
<b>CONTENTS</b> Diaphragm Mounting Block Casing Block U-lock Nut / Washer Safety Screw (HP-60 and over) 2pcs./set		

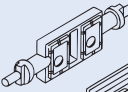
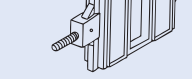
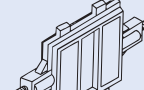
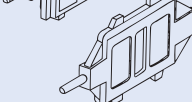
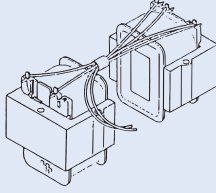
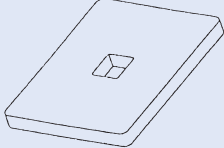
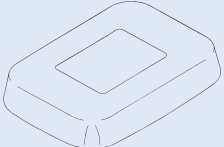
Parts Name	Models	Order Code
<b>Rod [For HP]</b>    	HP-10 HP-20	10PR000010
	HP-30 HP-40	40PR000030
	HP-50	60PR000010
	HP-60 HP-80	80PR000040
	HP-100 HP-120	120PR20010
<b>CONTENTS</b> Rod frame Magnet Center Screw (United) U-lock Nut / Washer (HP-60 and over) 1pcs./set		
<b>Electromagnet [For HP]</b> 	HP-10	PA01PEM100
	HP-20	PA02PEM100
	HP-30	PA03PEM101
	HP-40	PA04PEM100
	HP-50	PA05PEM100
	HP-60	PA06PEM100
	HP-80	PA08PEM100
	HP-100	PA10PEM100
	HP-120	PA12PEM100
	2pcs./set	
<b>Filter [For HP]</b> 	HP-10 HP-20	10PA000010
	HP-30 HP-40 HP-50	40PA000010
	HP-60 HP-80	80PA000040
	HP-100 HP-120	120PA20010
<b>Filter Cover [For HP]</b> 	HP-10 HP-20	10PA000C10
	HP-30 HP-40 HP-50	40PA000C10
	HP-60 HP-80	80PA000C40
	HP-100 HP-120	120PA20C10

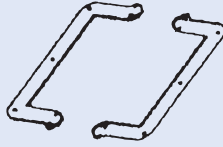
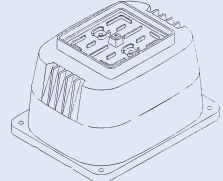
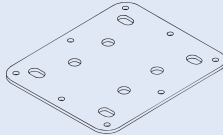
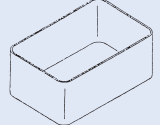
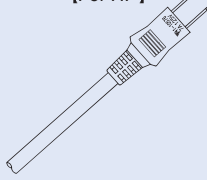
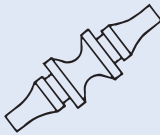

Parts Name	Models	Order Code
<b>Semi Cover Packing</b> [For HP] 	HP-10 HP-20	10PA00PK10
	HP-30 HP-40 HP-50	40PA00PK10
	HP-60 HP-80	FP00200101
	HP-100 HP-120	FP00200300
2pcs./set <b>Upper Housing</b> [For HP] 	HP-10 HP-20	10PH000U10
	HP-30 HP-40 HP-50	40PH000U10
	HP-60	60PH000U40
	HP-80	80PH000U40
	HP-100 HP-120	120PH20010
<b>Gasket</b> [For HP] 	HP-10 HP-20	10PN000010
	HP-30 HP-40 HP-50	40PN000010
	HP-60 HP-80	NP03000800
	HP-100 HP-120	120PN20010
<b>Sound Absorber</b> [For HP] 	HP-50	QN07500100
	HP-60 HP-80 HP-100 HP-120	QN08000200
<b>Power Cord</b> [For HP] 	HP-10 HP-20	PAEC00010P
	HP-30 HP-40 HP-50 HP-60 HP-80	PAEC00080P
	HP-100 HP-120	PA12PEM210
<b>Vibration Control Rubber</b> [For HP] 	HP-10 HP-20	10PF000D10
	HP-30 HP-40	10PF000D10
	HP-60 HP-80	80PF000D40
	HP-50 HP-100 HP-120	120PF20010
4pcs./set		

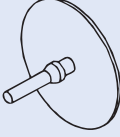
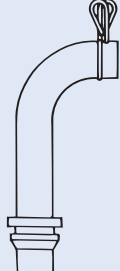
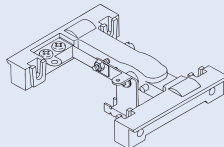
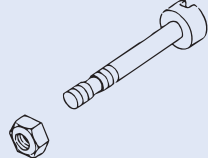
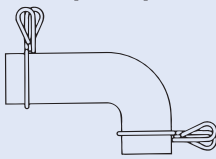
Parts Name	Models	Order Code
<b>Valve</b> [For HP] 	1Set	120VV20010
	5Set	120VV20020
	10Set	120VV20030
	25Set	120VV20040
4pcs./set <b>L-Tube</b> [For HP] 	HP-10 HP-20	PALK10
	HP-30 HP-40 HP-50	PALKGJL200
	HP-60 HP-80	PALK0L
	HP-100 HP-120	PALK1403
2pcs./set <b>SP Switch</b> [For HP] 	HP-60 HP-80	PASPSW
	HP-100 HP-120	PASPSW01
<b>Safety Screw</b> [For HP] 	HP-60 HP-80 HP-100 HP-120	PASPSW0100
<b>L-Shaped Hose</b> [For HP] 	All models except (150GJ-H / 200GJ-H)	PAJH0L

# TROUBLE SHOOTING

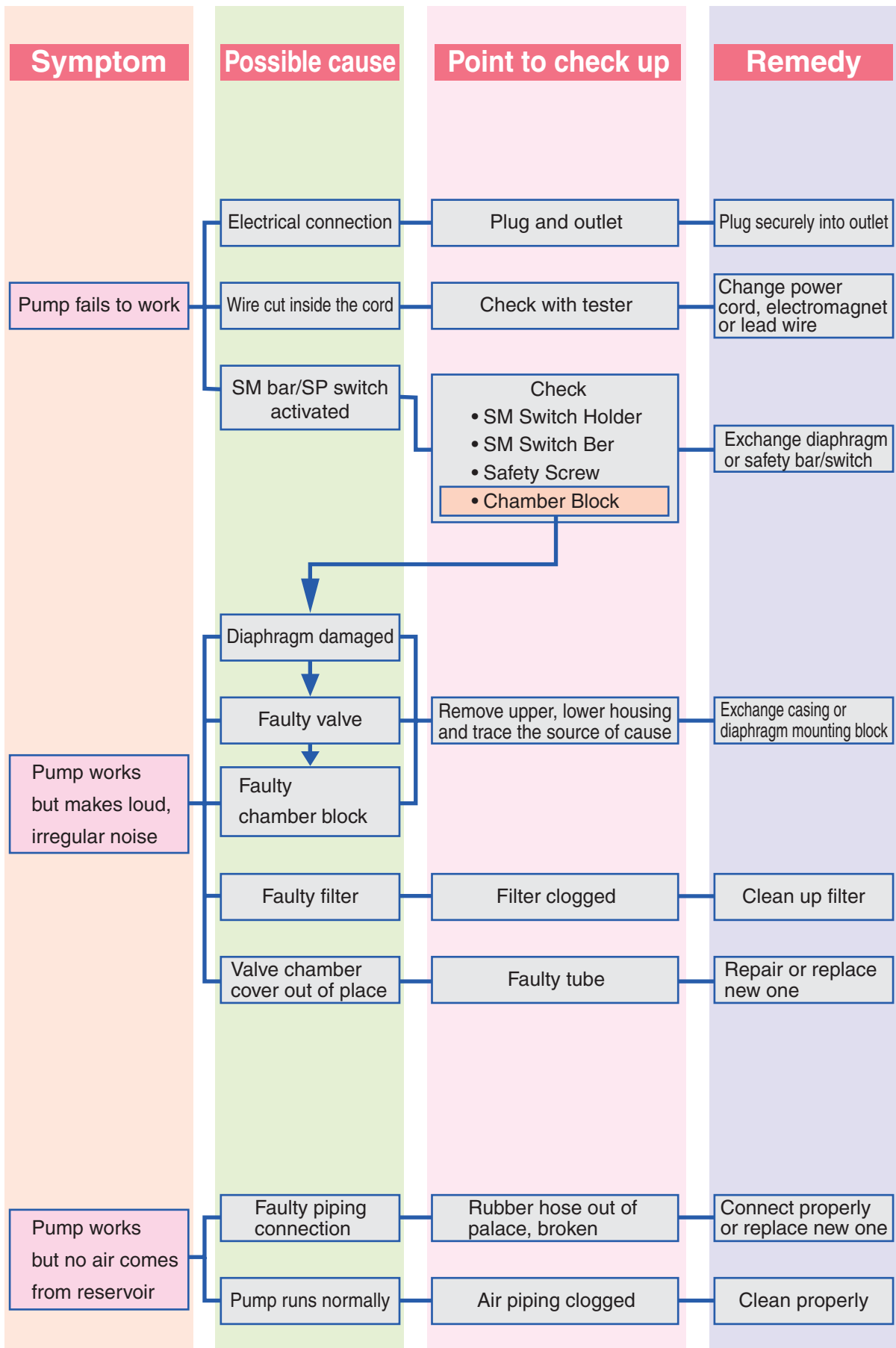





# HIBLOW

■ Distributor

■ Manufacturer



**TECHNO TAKATSUKI CO.,LTD.**  
<http://www.takatsuki.co.jp>

**Headquarters:** 8-16, Hatchonishimachi, Takatsuki, Osaka, 569-0095, JAPAN  
Telephone: 0726-84-0805 Fax: 0726-84-0807

**Tokyo Office:** 8F, Sunwood Machida Bldg., 4-15-13, Haramachida, Machida,  
Tokyo, 194-0013, JAPAN  
Telephone: 042-720-2882 Fax: 042-720-2883

00904.3000.M