

Dewenwils Outdoor Wi-Fi Smart Box

CAUTION! For outdoor use. For installation, rain-tight or wet location conduit hubs that comply with requirements of UL 514B Conduit, Tubing, and Cable Fittings must be used.
 Note: Installation should be made by a licensed electrician. Turn power OFF at the circuit breaker before installation.
READ ALL INSTRUCTIONS before using the ECO Smart Box.
Mac address: If your router identifies by Mac address, please key in the code number shown in the code label of the unit. i.e., 3x:2x:7x:0x:Cx:Cx
 Compatible with 2.4 GHz Wi-Fi networks.

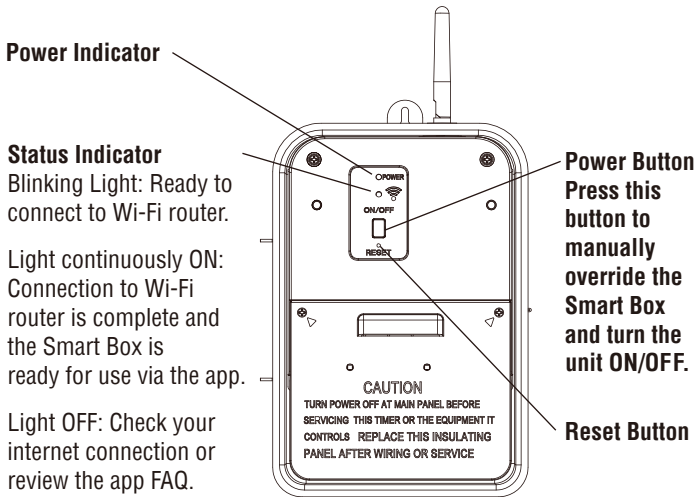

IMPORTANT: Please refer to INSTALLATION INSTRUCTION SHEET before proceeding with Wi-Fi router connection. Dewenwils Smart Box must be installed before connecting to Wi-Fi router.

TO CONNECT THE SMART BOX TO A WI-FI ROUTER

- With the Smart Box installed, if the blue light is blinking you can proceed to the next step to begin the smart phone setup. If not blinking, you must reset the Smart Box as described in the FAQ section on the reverse side of this sheet. Make sure the controlled device(s) are switched ON. Note: the blue light will continue blinking until the setup is finished via the smartphone app.
- Once you are finished connecting the Smart Box to a Wi-Fi router, the blue light will remain on continuously to indicate that Wi-Fi connection has been established and the Smart Box is accessible via the app.

DOWNLOAD THE ECO APP:

Download on the
App Store

(iOS 7 or higher)

ANDROID APP ON
Google play

(Version 4 or higher)

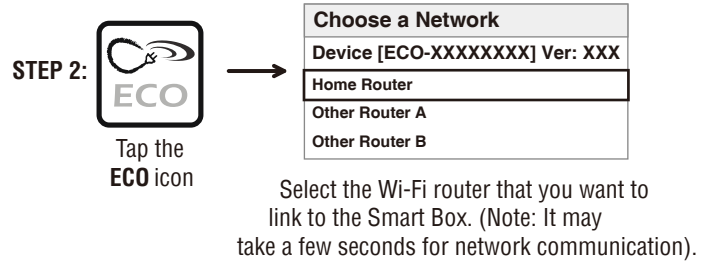
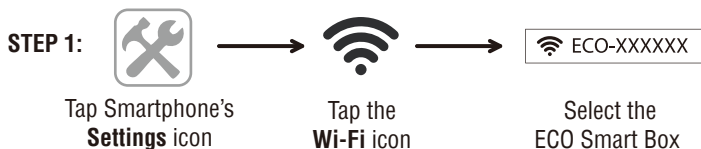

STEP 3: Fill in the information (Note: US residents enter your five-digit ZIP code, Canadian residents enter your three-digit telephone number area code). When finished filling in the information, click the **SAVE SETTINGS** or **JOIN** button. (In iOS: if you can't find the **JOIN** button, click in the "Password" box).

<input type="checkbox"/> USA	<input type="checkbox"/> Canada	<input type="checkbox"/> Other
Enter Zip Code: <input type="text"/>		
Name Device: (such as lamp or fan) <input type="text"/>		
Wi-Fi Router(WLAN):		
<input type="text" value="Home Router"/>		
Enter Wi-Fi Router Password: <input type="text"/>		
(Wi-Fi password, if needed)		

TO ADD ADDITIONAL SMART BOXES TO THE APP: Repeat steps 1-3 for each additional Smart Box. Remember to give each box a different name (for example, Master Bedroom, Home Office, etc.).
Note: Each Smart Box can be wired to control one or two circuits. To control more than two circuits, add additional Smart Boxes.

- More:** Learn more about this app, including an FAQ section.
- Usage:** Function is not available on this device.
- Settings:** To set your Wi-Fi Smart Box, transfer local Wi-Fi to cloud mode, or to rename the Smart Box.
- Timer:** To set ON/OFF programs (up to a maximum of 12 Custom ON/OFF events).
- Cloud Icon:** Activates remote access function of device through 3G, 4G, LTE, public Wi-Fi network, or other Wi-Fi router.
- Mailbox:** To email consumer service or share app feedback.
- Programmable Timer:** To set custom ON-OFF events.
- Countdown Timer:** The controlled device will turn off after selected time.
- Astronomic Timer:** The controlled device will turn on or off at sunset or sunrise.
- Vacation Random:** The controlled device will turn on or off randomly between one of three time frames (night, day, all day).
- Security Random:** The controlled device will turn on and off randomly between chosen start and end times.

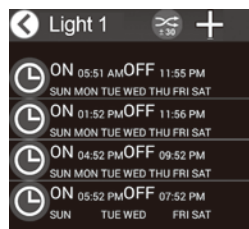

SELECTING WHICH DEVICE TO CONTROL: If you have multiple Smart Boxes connected to the app, you can choose which device you want to access (such as Master Bedroom, Home Office, etc.).

To select the device, slide the desired icon to the lower left position. The Smart Box name (such as "Master Bedroom," below), will change color from white to green. Chosen device is now able to be programmed or edited, such as changing timer settings, updating cloud service, etc.

Note: You can connect to a maximum of twelve (12) Smart Boxes via the app.

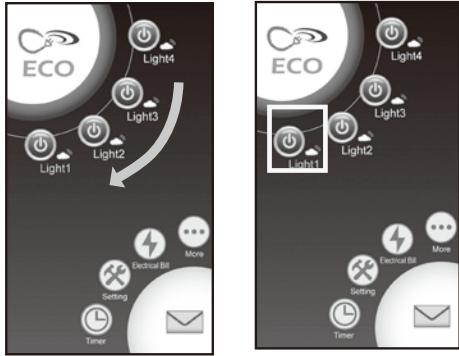

PROGRAMMING THE TIMER

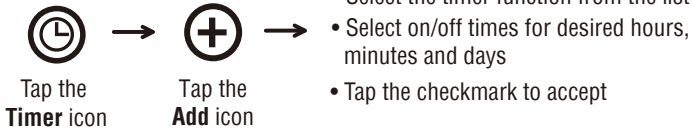

EDITING THE TIMER PROGRAM

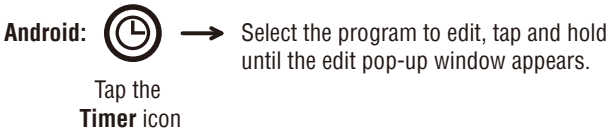
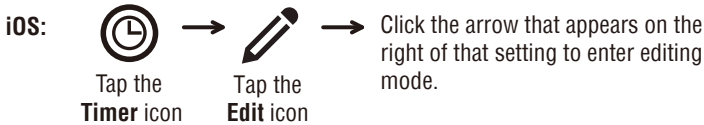

TO ACTIVATE CLOUD SERVICE

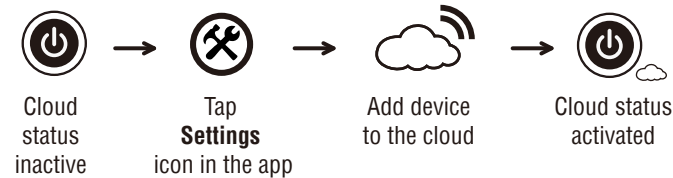

Note: To remove cloud service, follow the same steps and tap **Remove device from the cloud**.

TO ADD MULTIPLE USERS TO THE ECO OUTLET (Repeat steps below for each additional user):

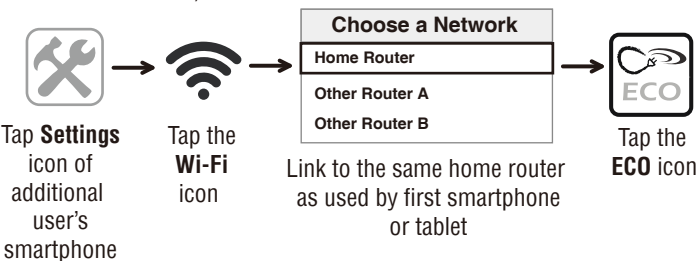

FREQUENTLY ASKED QUESTIONS



TO RESET THE SMART BOX: If you decide to connect this device to a new router, or are having trouble setting up this device after multiple attempts, try resetting the Smart Box.

- Press and hold the **Power** button while at the same time pressing the **Reset** button with the tip of a toothpick or similar non-conductive item. Continue holding the **Power** button for 3-5 seconds until the **Wi-Fi Status Indicator** light turns off.
- When the **Wi-Fi Status Indicator** light turns off, release the **Power** button and the Smart Box has been reset.
- After a few seconds the **Wi-Fi Status Indicator** light will begin blinking and the Smart Box is ready to be reconnected to the Wi-Fi router via the app.

This process removes any programmed settings, disconnects the app connection to the Wi-Fi router, and restores the Smart Box to the factory default setting.

FEDERAL COMMUNICATIONS COMMISSION INTERFERENCE STATEMENT INDUSTRY CANADA STATEMENT

This equipment has been tested and found to comply with the limits for a Class B digital device, pursuant to part 15 of the FCC Rules. These limits are designed to provide reasonable protection against harmful interference in a residential installation. This equipment generates, uses, and can radiate radio frequency energy, and if not installed and used in accordance with the instructions, may cause harmful interference to radio or television reception, which can be determined by turning the equipment on and off. The user is encouraged to try to correct the interference by one or more of the following measures:

- Reorient or relocate the receiving antenna
- Increase the separation between the equipment and the remote receiver.
- Connect the equipment into an outlet on a circuit different from that to which the receiver is connected
- Consult the dealer or an experienced radio/TV technician for help.

This device complies with Part 15 of the FCC Rules.

Industry Canada Statement: This Class B digital apparatus complies with Canadian ICES-003. This device complies with Industry Canada license exempt RSS standard(s). Operation is subject to the following two conditions: (1) This device may not cause interference, and (2) this device must accept any interference, including interference that may cause undesired operation of the device.

FCC Caution: Any changes or modifications not expressly approved by the party responsible for compliance could void the user's authority to operate this equipment.

FCC and IC Radiation Exposure Statement: This equipment complies with FCC and IC RSS-102 radiation exposure limits set forth for an uncontrolled environment. This equipment should be installed and operated with a minimum distance of 20cm between the radiator and your body.

Contains FCC ID: PAGEDCO-PLUG
Contains IC: 4494A-ECOPLUGS
CAN ICES-3(B)/NMB-3(B)

Apple is a registered trademark of Apple Inc.
Android is a registered trademark of Google Inc.
iOS is a trademark or registered trademark of Cisco in the U.S. and other countries and is used under license.
Wi-Fi™ is a trademark of Wi-Fi Alliance®



Dewenwils Outdoor Wi-Fi Smart Box INSTALLATION INSTRUCTIONS



WARNING: This timer should be installed by a licensed electrician. Turn power off at main panel before servicing this switch or the equipment it controls.

IMPORTANT: For outdoor use. Rain-tight or wet location conduit, hubs, tubing, and cable fittings that comply with requirements of UL 514B must be used for installation.

1. Read Important Safety Information below before beginning installation.
2. Open outer cover by releasing the spring latch.
3. Remove the interior protective cover by removing the two screws holding the cover in place (Figure 1).
4. Select the knockouts to be used. Remove the inner 1/2" knockout by inserting a screwdriver in the slot and carefully punching the knockout loose. Remove slug. If 3/4" knockout is required, also remove the outer ring with pliers after removing the 1/2" knockout. Smooth any rough edges with a file or sandpaper, if necessary.
5. Place the Smart Box in the desired mounting location and mark the location of the mounting keyhole. Install a screw at mark and drive partially in place. Attach Smart Box by placing keyhole over screw; then tighten screw firmly.
6. Wire in accordance with national and local codes (see wiring diagrams below). Use only copper conductors, #8 AWG wire, suitable for at least 175° F (80° C). Tighten all connections to 12in-lbf.
7. Grounding: Terminate all ground wires to grounding lug at the bottom of enclosure (Figure 2).
8. Replace interior protective cover.
9. Close outer cover. Smart Box is now ready to be connected to the WiFi router via the app.

Figure 1

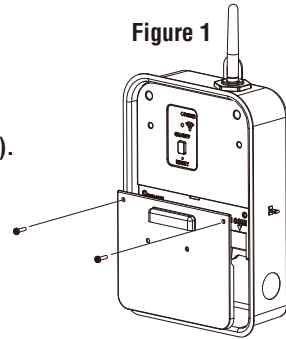
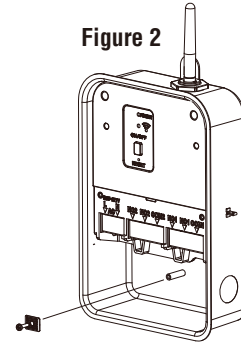

Figure 2



Important Safety Information

WARNING: Risk of Fire or Electric Shock. Read instructions thoroughly before installation and preserve for future reference.

Disconnect power at circuit breaker and test that power is off before installing (or servicing) the Smart Box (more than one circuit breaker or disconnect switch may be required to fully disconnect power).

Wiring must be in accordance with all national and local electrical code requirements. Inspect all terminals and wires with voltage meter before touching. The maximum total load to be controlled must not exceed Smart Box capacity.

The Smart Box enclosure does not provide grounding between conduit connectors. When metallic conduit is used, you must also install grounding type bushings and jumper wires in accordance with National Electrical Code (NEC) requirements.

Dewenwils Outdoor Wi-Fi Smart Box INSTALLATION INSTRUCTIONS

SMART BOX TERMINAL DESIGNATIONS

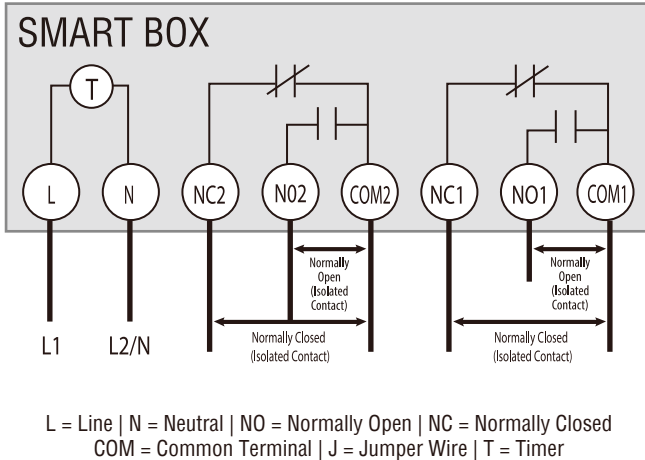

SMART BOX TYPICAL APPLICATION WIRING DIAGRAMS

Note: Smart Box is capable of being configured for 120VAC, 240VAC or 277VAC.

*J1 & J2 are 16 AWG jumper wire for the timer power supply.

120VAC Application Controlling One 120VAC Load

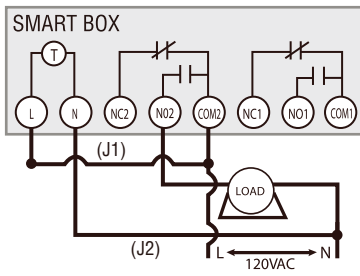

120VAC Application Controlling Two 120VAC Loads

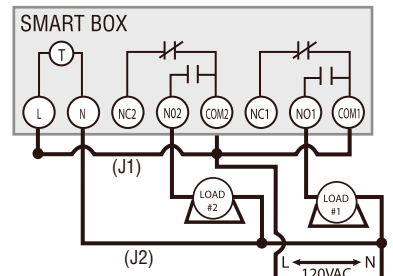

240VAC Application Controlling One 240VAC Load

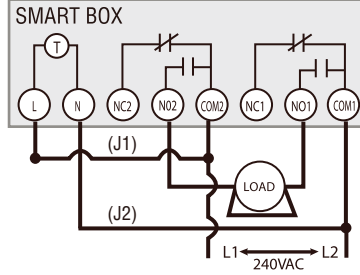

277VAC Application Controlling Two 277VAC Loads

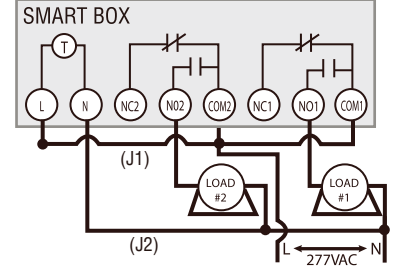

HOT WATER HEATER TYPICAL WIRING DIAGRAM

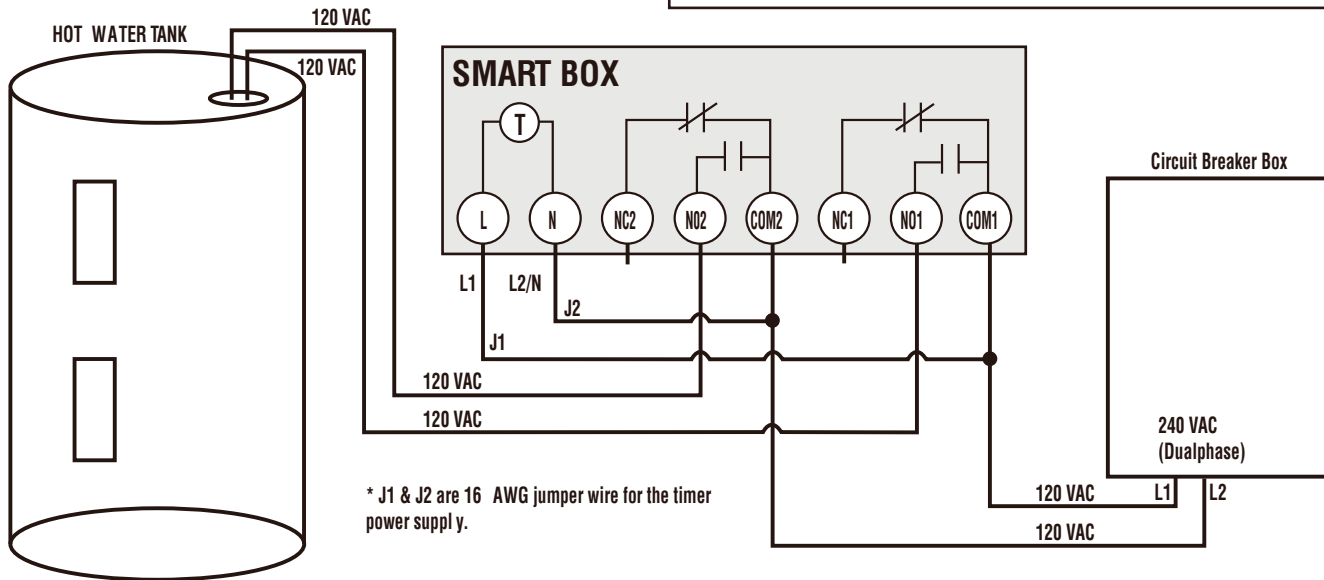

One-year Limited Warranty

Dewenwils warrants this product to be free from defects in material and workmanship for a period of one year from the date of purchase. Warranty will be void if damage is caused by misuse or improper installation. Please contact us if you have any questions.

Email: support@dewenwils.com.

Our dedicated customer service team will get back to you within 24 hours.