

PROTOCOL®

KAPTUR™

WI-FI DRONE WITH HD CAMERA

INSTRUCTION MANUAL



THANK YOU.

Thank you for your purchase of Protocol's **Kaptur Wi-Fi Drone with HD Camera**. You are about to experience the best of what remote control flight has to offer. We strongly recommend that you take the time to read this manual thoroughly. It contains many tips and instructions on how to get the most out of this aircraft and maintain it for a long life.

As with any aircraft, this is a precision flying machine. Treat it well and enjoy all the fun it has to offer, flight after flight.

TABLE OF CONTENTS

01	Safety & Precautions
02	Parts
04	Remote Battery, Blade Guard, & Phone Installation
05	Charging the Drone
06	Start-Up Procedure
07	Operation
09	Tips on 360° Flips
11	Speed Modes
12	Trim Adjustment
13	Troubleshooting
14	Flying Outdoors
15	Shooting Photo/Video
16	Replacement Parts & Limited Warranty

SAFETY WARNINGS

PRECAUTIONARY SAFETY WARNINGS

- Read and follow instructions on how to synchronize electronics before each flight.
- To prevent damage to people or property, always avoid contact with other objects while in flight.
- Focus on flight. Do not participate in other activities such as texting that would distract from flight.
- Do not fly under the influence of alcohol or drugs.
- Inspect aircraft prior to each flight and do not fly if damaged.
- Never expose product or any of its electronic parts to moisture, water, or heat sources.
- Charge device in a cool, dry place and under adult supervision. Never leave the device unattended while charging.
- To prevent overheating, allow battery a cool-down period before recharging.
- To prolong engine life, allow a cool-down period between flights.
- Use only the charger and/or charging cable that is supplied with this item.
- Do not strike, cut, or pierce the internal battery or subject it to hard impacts.
- Do not mix old and new batteries or mix different types of batteries.
- Never attempt to modify function of vehicle or controller or attempt repairs using parts other than those supplied by Protocol. Spare parts are available at www.protocolny.com.
- Do not travel or bring on an airplane with the battery over 5% charged.

**THIS DEVICE USES COMPONENTS THAT OPERATE AT HIGH SPEEDS.
AS WITH ANY SUCH DEVICE, USE CAUTION TO OPERATE SAFELY.**

**FAILURE TO FOLLOW ANY OF THESE GUIDELINES MAY RESULT IN
BODILY INJURY OR DAMAGE TO PERSONAL OR PUBLIC PROPERTY.**

WARNINGS

FAA FLIGHT REGULATIONS

- Observe local FAA rules and regulations for flight.
- Do not fly in unpermitted locations.
- Go to www.faa.gov/uas to learn more about FAA drone regulations.
- This drone weighs under .55lbs and does not require registration.

PARTS

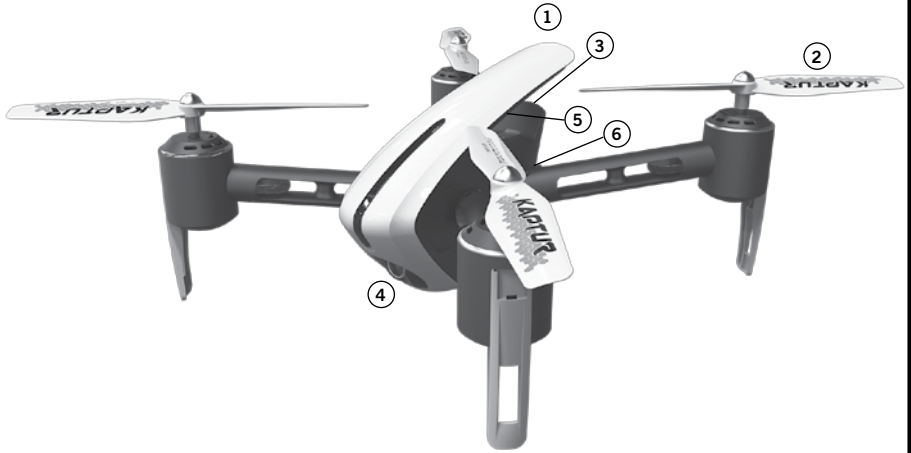

DRONE

1. Canopy
2. Blade
3. Battery Compartment
4. Camera
5. ON/OFF Switch
6. Memory Card Slot

ON/OFF SWITCH



BATTERY COMPARTMENT



PARTS

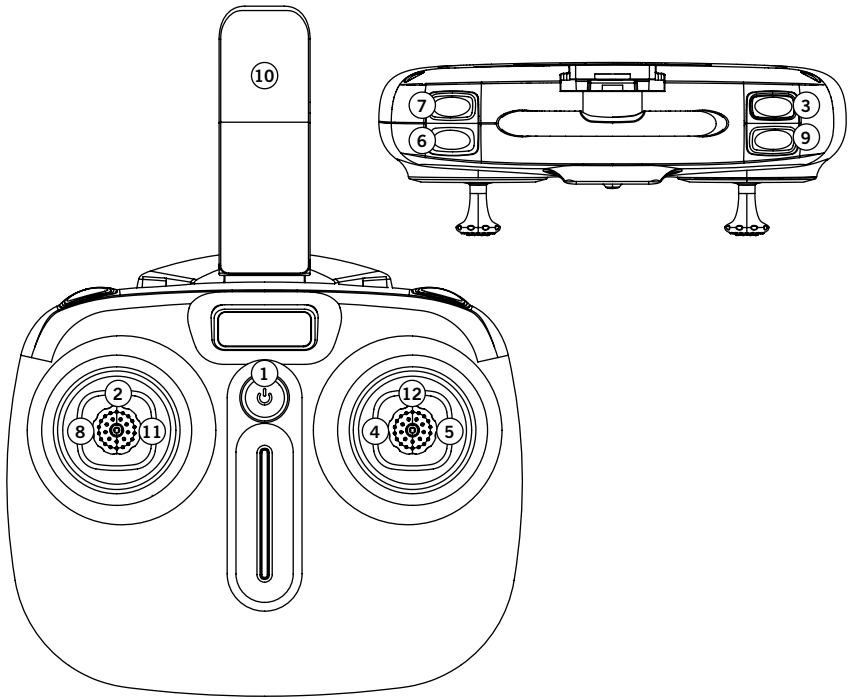

REMOTE

1. Power Switch
2. Trim (press in)
3. Flip 360°
4. Forward/Backward
5. Bank Left/Right
6. Video
7. Photo
8. Throttle
9. Auto Take Off/Land
10. Phone Clamp (not installed)
11. Turn Left/Right
12. Speed Mode Selector
(press in)

SPARE PARTS INCLUDED

- Replacement Blades
- Screwdriver

REMOTE BATTERY, BLADE GUARD & PHONE INSTALLATION

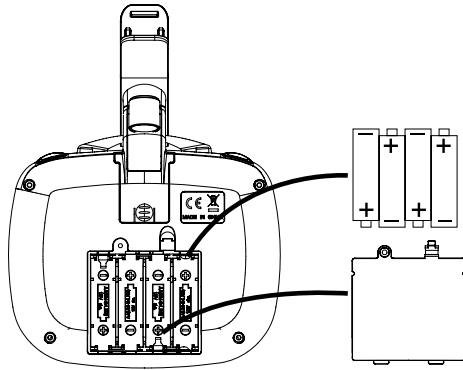

Unscrew and remove battery cover from controller. Insert 4 x 'AA' batteries according to indicated polarities. Replace and screw back in battery cover.

1. Install batteries carefully.
2. Do not mix old and new batteries.
3. Do not mix different types of batteries.

INSTALLING THE BLADE GUARD

If not already installed, install the included blade guards by snapping them in. Make sure the blade guards are secure and snug.

NOTE:

Loose blade guards may interfere with propeller movement and cause a crash. If the drone crashes, double check to make sure the blade guard is not loose. If it is, re-tighten before flying.

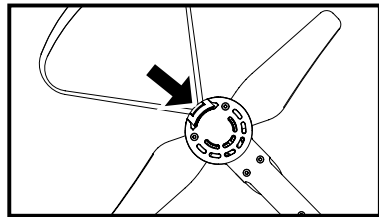

INSTALLING THE PHONE CLAMP

1. Remove the clip cover from the remote control.
2. Insert the phone clamp into the now empty slot on the remote.
3. Open the clamp to fit the phone.

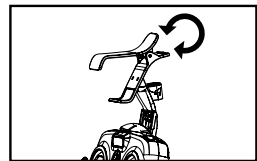
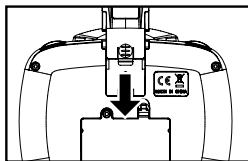
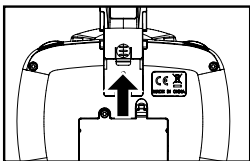

CHARGING THE DRONE BATTERY

1. Make sure the drone is turned off.
2. Press in on the two tabs and pull out the cartridge battery from the drone.
3. Connect the USB charging cable to the battery.
4. Plug the charger into a USB port. The USB light will flash green while charging and will turn steady once fully charged.
5. Plug the battery back into the drone.
Charging time: 140 minutes --- Flying time: approximately 12 minutes.

DO NOT CHARGE OVERNIGHT OR BEYOND THE CHARGING TIME STATED. DO NOT LEAVE BATTERY UNATTENDED.

*Battery: Li-Po, 7.4V, 700mAh

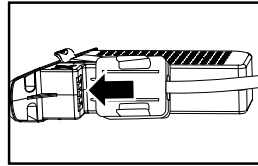

BATTERY SIGNALS

Lights are steady	Power is over 20% - will perform flips
Lights quickly flash twice every second	Power is under 20% - approximately 2 minutes left of flight time. Drone will no longer perform flips.

If you purchased extra batteries, allow the engines to cool between flights in order to prolong engine life.

CAUTION WHEN CHARGING

1. When charging, place product on a dry, well-ventilated surface and keep away from heat sources.
2. Always use adult supervision while charging.
3. In order to increase battery longevity, avoid repeat charging and excessive discharging.
4. As battery temperature is high immediately after flight, charge after cooling down for higher efficiency.
5. Do not strike or subject battery to hard impacts or sharp surfaces.
6. Do not use any other charger than that which is supplied with this item.
7. Do not use or leave battery near a heat source such as fire or space heater; exposure to heat may result in reduced performance or in some cases dangerous conditions.
8. If battery is left in charging state for an extended period of time after being fully charged, the battery may automatically discharge.
9. Never leave the battery unattended during charging.
10. Do not disassemble battery.
11. Do not submerge battery in water.

START-UP PROCEDURE

Before flying, the drone and transmitter must be turned on in sequence and synchronized.

1. Turn on the drone and place it on an even surface. The white lights on the drone are at the front and the red are at the back.
2. Turn on the remote control.
3. Both indicators on the drone and the remote will flash while they are syncing.
4. Push the throttle up and then down to sync. You will hear two beeps and the lights will go steady.

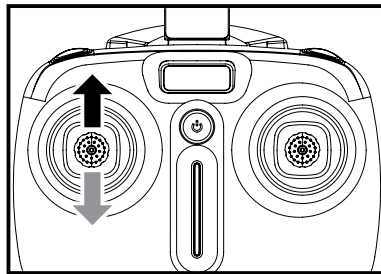

NOTE:

1. While the drone is in process of synchronizing, the lights will flash quickly. When the process is completed, the lights will go steady. This is your indication that the process is completed.
2. If after 30 seconds, it has not recognized the drone, turn off the controller and repeat Start-Up procedure.
3. If the Kaptur is unsteady in flight, it may not have been able to calibrate properly. Power down both drone and remote and restart pre-flight procedure, including re-calibration of the altitude sensor.

OPERATION: FLYING THE DRONE

*The lights on the drone may flash occasionally while the optical position sensor automatically locks into place. Once it is locked, the lights will remain steady while it has over 20% battery power.

STARTING THE ENGINE:

After synchronizing the drone, move the throttle up and release to go into Idle mode. The blades will rotate but the drone will not lift.

OR

After synchronizing the drone, pull the throttle and direction stick to the center at the same time and release. The blades will rotate but the drone will not lift.

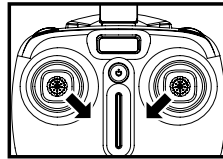
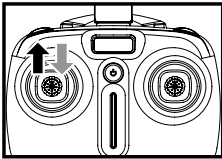

TAKE-OFF:

1. Press the take off button. The remote will beep and the drone will hover a few feet off the ground. Then gently advance the throttle to a desired height and release. The drone will hover at that height.*

OR

2. From Idle mode, gently advance the throttle up to a desired height and release. The drone will hover at that height.*

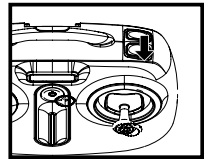

LANDING:

1. Press the landing button to lower the drone to the ground.

OR

2. Push down on the throttle until the drone is on the ground.

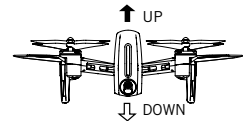
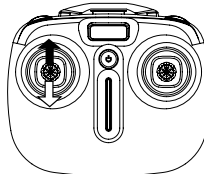

NOTE:

- The engine will shut off if you choose to hold the throttle down for 3 seconds.

- **Emergency Shut Off: When in flight, pull the throttle and direction stick to the center at the same time and the drone will shut off. Emergency Shut Off only works at altitudes under 10 feet.**

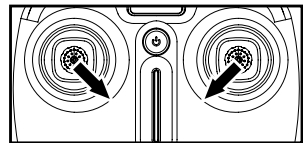

* The drone may drift a bit, especially in the first 30 seconds until the altitude sensor gets a good fix on the position. Some drift is normal.

OPERATION: FLYING THE DRONE

FIRST TIME FLYERS!!! TAKE YOUR TIME! GO SLOW!

Practice hovering until you are comfortable with flight before attempting any other maneuvers. Make small movements letting the stick return to the center. If you start to lose control, don't panic. Just press land.

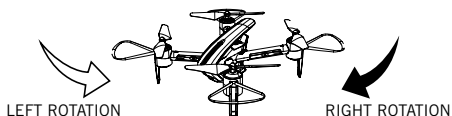
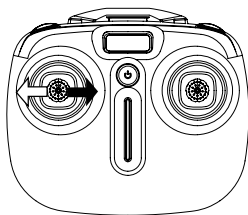

Pull the throttle left or right,
the drone turns to the left or right.

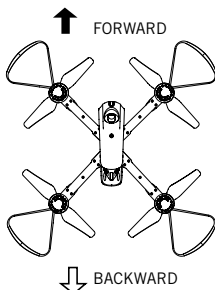
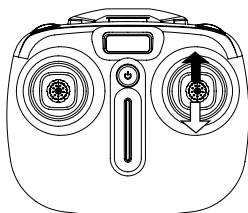

Push the direction lever up or down,
the drone flies forward or backward.

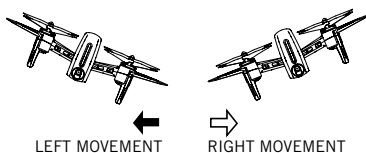
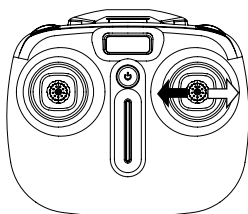

Pull the direction lever to the left or right,
the drone banks to the left or right.

TIPS ON 360° FLIPS

Once you have become skilled with the basics of drone flight, you can try some advanced maneuvers. At a height of at least 10 feet, press and hold the 360° Flip button and move the direction lever in any desired direction to execute the flip.

*Make sure to execute the flip outdoors in a space that's free of obstacles.

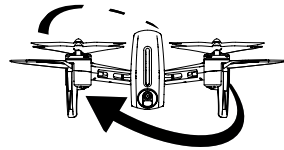
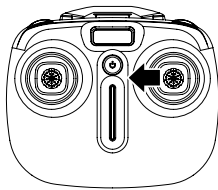
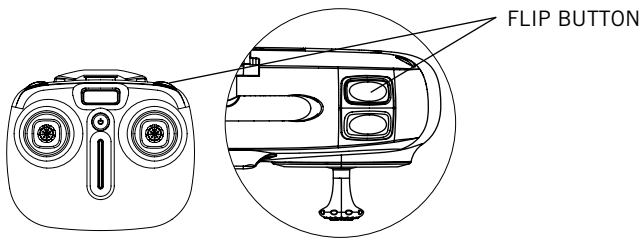

LEFT 360° FLIP

Push the direction stick to the left and the drone will perform a 360° flip in that direction.

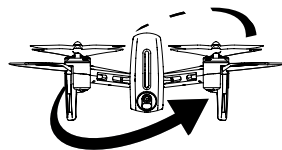
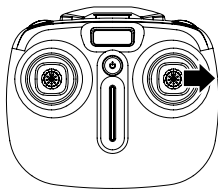

RIGHT 360° FLIP

Push the direction stick to the right and the drone will perform a 360° flip in that direction.

TIPS ON 360° FLIPS

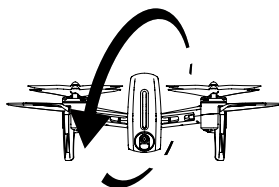
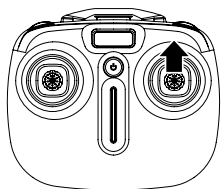

FORWARD 360° FLIP

Push the direction stick forward and the drone will perform a 360° flip in that direction.

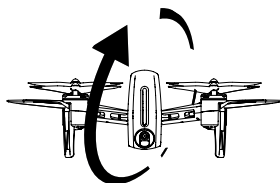
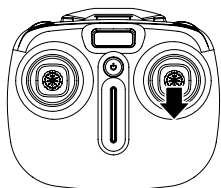

BACKWARD 360° FLIP

Push the direction stick backward and the drone will perform a 360° flip in that direction.

SPEED MODES

The Kaptur features two speed modes. Choose the speed based on flight experience and level of comfort. At high speed the drone will pitch more than at low speed. Kaptur is quite fast at its high speed and requires more piloting skills to fly competently. For safety take time to develop advanced skills by practicing at low speed first. The drone is preset to low speed. Press the direction stick in to change the speed mode. The remote will beep once for low speed and twice for high speed.

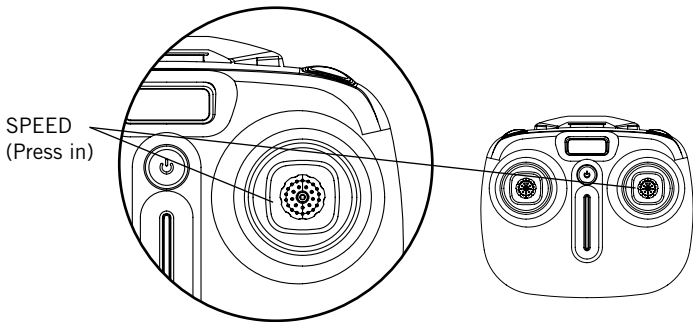

TRIM ADJUSTMENT

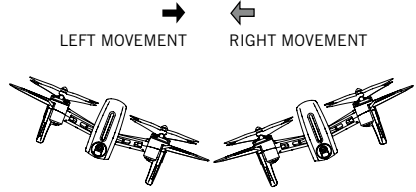
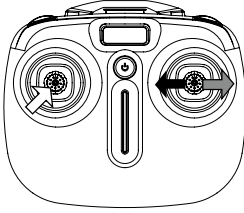

SIDWAYS TRIM

When the drone drifts to the left or right side unintentionally, you can correct it by pressing in the throttle and holding while moving the direction stick in the opposite direction until it evens out.

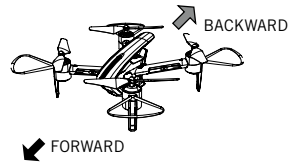
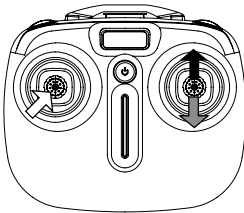

FORWARD/BACKWARD TRIM

When the drone drifts forward/backward unintentionally, you can correct it by pressing in the throttle and holding while moving the direction stick in the opposite direction until it evens out.

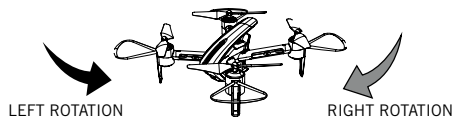
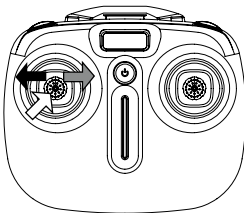

LEFT/RIGHT TRIM

When the drone drifts left/right unintentionally, you can correct it by pressing in the throttle and holding while moving it in the opposite direction until it evens out.

*NOTE: Trim adjustments are designed to counter drifts not caused by wind.

TROUBLESHOOTING

RE-CALIBRATING THE DRONE

If the drone crashes and after re-starting and trimming, it still is unstable, you have the option to re-calibrate the drone.

1. Turn on the drone and then the remote and sync.
2. Push and hold the both the throttle and direction stick to the lower right corners for 2-3 seconds.
3. The lights will flash to indicate that the drone has re-calibrated.

*Allow 15 minutes to pass between full flights as this will give the motors a chance to cool down. Failure to do so could wear out and shorten the life of the motors.

SYMPTOM	POSSIBLE CAUSE	POTENTIAL SOLUTION
Kaptur does not respond	<ol style="list-style-type: none"> 1. Communication between controller and aircraft was not synchronized during set up 2. Battery power depleted on aircraft, controller or both. 	<ol style="list-style-type: none"> 1. To synchronize, turn on aircraft first, place it on level ground, and then turn on controller. 2. Charge aircraft and/or replace batteries in controller.
Response to control inputs intermittent or erratic	<ol style="list-style-type: none"> 1. Controller battery power nearly depleted. 	<ol style="list-style-type: none"> 1. Replace batteries in controller.
Kaptur will not hover or strafe correctly	<ol style="list-style-type: none"> 1. The aircraft was not on level ground during synchronization. 2. Trim settings are incorrect. 	<ol style="list-style-type: none"> 1. Re-synchronize aircraft and controller. 2. Recalibrate the Altitude Sensor.

HOW TO CHANGE THE BLADES

- All drones have two rotors that spin clockwise and two rotors that spin counter-clockwise.
- Make sure to place the blades on the correct axis or they will not spin correctly and the drone will not lift.
- Each blade is marked on its top with A or B. There may be a number after the letter but you can ignore the number.
- Make sure to follow the graphic below to see where to place the blades.

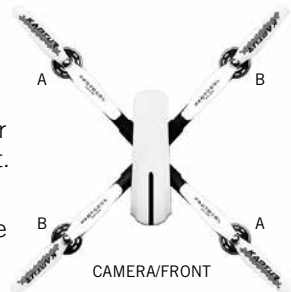

FLYING OUTDOORS

HOW TO PREVENT FLY AWAYS

To prevent “fly-away” situations (where drones seem to fly away out of control) it is important to first test and practice within close range before letting the drone fly too far away.

Each drone is designed to turn off the engines if the radio signal is lost. It is important to know and test the range of your drone before flying. We recommend turning on and syncing the drone and walking away while testing the engines. Keep walking and testing until it is obvious when you reach the point where the signal is not controlling the drone. This will be the control limit for the conditions in which you are flying. Distance does vary somewhat based on environmental and weather conditions, so testing the limit is advised. Fly in a range that is good for easy visual operation of the drone.

IF YOU CAN'T SEE YOUR DRONE, THEN YOU CAN'T CONTROL YOUR DRONE.

* Fly-aways are not covered by warranty as they are overwhelmingly caused by pilot error.

SHOOTING PHOTO/VIDEO

1. The memory card comes pre-inserted into the camera.
2. Set the camera in a desired position by pushing it up or down. Touch only the outer rim of the camera. Do not touch the lens.

SHOOTING PHOTOS AND VIDEO

1. Turn on the drone and sync.
2. Photo: Push the Photo button and the camera will take a photo. The lights on the drone will flash once as it's taking the picture.
3. Video: Push the Video and the camera will begin to record. The lights on the drone will flash continuously while recording. Push the Video button again and the camera will stop recording.
4. Press the memory card to unlock and remove. Plug it into the USB card reader. Then plug the card reader into the USB port of your computer. If you are using Windows, the USB will come up on the removable drive. If you are using OS, then the USB will come up as "Untitled".
5. Open the drive and then open the Video or Photo folders to access the .AVI or JPEG files.
6. .AVI movies can be played in several different formats including Quicktime, Windows Media Player, and RealPlayer.

WARNING: Never remove the card from the video camera while the drone is turned on.

REPLACEMENT PARTS

Thank you for your purchase of Protocol's **Kaptur Wi-Fi Drone with HD Camera**. We know that accidents can sometimes happen and that is why we offer spare parts kits on our website: **www.ProtocolNY.com**.

LIMITED WARRANTY

At Protocol, we're dedicated to bringing you innovative and well-designed products that make living fun and easy. We stand behind all of our products and warrant this to be free from defects in workmanship and materials for 30 days from the date of purchase. The warranty does not cover transportation damage, misuse, accident, or similar events. Specific legal rights pertaining to this warranty may vary by state.

For service claims or questions please consult our website **www.ProtocolNY.com**.

Wi-Fi AND APP INSTRUCTIONS FOR KAPTUR WI-FI DRONE WITH HD CAMERA

Age
14+



*Please check our website ProtocolNY.com for updates and instructions to our Apps.

Wi-Fi range is approximately 130 feet. If you plan to fly out of this range make sure to hit record from the remote.

Phone Mount

1. Install the phone mount and phone to the remote.

Install the App:

1. The App is available in both Apple and Android APP stores. Search "Protocol Kaptur" and download the App to your smartphone.

Shooting Video/Photo

1. Turn on the Kaptur and the remote control.
2. Once it is turned on, the Kaptur will transmit a Wi-Fi signal, "Kaptur". Make sure your smartphone is connected to that signal.
3. Open the app and press "START →" (Fig. 1).
4. The screen will show and live stream the camera view.
5. To film video, hit the video icon once. To stop filming, hit the icon again (Fig. 2)
6. To snap pictures, press the photo icon once.

*More than one device can live stream and record from the drone. The first device to connect to the Wi-Fi signal is the control and the video that device records will save to the SD card as well as the app. The second device can record video to the app but it will not save to the SD card.

Shooting in VR

1. Insert the phone in a VR viewer.
2. Press the VR icon (Fig. 3). The phone will shoot and live stream in VR mode.
3. Press the VR icon again to leave VR mode.

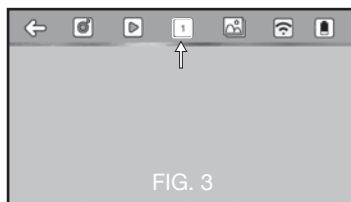
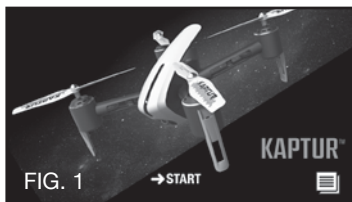

Viewing and Saving Recorded Video/Photo

To see recorded video and images, press the picture icon. There are three subfolders, one for photo, one for video, and one for SD card (Fig. 4).

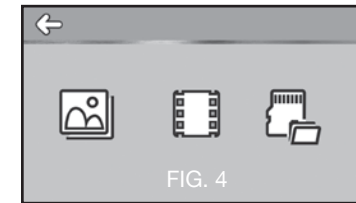

Apple/Android:

1. To download photos and video to your phone, hit select and pick the content you want to save. Then hit the download icon to save to the phone.

Video folder: Video recorded in this folder can playback recorded sound. Videos in this folder are recorded through the app.

SD Card Folder: Video recorded in this folder will not playback recorded sound. Furthermore, the recorded sound will not record onto the physical SD card. Videos in this folder are either recorded through the app or through the remote.

2. All videos can be viewed in VR mode through the App. Press the VR button when viewing the video. You cannot view VR video through the phone's photo album.

Deleting Content from the App:

Apple:

Select the images or video you want to delete. Press the "Delete" button.

Android:

Open the image or video, and then select the trashcan icon to delete.



Icon Key

1. Return to previous menu
2. Take photo
3. Record video
4. VR Mode (active or inactive)
5. View photos and video
6. Wi-Fi Signal
7. Battery