

PROTOCOL®

DURA HD™

DRONE WITH LIVE STREAMING CAMERA

INSTRUCTION MANUAL



THANK YOU.

Thank you for your purchase of Protocol's **Dura HD Drone with Live Streaming Camera**. You are about to experience the best of what remote control flight has to offer. We strongly recommend that you take the time to read this manual thoroughly. It contains many tips and instructions on how to get the most out of this aircraft and maintain it for a long life.

As with any aircraft, this is a precision flying machine. Treat it well and enjoy all the fun it has to offer, flight after flight.

TABLE OF CONTENTS

01	Safety & Precautions
02	Parts
04	Remote Battery & Phone Installation
05	Charging the Drone
06	Start-Up Procedure
08	Operation
10	Speed Modes
11	Trim Adjustment
12	Troubleshooting
14	Flying Outdoors
15	Replacement Parts & Limited Warranty

SAFETY WARNINGS

HAVE FUN, BUT SAFETY FIRST!

- Read and follow instructions on how to synchronize electronics before each flight.
- To prevent damage to people or property, always avoid contact with other objects while in flight.
- Inspect aircraft prior to each flight and do not fly if damaged.
- Never expose product or any of its electronic parts to moisture, water, or heat sources.
- To prevent overheating, allow battery a cool-down period before recharging.
- To prolong engine life, allow a cool-down period between flights.
- Use only the charger and/or charging cable that is supplied with this item.
- Do not strike, cut, or pierce the internal battery or subject it to hard impacts.
- Do not mix old and new batteries or mix different types of batteries.
- Never attempt to modify function of vehicle or controller or attempt repairs using parts other than those supplied by Protocol. Spare parts are available at www.ProtocolNY.com

**THIS DEVICE USES COMPONENTS THAT OPERATE AT HIGH SPEEDS.
AS WITH ANY SUCH DEVICE, USE CAUTION TO OPERATE SAFELY.**

**FAILURE TO FOLLOW ANY OF THESE GUIDELINES MAY RESULT IN BODILY
INJURY OR DAMAGE TO PERSONAL OR PUBLIC PROPERTY.**

PARTS

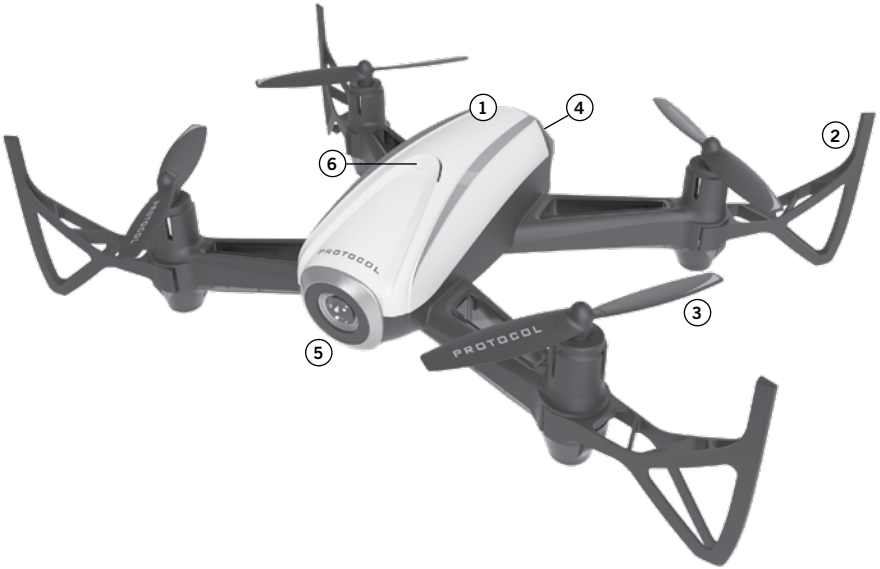

DRONE

1. Canopy
2. Blade Guard
3. Blade
4. Battery Compartment
5. Camera
6. Power Button (hold for 3 seconds when turning on and off)

PARTS

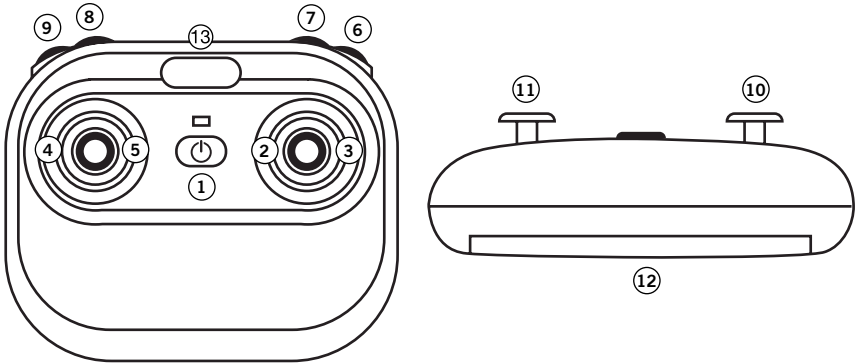

REMOTE

1. Power Switch
2. Forward/Backward
3. Bank Left/Right
4. Throttle
5. Turn Left/Right
6. Take Off/Landing
7. Compass Mode
8. Photo
9. Video
10. Speed Mode Selector
11. Trimmer
12. Battery Cover
13. Phone Mount Slot

SPARE PARTS INCLUDED

- Replacement Blades
- Screwdriver

REMOTE BATTERY AND BLADE GUARD INSTALLATION

INSTALLING THE BATTERIES

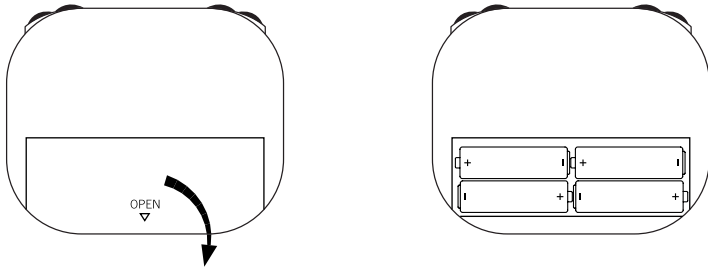

Remove battery cover from controller. Insert 4 x 'AA' batteries according to indicated polarities. Replace battery cover.

1. Install batteries carefully.
2. Do not mix old and new batteries.
3. Do not mix different types of batteries.

INSTALLING THE PHONE

1. Insert the base of the mount into the slot until it clicks.
2. Pull the clamp open and insert the phone.
3. To remove, squeeze and push out.

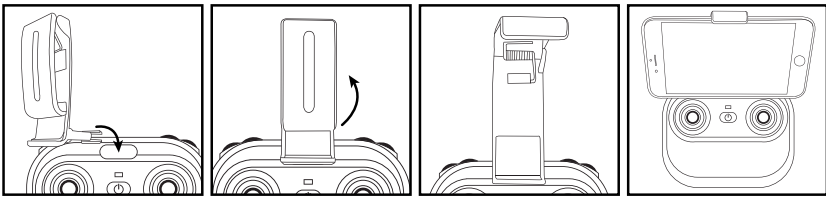

CHARGING THE DRONE BATTERY

1. Make sure the drone is turned off.
2. Pull out the cartridge battery from the drone.
3. Connect the USB charging cable to the battery.
4. Plug the charger into a USB port. The USB light will stay red while charging and will turn green once fully charged.
5. Plug the battery back into the drone.

Charging time: 60 minutes --- Flying time: approximately 6 minutes

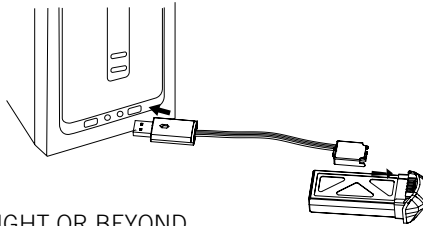

DO NOT CHARGE OVERNIGHT OR BEYOND THE CHARGING TIME STATED. DO NOT LEAVE BATTERY UNATTENDED.

*Battery: Li-Po, 7.4V, 350mAh

If you purchased extra batteries, allow the engines to cool between flights in order to prolong engine life.

CAUTION WHEN CHARGING

1. When charging, place product on a dry, well-ventilated surface and keep away from heat sources.
2. Always use adult supervision while charging.
3. In order to increase battery longevity, avoid repeat charging and excessive discharging.
4. As battery temperature is high immediately after flight, charge after cooling down for higher efficiency.
5. Do not strike or subject battery to hard impacts or sharp surfaces.
6. Do not use any other charger than that which is supplied with this item.
7. Do not use or leave battery near a heat source such as fire or space heater; exposure to heat may result in reduced performance or in some cases dangerous conditions.
8. If battery is left in charging state for an extended period of time after being fully charged, the battery may automatically discharge.
9. Never leave the battery unattended during charging.
10. Do not disassemble battery.
11. Do not submerge battery in water.

START-UP PROCEDURE

Before flying, the drone and transmitter must be turned on in sequence and synchronized.

1. Turn on the drone by pressing the on button and holding for 3 seconds. The lights on both sides of the drone will flash to indicate it's on. Place it on an even surface. The blue lights on the drone are at the front and the yellow are at the back.
2. Turn on the remote control.
3. Push the throttle down and then release. The remote will beep two times and the flashing lights on the drone and remote will turn steady to indicate it has synced.
4. Your drone is now synchronized, and in stand-by mode awaiting Engine Idle command.

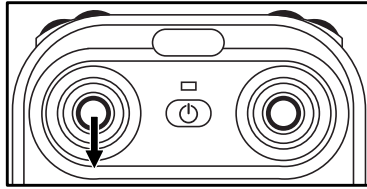

NOTE:

1. If after 30 seconds, it has not recognized the drone, turn off the controller and repeat Start-Up procedure.

STARTING THE ENGINE; ENGINE IDLE

After synchronizing the drone, move the throttle and direction sticks in to the lower center corners (silver lines) and release to go into Idle mode. The blades will rotate but the drone will not lift.

START-UP PROCEDURE

COMPASS MODE

Users have the option to exit the default orientation (blue lights at the front, yellow lights at the back). In Compass Mode, users can operate the drone without orientation. Regardless of where the drone is pointing, it will turn left or right according to the remote's command.

Compass Mode is good for beginners and is useful for drones that fly too far away for the user to be able to tell the orientation.

Follow the below instructions to change to Compass Mode:

- 1) It is easiest to set up Compass Mode before flight. Sync and turn on the engines.
- 2) Make sure your drone is aligned with the remote as indicated in the picture.
- 3) Press down on the Compass Mode button once. The drone's left and right LEDs will start to alternately flash. This indicates that the drone is now in Compass Mode.
- 4) Press the Compass Mode button again to leave Compass Mode.

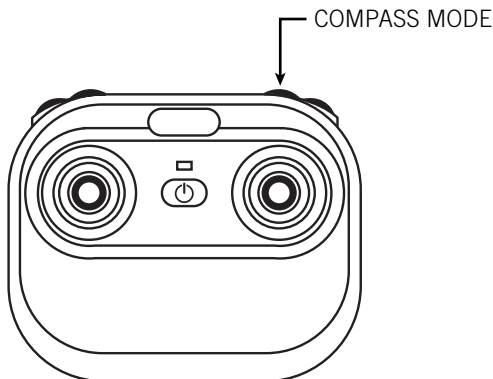
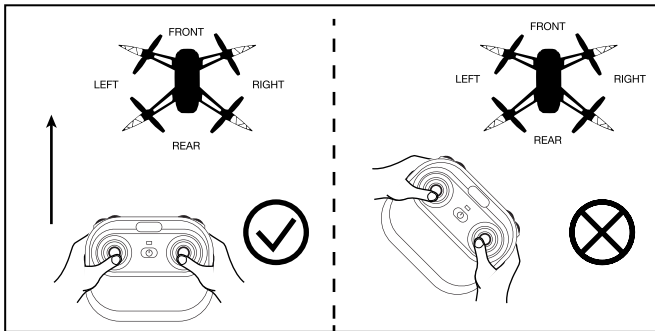

OPERATION: FLYING THE DRONE

TAKE-OFF:

1. Press the take off button. The remote will beep and the drone will hover a few feet off the ground. Then gently advance the throttle to a desired height and release. The drone will hover at that height.*

OR

2. From Idle mode, gently advance the throttle up to a desired height and release. The drone will hover at that height.*

LANDING:

1. Press the landing button to lower the drone to the ground.

OR

2. Push down on the throttle until the drone is on the ground.

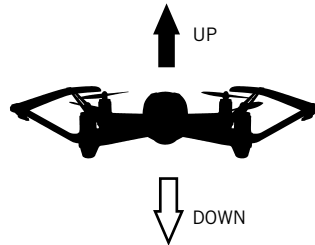
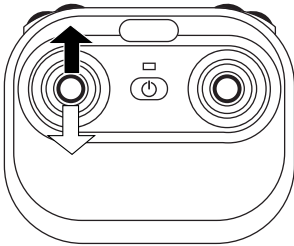

NOTE:

- **Press the Take Off/Landing Button and hold. The engine will shut off.**

* The drone may drift a bit, especially in the first 30 seconds until the altitude sensor gets a good fix on the position. Some drift is normal.

OPERATION: FLYING THE DRONE

FIRST TIME FLYERS!!! TAKE YOUR TIME! GO SLOW!

Practice hovering until you are comfortable with flight before attempting any other maneuvers. Make small movements letting the stick return to the center. If you start to lose control, don't panic. Just press land.

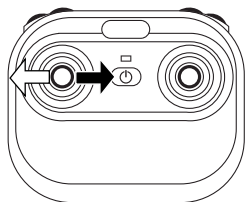

Pull the throttle left or right,
the drone turns to the left or right.

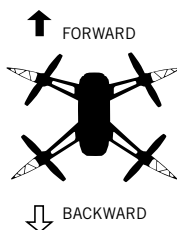
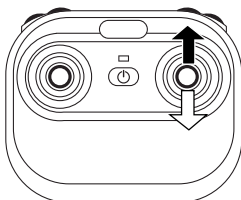

Push the direction lever up or down,
the drone flies forward or backward.

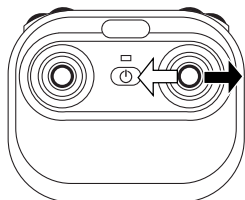

Pull the direction lever to the left or right,
the drone banks to the left or right.

SPEED MODES

The Dura HD features multiple speed modes. Choose the speed based on flight experience and level of comfort. At higher speeds, the drone will pitch more than at lower speeds. Dura HD is quite fast at its highest speed and require more piloting skills to fly competently. For safety take time to develop advanced skills by practicing at lower speeds first. Press the Speed button in to change the speed mode. The remote control indicator will beep once at slowest speed mode and multiple times as speed mode is increased.

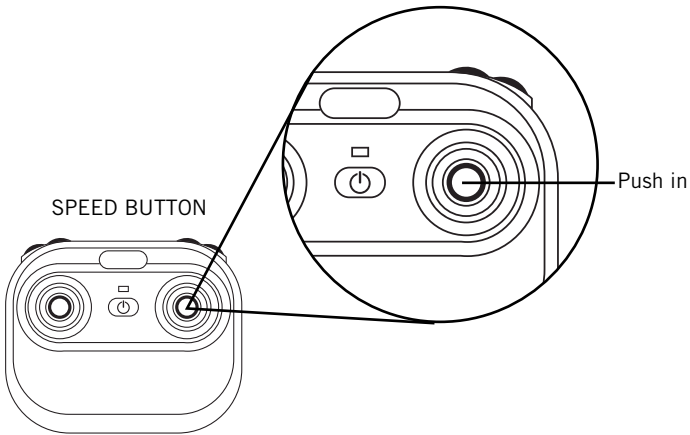

TRIM ADJUSTMENT

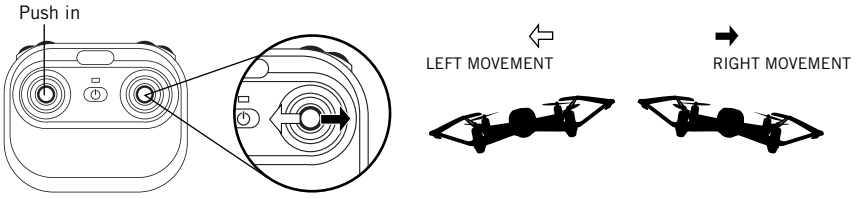

SIDEWAYS TRIM

When the drone drifts to the left or right side unintentionally, you can correct it by holding down the trim button and pushing the direction stick in the opposite direction until it evens out.

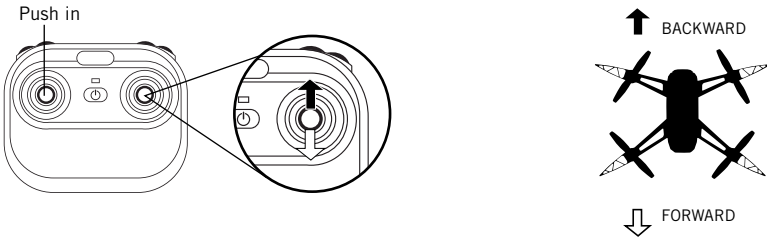

FORWARD/BACKWARD TRIM

When the drone drifts forward/backward unintentionally, you can correct it by holding down the trim button and pushing the direction stick in the opposite direction until it evens out.

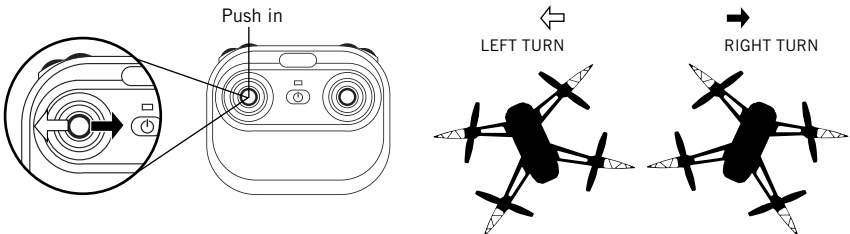

LEFT/RIGHT TURN TRIM

When the drone spins left/right unintentionally, you can correct it by holding down the trim button and pushing the throttle in the opposite direction until it evens out.

*NOTE: Trim adjustments are designed to counter drifts not caused by wind.

TROUBLESHOOTING

LOW BATTERY ALARM

The remote will start to beep in flight and the lights will flash when the battery is low. Land the drone as soon as possible and recharge the drone.

OUT OF RANGE ALARM

When the drone is close to flying out of range, the remote will beep rapidly. Fly the drone back into range immediately or you may lose control of the drone.

RE-CALIBRATING THE DRONE

If the drone crashes and after re-starting and trimming, it still is unstable, you have the option to re-calibrate the drone.

1. Turn on the drone and then the remote and sync.
2. Push and hold the direction stick to the lower right corner.
3. The lights will flash to indicate that the drone has re-calibrated.

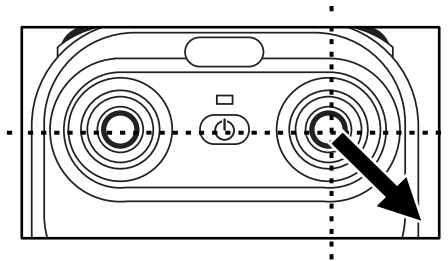

TROUBLESHOOTING

*Allow 15 minutes to pass between full flights as this will give the motors a chance to cool down. Failure to do so could wear out and shorten the life of the motors.

SYMPTOM	POSSIBLE CAUSE	POTENTIAL SOLUTION
Dura HD does not respond	<ol style="list-style-type: none"> 1. Communication between controller and aircraft was not synchronized during set up 2. Battery power depleted on aircraft, controller or both. 	<ol style="list-style-type: none"> 1. To synchronize, turn on aircraft first, place it on level ground, and then turn on controller. 2. Charge aircraft and/or replace batteries in controller.
Response to control inputs intermittent or erratic	<ol style="list-style-type: none"> 1. Controller battery power nearly depleted. 	<ol style="list-style-type: none"> 1. Replace batteries in controller.
Dura HD will not hover or strafe correctly	<ol style="list-style-type: none"> 1. The aircraft was not on level ground during synchronization. 2. Trim settings are incorrect. 	<ol style="list-style-type: none"> 1. Re-synchronize aircraft and controller. 2. Reset the trim buttons on the controller and re-trim flight controls.
The motors stop running	<ol style="list-style-type: none"> 1. If a propeller is stuck, the motors will automatically stop running. 	<ol style="list-style-type: none"> 1. Pull the throttle down and release to start the engines.

HOW TO CHANGE THE BLADES

- All drones have two rotors that spin clockwise and two rotors that spin counter-clockwise.
- Make sure to place the blades on the correct axis or they will not spin correctly and the drone will not lift.
- Each blade is marked with A or B. There may be a number after the letter but you can ignore the number.
- Make sure to follow the graphic below to see where to place the blades.

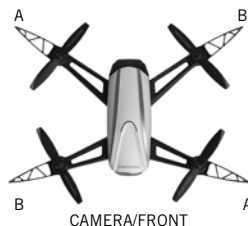

FLYING OUTDOORS

HOW TO PREVENT FLY AWAYS

To prevent “fly-away” situations (where drones seem to fly away out of control) it is important to first test and practice within close range before letting the drone fly too far away.

Each drone is designed to turn off the engines if the radio signal is lost. It is important to know and test the range of your drone before flying. We recommend turning on and syncing the drone and walking away while testing the engines. Keep walking and testing until it is obvious when you reach the point where the signal is not controlling the drone. This will be the control limit for the conditions in which you are flying. Distance does vary somewhat based on environmental and weather conditions, so testing the limit is advised. Fly in a range that is good for easy visual operation of the drone.

IF YOU CAN'T SEE YOUR DRONE, THEN YOU CAN'T CONTROL YOUR DRONE.

* Fly-aways are not covered by warranty as they are overwhelmingly caused by pilot error.

REPLACEMENT PARTS

Thank you for your purchase of Protocol's **Dura HD Drone**. We know that accidents can sometimes happen and that is why we offer spare parts kits on our website: **www.ProtocolNY.com**.

LIMITED WARRANTY

At Protocol, we're dedicated to bringing you innovative and well-designed products that make living fun and easy. We stand behind all of our products and warrant this to be free from defects in workmanship and materials for 30 days from the date of purchase. The warranty does not cover transportation damage, misuse, accident, or similar events. Specific legal rights pertaining to this warranty may vary by state.

For service claims or questions please consult our website **www.ProtocolNY.com**.

DURA™

DRONE WITH LIVE STREAMING CAMERA

Age
14+

*Please check our website ProtocolNY.com for updates and instructions to our Apps.

Install the App

1. The App is available in both Apple and Android App stores. Search "Protocol Dura" and download the App to your smartphone.

Shooting Video/Photo

1. Turn on the Dura and the remote control.
2. Once it is turned on, the Dura will blast a Wi-Fi signal, "Dura". Make sure your smartphone is connected to that signal.
3. Open the app and press "START" (Fig. 1).
4. The screen will live stream the camera view.
5. Select the desired camera view.
6. To film video, hit the video icon once. You can switch between cameras seamlessly while filming. To stop filming, hit the icon again (Fig. 2).
7. To snap pictures, press the photo icon once.

Shooting in VR

1. Insert the phone in a VR viewer.
2. Press the VR icon (Fig. 3). The phone will shoot and live stream in VR mode.
3. Press the VR icon again to leave VR mode.

Viewing and Saving Recorded Video/Photo

To see recorded video and images, press the picture icon. There are two subfolders, one for video and one for photos. (Fig. 4).

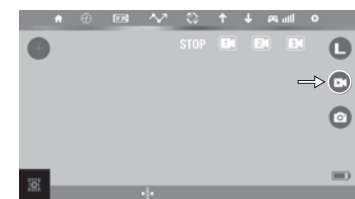

FIG. 2

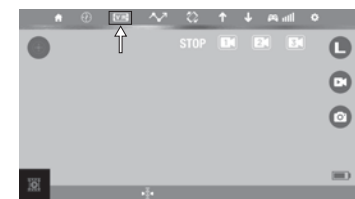

FIG. 3

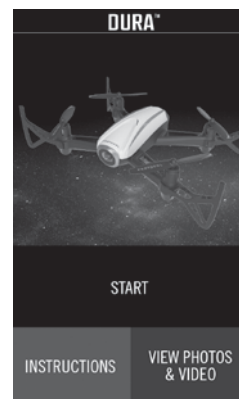

FIG. 1

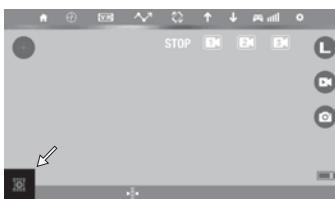

FIG. 4

Apple/Android

1. Photos and video will automatically save to the phone's photo album.
2. All videos can be viewed in VR mode through the App. Press the VR button when viewing the video. You cannot view VR video through the phone's photo album.

Deleting Content from the App

Press the trashcan icon, then select the images or video you want to delete. OR Open the image or video and then select the trashcan icon to delete.

Flying the Drone through the App (optional)

*This is for advanced users. Make sure you are comfortable flying the drone through the remote control before using the App.

1. The screen on the App is set up to work like the remote control interface (Fig. 5). Press the remote button to turn on the remote functions.
2. Press the up arrow to launch the drone.
3. Slide the throttle and direction sticks to control the drone as you would with the remote.
4. To trim the drone, slide the indicated trimmers.
5. To change the speed, tap the speed icon to change between low and high speeds (Fig. 6).
6. Press the down arrow to land the drone.



FIG. 5

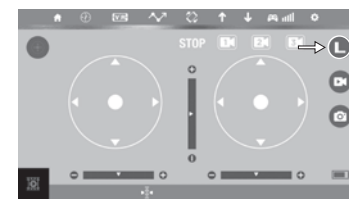

FIG. 6

EMERGENCY STOP

Press the stop button to shut off the engines mid-flight.

How to draw a flight path

1. Make sure the drone is hovering.
2. Press the "Flight Path" button in the app (Fig. 7).
3. Use your finger to draw the path on the right side of the screen. The drone will automatically start to follow the path.

Motion Sensitive Piloting

1. Press the motion-sensitive piloting icon. The drone will then move in the direction that the phone is moving. The ball in the right direction lever will show the direction (Fig. 8).

Compass Mode

Users have the option to exit the default orientation (blue lights at the front, yellow lights at the back). In Compass Mode, users can operate the drone without orientation. Regardless of where the drone is pointing, it will turn left or right according to the remote's command.

Compass Mode is good for beginners and is useful for drones that fly too far away for the user to be able to tell the orientation.

Follow the below instructions to change to Compass Mode:

1. It is easiest to set up Compass Mode before flight. Turn on the drone, access its Wi-Fi signal, and turn on the app.
2. Make sure your drone is facing forward and you are behind it.
3. Press the Compass Mode icon once (Fig.9). The drone's left and right LEDs will start to alternately flash. This indicates that the drone is now in Compass Mode.
4. Press the Compass Mode icon again to leave Compass Mode.

Troubleshooting

If the drone doesn't respond to the App while connected to the Wi-Fi, then you need to re-sync the drone and App. Turn everything off and reconnect to the App.

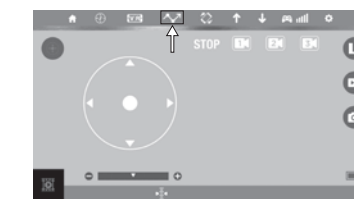

FIG. 7

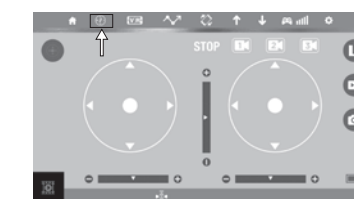

FIG. 9

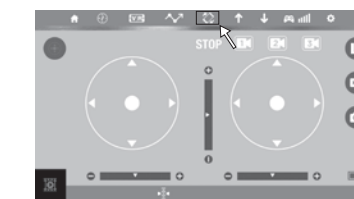
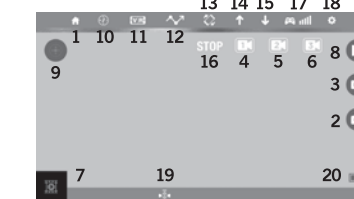

FIG. 8



Icon Key	
1. Return to previous menu	11. VR Mode (active or inactive)
2. Take photo	12. Flight Path
3. Record video	13. Motion Sensitive Piloting
4. Aerial	14. Take Off
5. POV	15. Landing
6. Selfie	16. Emergency Stop
7. View photos and video	17. Wi-Fi Strength
8. Speed Mode	18. Settings
9. Flight	19. Altitude Indicator
10. Compass Mode	20. Battery Life