

**PAPARAZZI AP™  
DRONE WITH CAMERA**

**INSTRUCTION MANUAL**

**PROTOCOL®**

PROTOCOL®  
**AIR** *FLY FIRST*™

# THANK YOU.

Thank you for your purchase of Protocol's **Paparazzi AP With Camera**. You are about to experience the best of what remote control flight has to offer. We strongly recommend that you take the time to read this manual thoroughly. It contains many tips and instructions on how to get the most out of this aircraft and maintain it for a long life.

As with any aircraft, this is a precision flying machine. Treat it well and enjoy all the fun it has to offer, flight after flight.



# TABLE OF CONTENTS

01	Safety & Precautions
02	Parts
04	Remote Battery Installation
05	Installing the Blade Guard
06	Charging the Drone
07	Turning On & Syncing the Drone
08	Operation
10	Tips on 3D Stunt & Tumbling
12	High, Medium, & Low Speed Modes
13	Trim Adjustment
14	Troubleshooting
15	Flying Outdoors
16	Shooting Photo/Video
17	Replacement Parts & Limited Warranty

## HAVE FUN, BUT SAFETY FIRST!

### PRECAUTIONARY SAFETY WARNINGS:

- To prevent damage to people or property, always avoid contact with other objects while in flight.
- Inspect aircraft prior to each flight and do not fly if damaged.
- Never expose product or any of its electronic parts to moisture, water or heat sources.
- Charge device in a cool, dry place and under adult supervision.
- Never leave the device unattended while charging.
- To prevent overheating, allow battery a cool-down period before recharging.
- Use only the charger and/or charging cable that is supplied with this item.
- Do not strike, cut or pierce the internal battery or subject it to hard impacts.
- Do not mix old and new batteries or mix different types of batteries.
- Never attempt to modify function of vehicle or controller or attempt repairs using parts other than those supplied by Protocol. Spare parts are available at [www.protocolny.com](http://www.protocolny.com)

**THIS DEVICE USES COMPONENTS THAT OPERATE AT HIGH SPEEDS.  
AS WITH ANY SUCH DEVICE, USE CAUTION TO OPERATE SAFELY.**

**FAILURE TO FOLLOW ANY OF THESE GUIDELINES MAY RESULT IN  
BODILY INJURY OR DAMAGE TO PERSONAL OR PUBLIC PROPERTY.**

**PROTOCOL**  
NEW YORK

## PARTS



### DRONE

1. Canopy
2. Blade Guard
3. Blade
4. Landing Gear
5. Battery Compartment
6. Camera

## PARTS

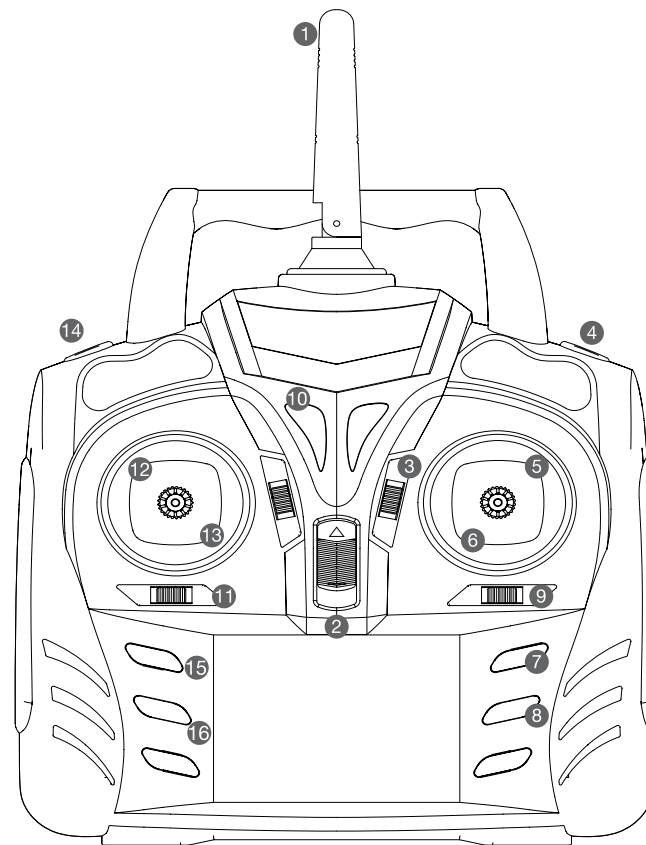

### REMOTE

1. 2.4G Antenna
2. Power Switch
3. Trim Forward/Backward
4. Flip 360°
5. Forward/Backward
6. Bank Left/Right
7. Video
8. Photo
9. Trim Bank Left/Right
10. Indicator Light
11. Trim Turn Left/Right
12. Throttle
13. Turn Left/Right
14. Hi/Med/Lo Speed Mode Selector
15. Take Off / Landing
16. Calibration

## REMOTE BATTERY INSTALLATION

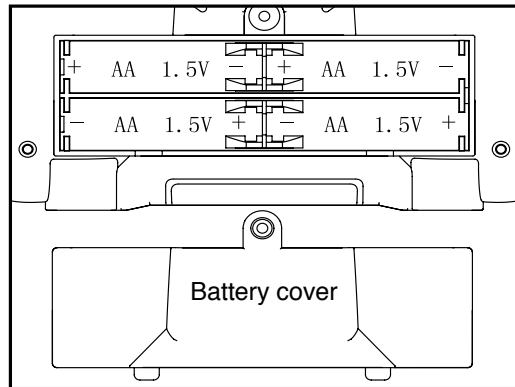

Unscrew and remove battery cover from controller. Insert 4 x 'AA' batteries according to indicated polarities. Replace and screw back in battery cover.

1. Install batteries carefully.
2. Do not mix old and new batteries.
3. Do not mix different types of batteries.

## INSTALLING THE BLADE GUARD

If not already installed, install the included blade guards to every corner and tighten the screws.

NOTE: If the drone crashes, double check to make sure the blade guard is not loose. If it is, re-tighten before flying.



## CHARGING THE DRONE BATTERY

1. Make sure the drone is turned off.
2. Open the battery cover and remove the battery.
3. Connect the USB charging cable to the battery.
4. Plug the charger into a USB port. The USB light will turn off while charging and will turn on once fully charged.

Charging time: 50 minutes --- Flying time: approximately 5 minutes

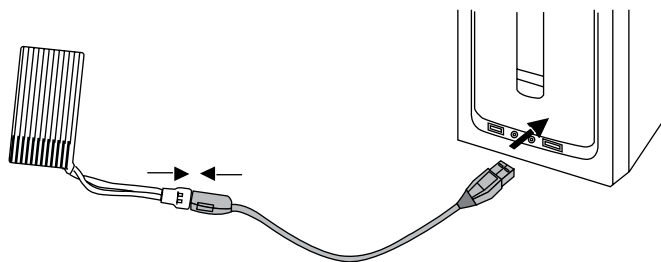

\*Battery: Li-Po, 3.7V, 380mAh

### CAUTION WHEN CHARGING

1. When charging, place product on a dry, well-ventilated surface and keep away from heat sources.
2. Always use adult supervision while charging.
3. In order to increase battery longevity, avoid repeat charging and excessive discharging.
4. As battery temperature is high immediately after flight, charge after cooling down for higher efficiency.
5. Do not strike or subject battery to hard impacts or sharp surfaces.
6. Do not use any other charger than that which is supplied with this item.
7. Do not use or leave battery near a heat source such as fire or space heater; exposure to heat may result in reduced performance or in some cases dangerous conditions.
8. If battery is left in charging state for an extended period of time after being fully charged, the battery may automatically discharge.
9. Never leave the battery unattended during charging.
10. Do not disassemble battery.
11. Do not submerge battery in water.

## TURNING ON & SYNCING THE DRONE

1. Turn on the drone by connecting the battery wire to the drone and place it on an even surface.
2. Turn on the remote control.
3. Both indicators on the drone and the remote will flash while they are syncing.
4. Push the throttle up and then down to sync. You will hear two beeps and the lights will go steady.

Tip: When syncing your drone keep it in a horizontal position for stable flight.

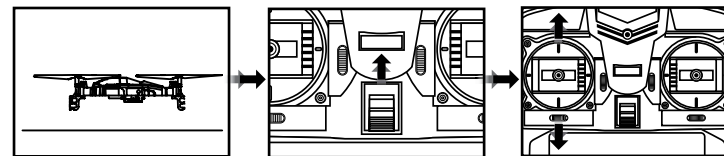

### NOTE

1. If the Paparazzi AP and the remote do not sync after following the checklist, reverse steps 1 and 2 of the process. Turn the remote and the drone off. Then, turn on the remote first and then the drone.
2. Turn on the controller; if, after 30 seconds, it has not recognized the drone, turn off the controller to retry synchronization.
3. If the Paparazzi AP is unsteady in flight, it may not have been able to calibrate horizontally. Power down both drone and remote and restart pre-flight procedure.

## OPERATION: FLYING THE DRONE

### Starting the Engine:

1. Once the drone is synced, press the calibration button. This will align the drone and trim settings for flight.
2. Move the throttle and direction sticks to the lower left and lower right corners (blue lines) and release to go into idle mode. The blades will rotate but the drone will not lift.

### Take – Off:

1. Press the take off button once and the drone will hover 3-4 feet off the ground. Then gently advance the throttle to a desired height and release. The drone will hover at that height.\*

OR

2. Gently advance the throttle up to a desired height and release. The drone will hover at that height.

\*In the first 30 seconds, the drone will sway up and down as it adjusts to flight. After that, the drone may sway up and down slightly but will maintain altitude.

### Landing:

1. Press the landing button to lower the drone to the ground.

OR

2. Push down on the throttle until the drone is on the ground.

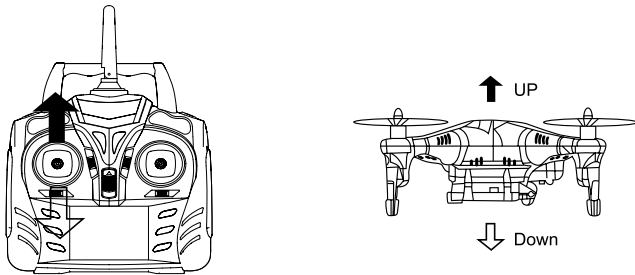

\*The engine will shut off if you choose to hold the throttle down for 3 seconds.

\*\*Emergency Shut Off: When in flight, pull the throttle and direction stick to the center at the same time (red lines) and the drone will shut off.

FIRST TIME FLYERS!!! Practice hovering until you are comfortable with flight before attempting any other maneuvers.

## OPERATION: FLYING THE DRONE

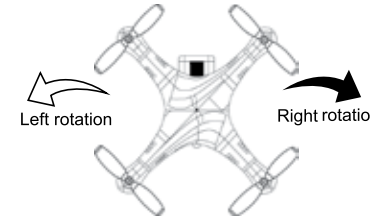
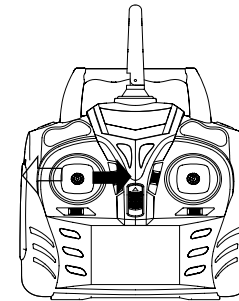

Pull the throttle left or right,  
the drone turns to the left or right.

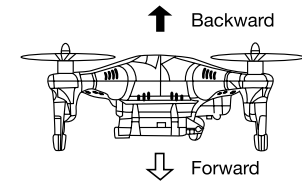
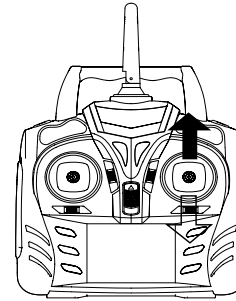

Push the direction lever up or down, the  
drone flies forward or backward.

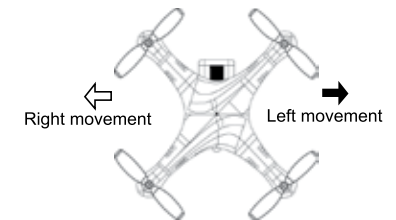
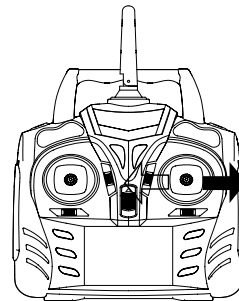

Pull the direction lever to the left or right,  
the drone banks to the left or right.

## TIPS ON 3D STUNT & TUMBLING

Once you are familiar with the basics of drone flight, you can try some advanced maneuvers! At a height of at least 10 feet, press the Flip 360° button and move the direction lever in any desired direction to execute the flip. The remote will beep quickly when you are in stunt mode and will stop beeping once you have executed the flip.

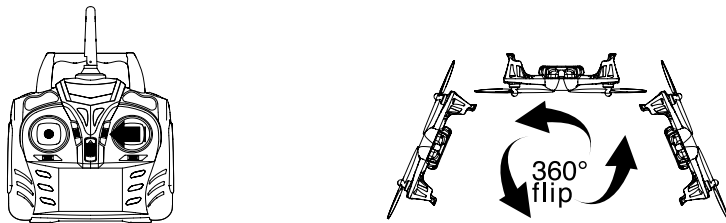
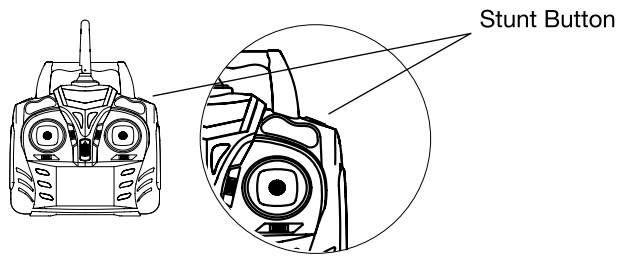

### LEFT FLIP

Push the direction stick to the left and the drone will perform a 360° flip in that direction.

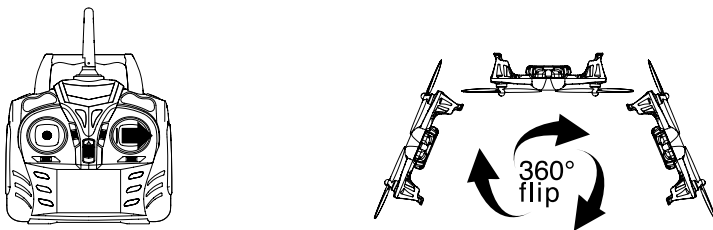

### RIGHT FLIP

Push the direction stick to the right and the drone will perform a 360° flip in that direction.

## TIPS ON 3D STUNT & TUMBLING

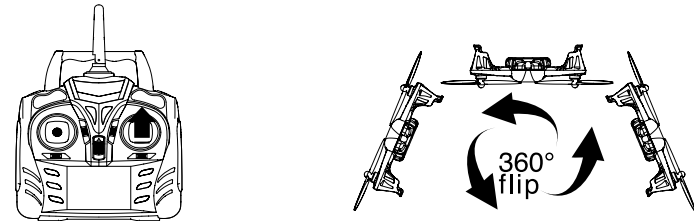

### FORWARD FLIP

Push the direction stick forward and the drone will perform a 360° flip in that direction.

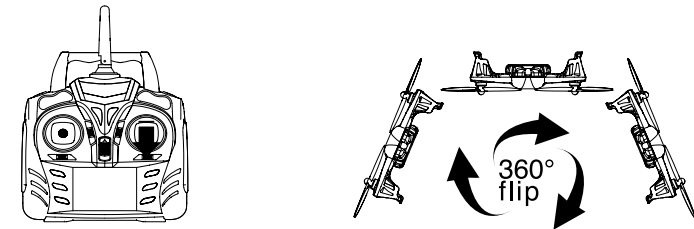

### BACKWARD FLIP

Push the direction stick backward and the drone will perform a 360° flip in that direction.



## HIGH, MEDIUM, LOW SPEED MODES

The Paparazzi AP features 3 speed modes. Low speed is at 40%, Medium is at 70%, and High is at 100%. Choose the speed based on flight experience and level of comfort.

Press the Speed +/- button to change the speed mode. The remote control indicator will beep once for low speed, twice for medium, and three times for high.

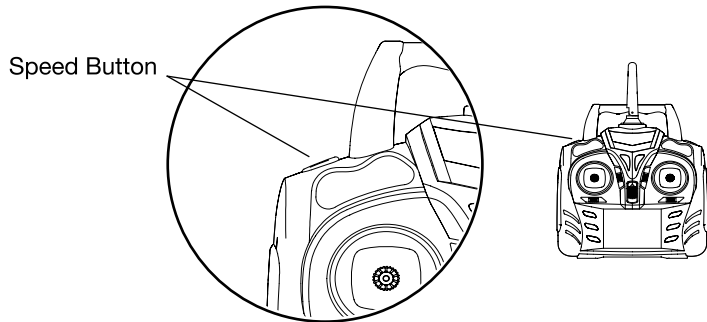

## TRIM ADJUSTMENT

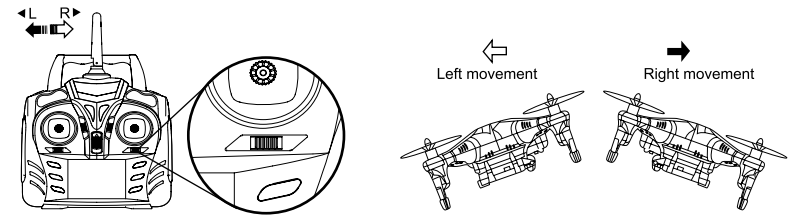

### SIDEWAYS TRIM

When the drone veers to the left or right side unintentionally, you can correct it by pressing the trim button in the opposite direction until it evens out.

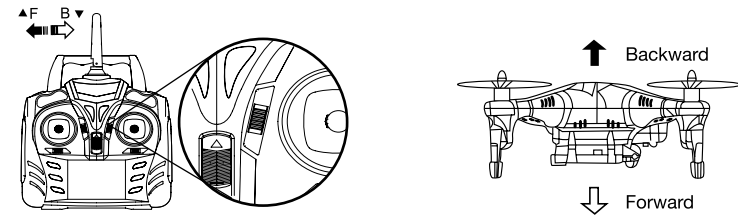

### FORWARD/BACKWARD TRIM

When the drone veers forward/backward unintentionally, you can correct it by pressing the trim button in the opposite direction until it evens out.

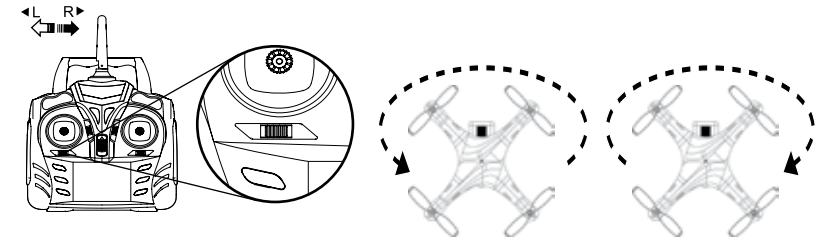

### LEFT/RIGHT TRIM

When the drone spins left/right unintentionally, you can correct it by pressing the trim button in the opposite direction until it evens out.

## TROUBLESHOOTING

\*Allow 15 minutes to pass between full flights as this will give the motors a chance to cool down. Failure to do so could wear out and shorten the life of the motors.

SYMPTOM	POSSIBLE CAUSE	POTENTIAL SOLUTION
Paparazzi AP does not respond	<ol style="list-style-type: none"><li>1. Communication between controller and aircraft was not synchronized during set up</li><li>2. Battery power depleted on aircraft, controller or both.</li></ol>	<ol style="list-style-type: none"><li>1. To synchronize, turn on controller, then turn on aircraft and place it on level ground.</li><li>2. Charge aircraft and/or replace batteries in controller.</li></ol>
Response to control inputs intermittent or erratic	<ol style="list-style-type: none"><li>1. Controller battery power nearly depleted.</li></ol>	<ol style="list-style-type: none"><li>1. Replace batteries in controller.</li></ol>
Paparazzi AP will not hover or strafe correctly	<ol style="list-style-type: none"><li>1. The aircraft was not on level ground during synchronization.</li><li>2. Trim settings are incorrect.</li></ol>	<ol style="list-style-type: none"><li>1. Re-synchronize aircraft and controller.</li><li>2. Reset the trim buttons on the controller and re-trim flight controls.</li></ol>

## FLYING OUTDOORS

### HOW TO PREVENT FLY AWAYS

To prevent “fly-away” situations (where drones seem to fly away out of control) it is important to first test and practice within close range before letting the drone fly too far away.

Each drone is designed to turn off the engines if the radio signal is lost. It is important to know and test the range of your drone before flying. We recommend turning on and syncing the drone and walking away while testing the engines. Keep walking and testing until it is obvious when you reach the point where the signal is not controlling the drone. This will be the control limit for the conditions in which you are flying. Distance does vary somewhat based on environmental and weather conditions, so testing the limit is advised. Fly in a range that is good for easy visual operation of the drone.

### IF YOU CAN'T SEE YOUR DRONE, THEN YOU CAN'T CONTROL YOUR DRONE.

\* Fly-aways are not covered by warranty as they are overwhelmingly caused by pilot error.

## SHOOTING PHOTO/VIDEO

1. The memory card comes pre-inserted into the camera.

### SHOOTING PHOTOS AND VIDEO

1. Turn on the drone and sync.
2. Photo: Push the Photo button and the camera will take a photo. The lights on the drone will flash once as it's taking the picture.
3. Video: Push the Video and the camera will begin to record. The lights will continuously flash while recording video. Push the Video button again and the camera will stop recording.
4. Connect the USB transfer cable to the drone and plug it into the USB port of your computer. If you are using Windows, the USB will come up on the removable drive. If you are using OS, then the USB will come up as "Untitled".
5. Open the drive and then open the Video or Photo folders to access the .AVI or JPEG files.
6. .AVI movies can be played in several different formats including Quicktime, Windows Media Player, and RealPlayer.

WARNING: Never remove the card from the video camera while the drone is turned on.

## REPLACEMENT PARTS

Thank you for your purchase of Protocol's **Paparazzi AP with Camera**. We know that accidents can sometimes happen and that is why we offer spare parts kits on our website: **ProtocolNY.com**.

## LIMITED WARRANTY

At Protocol, we're dedicated to bringing you innovative and well-designed products that make living fun and easy. We stand behind all of our products and warrant this to be free from defects in workmanship and materials for 30 days from the date of purchase. The warranty does not cover transportation damage, misuse, accident, or similar events. Specific legal rights pertaining to this warranty may vary by state.

For service claims or questions please consult our website **ProtocolNY.com**.

**PROTOCOL®**