

**AXIS™
RC DRONE**

INSTRUCTION MANUAL

PROTOCOL®

PROTOCOL®
AIR™ *FLY FIRST*™

THANK YOU.

Thank you for your purchase of Protocol's **Axis RC Drone**. You are about to experience the best of what remote control flight has to offer. We strongly recommend that you take the time to read this manual thoroughly. It contains many tips and instructions on how to get the most out of this aircraft and maintain it for a long life.

As with any aircraft, this is a precision flying machine. Treat it well and enjoy all the fun it has to offer, flight after flight.



TABLE OF CONTENTS

01	Safety & Precautions
02	Parts
04	Installing Remote Batteries & Landing Gear
05	Charging the Drone
06	Turning On & Syncing the Drone
07	Operation
09	Tips on 3D Stunt & Tumbling
11	Low, Medium, & High Speed Modes
12	Trim Adjustment
13	Troubleshooting
14	Flying Outdoors
15	Replacement Parts & Limited Warranty

HAVE FUN, BUT SAFETY FIRST!

PRECAUTIONARY SAFETY WARNINGS:

- To prevent damage to people or property, always avoid contact with other objects while in flight.
- Inspect aircraft prior to each flight and do not fly if damaged.
- Never expose product or any of its electronic parts to moisture, water or heat sources.
- Charge device in a cool, dry place and under adult supervision.
- Never leave the device unattended while charging.
- To prevent overheating, allow battery a cool-down period before recharging.
- Use only the charger and/or charging cable that is supplied with this item.
- Do not strike, cut or pierce the internal battery or subject it to hard impacts.
- Do not mix old and new batteries or mix different types of batteries.
- Never attempt to modify function of vehicle or controller or attempt repairs using parts other than those supplied by Protocol. Spare parts are available at www.protocolny.com

**THIS DEVICE USES COMPONENTS THAT OPERATE AT HIGH SPEEDS.
AS WITH ANY SUCH DEVICE, USE CAUTION TO OPERATE SAFELY.**

**FAILURE TO FOLLOW ANY OF THESE GUIDELINES MAY RESULT IN
BODILY INJURY OR DAMAGE TO PERSONAL OR PUBLIC PROPERTY.**

PROTOCOL
NEW YORK

PARTS



DRONE

1. Canopy
2. Blade Guard
3. Blades
4. Battery

PARTS

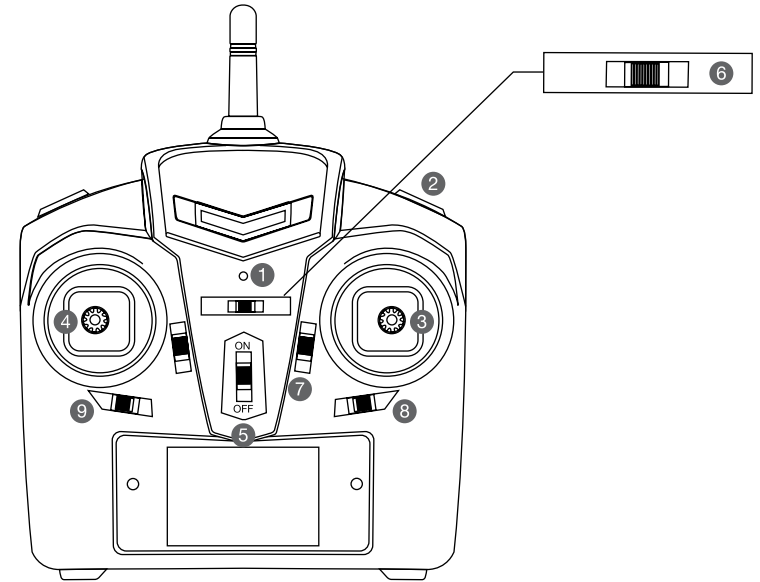

REMOTE

1. Indicator Light
2. 3D Stunt
3. Direction Lever
4. Throttle
5. Power Switch
6. Low/Med/High Speed Mode Selector
7. Trimmer: Forward/Backward
8. Trimmer: Left/Right Bank
9. Auto Land

INSTALLING REMOTE BATTERIES & LANDING GEAR

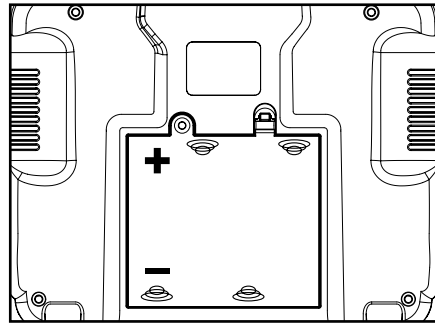

battery cover

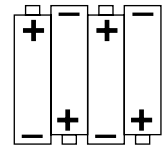
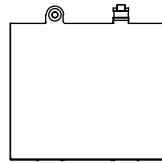

4 x 'AA' batteries

Unscrew and remove battery cover from controller. Insert 4 x 'AA' batteries according to indicated polarities. Replace and screw back in battery cover.

1. Install batteries carefully.
2. Do not mix old and new batteries.
3. Do not mix different types of batteries.

LANDING GEAR

Insert the landing gear into the bottom of the drone.

CHARGING THE DRONE BATTERY

1. Make sure the drone is turned off.
2. Connect the USB charging cable to the drone battery.
3. Plug the charger into a USB port. The USB light will turn off while charging and will turn on once fully charged.

Charging time: approximately 50 minutes --- Flying time: approximately 5-7 minutes

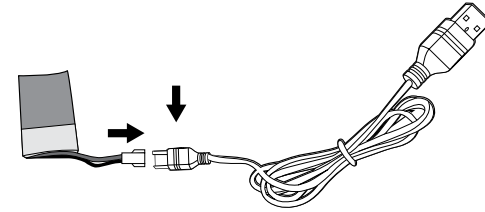

*Battery: Li-Po, 3.7V, 300mAh

CAUTION WHEN CHARGING

1. When charging, place product on a dry, well-ventilated surface and keep away from heat sources.
2. Always use adult supervision while charging.
3. In order to increase battery longevity, avoid repeat charging and excessive discharging.
4. As battery temperature is high immediately after flight, charge after cooling down for higher efficiency.
5. Do not strike or subject battery to hard impacts or sharp surfaces.
6. Do not use any other charger than that which is supplied with this item.
7. Do not use or leave battery near a heat source such as fire or space heater; exposure to heat may result in reduced performance or in some cases dangerous conditions.
8. If battery is left in charging state for an extended period of time after being fully charged, the battery may automatically discharge.
9. Never leave the battery unattended during charging.
10. Do not disassemble battery.
11. Do not submerge battery in water.

TURNING ON & SYNCING THE DRONE

1. Connect the battery wire to the drone and turn it on. Place drone on an even surface.
2. Turn on the remote control.
3. Both indicators on the drone and the remote will flash while they are syncing.
4. Push the throttle up and then down to sync.

Tip: When syncing your drone keep it in a horizontal position for stable flight.

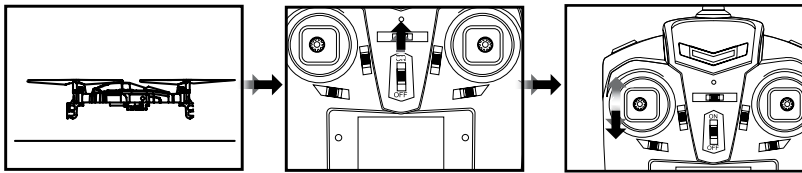

NOTE

1. If the Axis and the remote do not sync after following the checklist, reverse steps 1 and 2 of the process. Turn the remote and the drone off. Then, turn on the remote first and then the drone.
2. Turn on the controller; if, after 30 seconds, it has not recognized the drone, turn off the controller to retry synchronization.
3. If the Axis is unsteady in flight, it may not have been able to calibrate horizontally. Power down both drone and remote and restart pre-flight procedure.

OPERATION

FIRST TIME FLYERS!!!

Practice hovering until you are comfortable with flight before attempting any other maneuvers.



Push the throttle up or down,
the drone flies upward or downward.



Pull the throttle left or right,
the drone turns to the left or right.

OPERATION



Push the direction lever up or down, the drone flies forward or backward.



Pull the direction lever to the left or right, the drone banks to the left or right.

AUTO LAND

Push the auto land button to the right to land the drone.

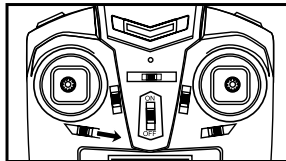

TIPS ON 3D STUNT & TUMBLING

Once you are familiar with the basics of drone flight, you can try some advanced maneuvers! At a height of at least 10 feet, press the 3D Stunt button. The remote will beep while you are in stunt mode. Execute a flip and the drone will leave stunt mode.

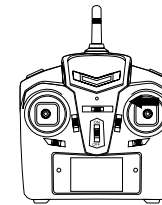
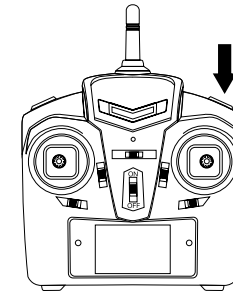

LEFT FLIP

Push the direction stick to the left and the drone will perform a 360° flip in that direction.

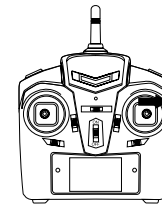

RIGHT FLIP

Push the direction stick to the right and the drone will perform a 360° flip in that direction.

TIPS ON 3D STUNT & TUMBLING

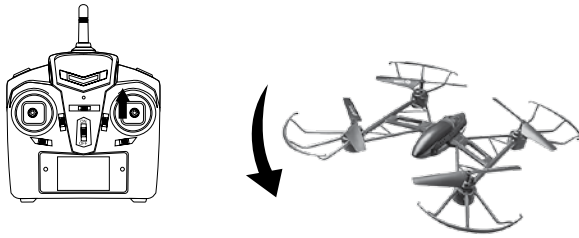

FORWARD FLIP

Push the direction stick forward and the drone will perform a 360° flip in that direction.

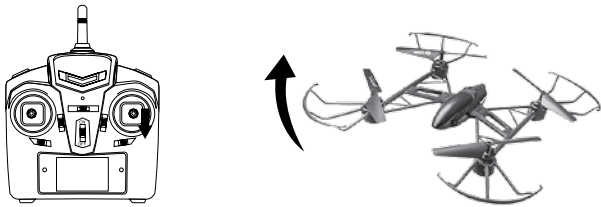

BACKWARD FLIP

Push the direction stick backward and the drone will perform a 360° flip in that direction.

LOW, MEDIUM, & HIGH SPEED MODES

The Axis features 3 speed modes. Low speed is at 40%, Medium is at 70%, and High is at 100%. Choose the speed based on flight experience and level of comfort.

Flip the Speed Switch to change the speed mode. The remote control indicator will beep once for low speed, twice for medium, and three times for high.

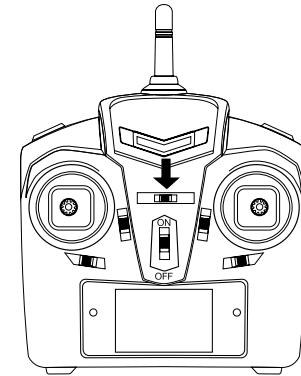

TOSS N' LAUNCH

Thanks to the 6-axis gyro, you can toss the drone and push the throttle up. It will automatically level out and hover smoothly in the sky.

TRIM ADJUSTMENT

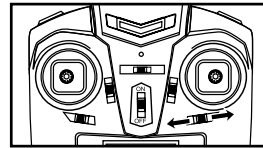

SIDEWAYS TRIM

When the drone veers to the left or right side unintentionally, you can correct it by pressing the trim button in the opposite direction until it evens out.

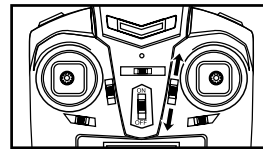

FORWARD/BACKWARD TRIM

When the drone veers forward/backward unintentionally, you can correct it by pressing the trim button in the opposite direction until it evens out.

*If the trim buttons do not correct the problem, you will have to recalibrate your drone. Place the drone on a flat surface. Push the throttle and direction stick to the lower right. The light on the remote will flash. Hold this position for three seconds and release. The light will stop flashing and the drone will have recalibrated.

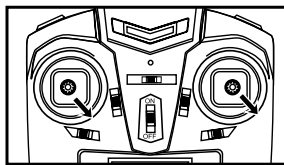

TROUBLESHOOTING

*Allow 15 minutes to pass between full flights as this will give the motors a chance to cool down. Failure to do so could wear out and shorten the life of the motors.

SYMPTOM	POSSIBLE CAUSE	POTENTIAL SOLUTION
Axis does not respond	<ol style="list-style-type: none"> 1. Communication between controller and aircraft was not synchronized during set up 2. Battery power depleted on aircraft, controller or both. 	<ol style="list-style-type: none"> 1. To synchronize, turn on controller, then turn on aircraft and place it on level ground. 2. Charge aircraft and/or replace batteries in controller.
Response to control inputs intermittent or erratic	<ol style="list-style-type: none"> 1. Controller battery power nearly depleted. 	<ol style="list-style-type: none"> 1. Replace batteries in controller.
The Axis will not hover or strafe correctly	<ol style="list-style-type: none"> 1. The aircraft was not on level ground during synchronization. 2. Trim settings are incorrect. 	<ol style="list-style-type: none"> 1. Re-synchronize aircraft and controller. 2. Reset the trim buttons on the controller and re-trim flight controls.

FLYING OUTDOORS

HOW TO PREVENT FLY AWAYS

To prevent “fly-away” situations (where drones seem to fly away out of control) it is important to first test and practice within close range before letting the drone fly too far away.

Each drone is designed to turn off the engines if the radio signal is lost. It is important to know and test the range of your drone before flying. We recommend turning on and syncing the drone and walking away while testing the engines. Keep walking and testing until it is obvious when you reach the point where the signal is not controlling the drone. This will be the control limit for the conditions in which you are flying. Distance does vary somewhat based on environmental and weather conditions, so testing the limit is advised. Fly in a range that is good for easy visual operation of the drone.

IF YOU CAN'T SEE YOUR DRONE, THEN YOU CAN'T CONTROL YOUR DRONE.

* Fly-aways are not covered by warranty as they are overwhelmingly caused by pilot error.

REPLACEMENT PARTS

Thank you for your purchase of Protocol's **Axis RC Drone**. We know that accidents can sometimes happen and that is why we offer spare parts kits on our website: **ProtocolNY.com**.

LIMITED WARRANTY

At Protocol, we're dedicated to bringing you innovative and well-designed products that make living fun and easy. We stand behind all of our products and warrant this to be free from defects in workmanship and materials for 30 days from the date of purchase. The warranty does not cover transportation damage, misuse, accident, or similar events. Specific legal rights pertaining to this warranty may vary by state.

For service claims or questions please consult our website **ProtocolNY.com**.

PROTOCOL®