

AGES
6+

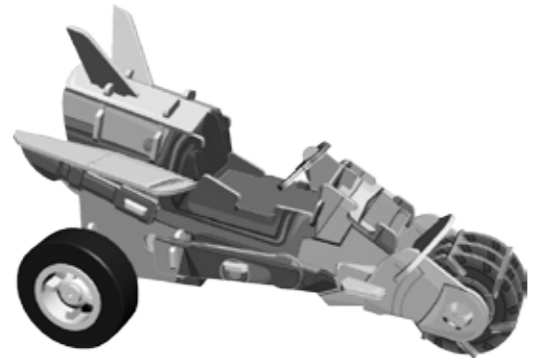

Read through this entire instruction manual BEFORE using Trike Striker 3D Wind Up Puzzles.

We're dedicated to bringing you well-designed products that make living fun and easy. We stand behind all our products and warrant this to be free from defects in workmanship and materials for 30 days from the date of purchase.

For service claims or questions please consult our website ProtocolNY.com.

Images may vary from actual product

PARTS

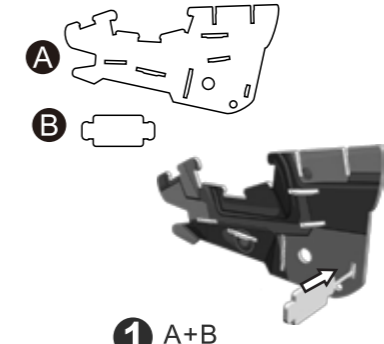
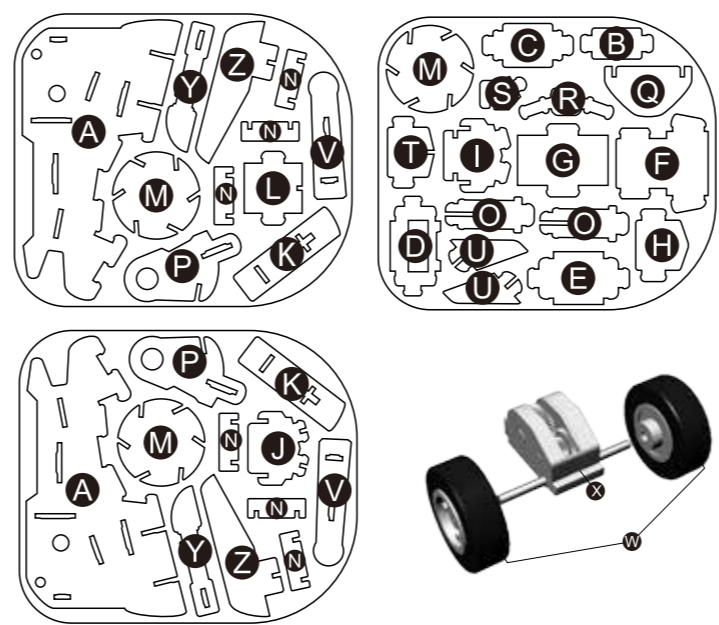

1 A+B
Attach pieces A and B.
Note: Make sure all pieces are pressed in all the way in order to securely interlock and leave room for later pieces.

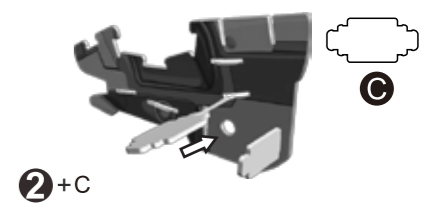

2 +C

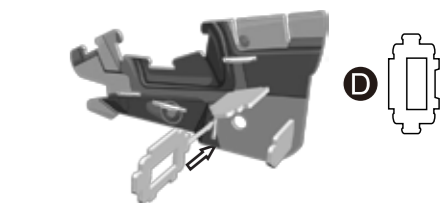

3 +D

PROTOCOL

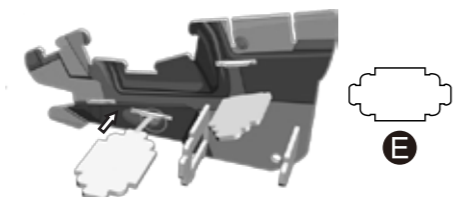

4 +E



5 +F

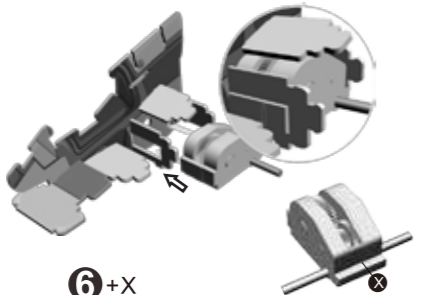

6 +X
Attach motor X by pushing the metal piece through the holes in piece A.

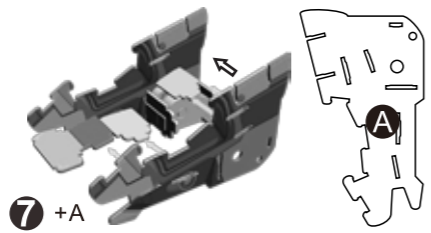

7 +A
Attach the second piece A around the motor.

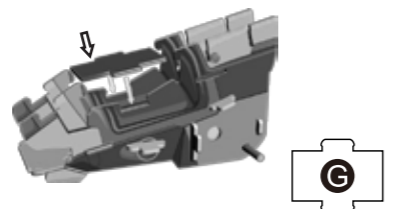

8 +G

ASSEMBLY

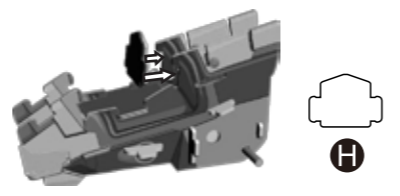

9 +H

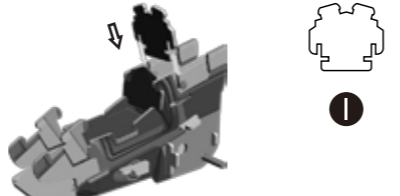

10 +I

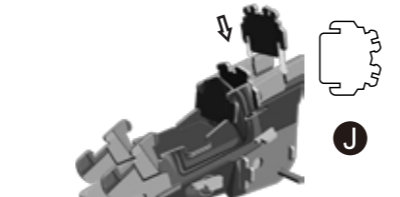

11 +J

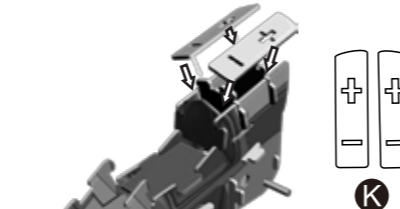

12 +K+K

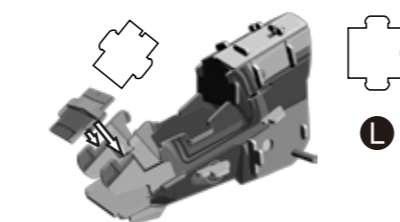

13 +L



14 Mx3+Nx6
Align three of pieces M and lock them together to create a wheel using six of pieces N.

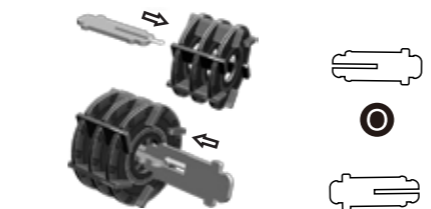

15 +O+O
Connect pieces O and O inside the core of pieces M and lock them together inside the wheel to create an axle.

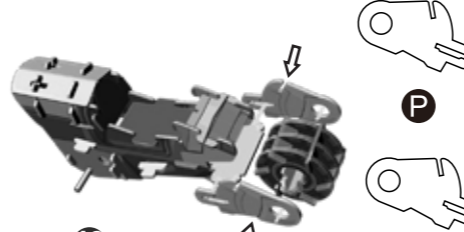

16 +P+P
Attach pieces P to either side of the wheel and connect it to the structure made in step 13.



17 R+S+T

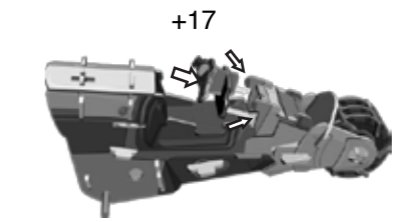

18 16 +17
Connect the structure from step 17 with the larger structure from step 16.



19 +U+U



20 +V+V

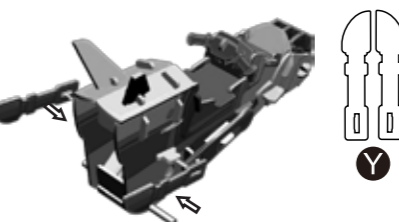

21 +Y+Y

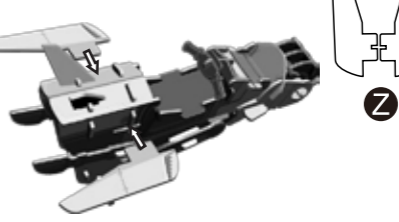

22 +Z+Z

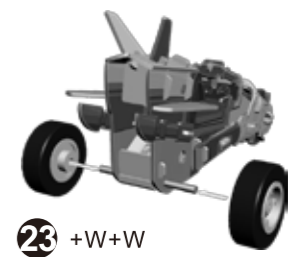

23 +W+W



24
Wind motor to walk.

