



Kingsbury Electric Adjustable
Beauty Bed
MODEL B82214

User Manual

Please read this user manual carefully before using the product.

www.barneyssalonsupplies.com.au | 1800 676 522

1. About This Manual

This manual should only be used in reference of the operation of this particular model. If the manual is used for other purposes, or instructions not followed correctly, Barneys Salon Supplies will not undertake any consequences or responsibility.

All information in this manual shall be protected by copyright and shall not be copied and translated in any part of this specification without the written consent of the manufacturer.

2. Warning

- Do not stand on the product.
- Do not allow children play with the product.
- Do not place the equipment in damp places such as bathroom or expose to direct sunlight.
- Do not use product on an unstable surface.

3. Precautions

- Read this manual carefully before installation, operation and adjustment.
- This product should be used by an experienced person who is familiar with the product structure and performance.
- The operator must use the product only for its intended use.
- Please operate the product strictly in accordance with the warning label stamped on it.
- Do not overload the product and ensure that the product has been correctly and safely installed.
- Tighten bolts and nuts regularly to avoid product failure and to keep product secure.
- Do not operate this product if faulty. Should the product appear to operate unusually, cease using the product and inspect immediately. Do not use the product until issues have been resolved.
- Regular maintenance and troubleshooting should be processed by trained professionals.
- After every treatment, clear the dust or stains on the product using a neutral cleaning solution.
- When adjusting parts of the equipment for positioning, please keep your hands, feet and head clear from the areas indicated as shown in the image below.
- This product is equipped with a three-wire power cord. The power cord must be plugged into a three-hole outlet which is properly installed and grounded. This is not only to prevent the risk of electric shock, but ensure product can work properly.
- Whilst controlling lifting mechanism, ensure the button is pressed continuously until the product is in maximum position.
- Please pay attention to the continuous working times. Recommendations should be Maximum 2 Minutes ON; 18 Minutes OFF, when operating the motor. Recommended maximum continuous operating time should not exceed 2 Minutes.

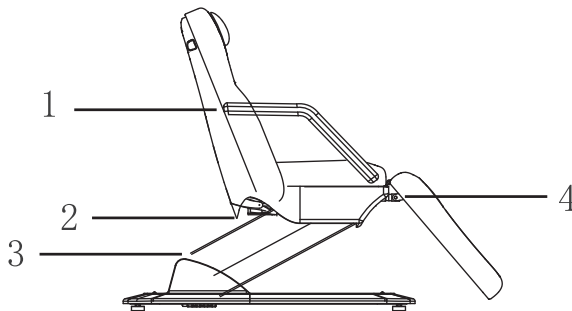

4. Installation

1. Place the product in a safe location, according to the overall layout of the treatment room.
Keep it in a clean, dry and cool environment.
2. Open the packing carton and remove all parts prior to installation.
3. Ensure all parts are included and the packing carton is checked thoroughly prior to disposing.
4. Installation: Please ensure the product is placed on a firm and flat surface for stability.
If the product seems to be unstable due to an uneven surface, please adjust the four feet on the bottom panel until stable.
5. Connection: Connect the plug of the product with a suitable power supply (See image examples).

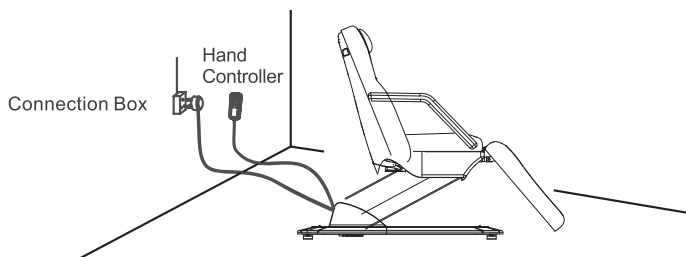

5. Operation Instructions

- This product includes angle adjustment of the backrest, angle adjustment of the footrest cushion and lifting adjustment.
(As shown in the image).

- ① Angle adjustment of the backrest
- ② Lifting adjustment
- ③ Angle adjustment of the footrest

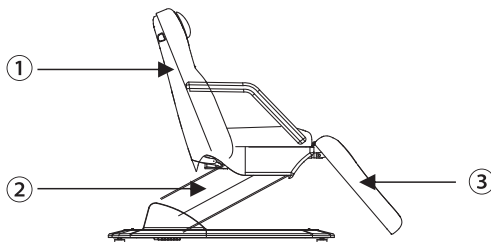

1. Standard Configuration
(Hand Controller)

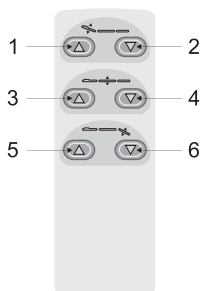

2. Optional Extra Configuration
(Foot Controller)

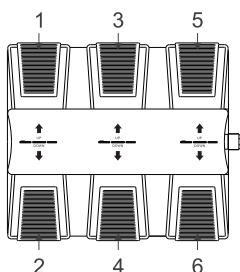

5. Operation Instructions

No.	Description	Operation
1	Backrest angle adjusts back	Backrest angle smoothly adjusts back by pressing button
2	Backrest angle adjusts in	Backrest angle smoothly adjusts in by pressing button
3	Bed moves up	Bed moves up by slowly pressing the button
4	Bed moves down	Bed moves down by slowly pressing the button
5	Footrest moves up	Footrest moves up by pressing the button. Its angle will be reduced to its minimum.
6	Footrest moves down	Footrest moves down by pressing the button. Its angle will be reduced to its maximum.

7. Technical Parameters

Power	AC 100-120V or AC 220-240V or AC 100-240V,50/60Hz
Maximum Power	300W
Environment Temperature	0 C ~ + 40 C
Relative Humidity	30% ~ 90%
Lifting Rated Load	Up to 175kg

• B82214

Package Size	(Style 1) 172×65×64.5cm
--------------	---------------------------

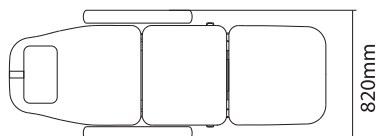
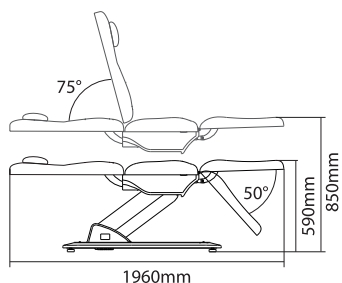

8. Maintenance

1. After every treatment, use a neutral solution to clean dust and stains.
Avoid using cleaning solutions such as alcohol, acid or alkaline solutions that could damage the surface. This is to prevent the lifetime of the components from being shortened.
2. Please lubricate the moving parts regularly (at least once a year).



Do not dispose of old or defective appliances in domestic garbage; this should only be done through public collection points.

▲ Please check the product specification before use. This manual is for reference only. Specifications are subject to change without prior notice.