

barneys

salon supplies

Barneys Beauty Trolley - 1 Drawer

MODELS B81020

User Manual



Please read this user manual carefully before using the product.

www.barneyssalonsupplies.com.au | 1800 676 522

1. About This Manual

This manual should only be used in reference of the operation of this particular model. If the manual is used for other purposes, or instructions not followed correctly, Barneys Salon Supplies will not undertake any consequences or responsibility.

All information in this manual shall be protected by copyright and shall not be copied and translated in any part of this specification without the written consent of the manufacturer.

2. Warning

- Do not stand on the product.
- Do not allow children play with the product.
- Do not place the equipment in damp places such as bathroom or expose to direct sunlight.
- Do not use product on an unstable surface.







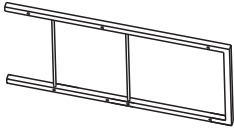

3. Precautions

- Read this manual carefully before installation, operation and adjustment.
- This product should be used by an experienced person who is familiar with the product structure and performance.
- The operator must use the product only for its intended use.
- Please operate the product strictly in accordance with the warning label stamped on it.
- Do not overload the product and ensure that the product has been correctly and safely installed.
- Tighten bolts, nuts and castors regularly to avoid product failure and to keep product secure.
- Do not operate this product if faulty. Should the product appear to behave unusually, cease using the product and inspect immediately. Do not use the product until issues have been resolved.
- Position and use equipment safely by placing on level ground.
- After every treatment, clear the dust or stains on the product using a neutral cleaning solution.

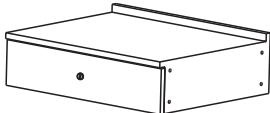
4. Installation

1. Place the product in a safe location, according to the overall layout of the treatment room.
Keep it in a clean, dry and cool environment.
2. Open the packing carton and remove all parts prior to installation.
3. Ensure all parts are included and the packing carton is checked thoroughly prior to disposing.

- B81020 Components List

| NO. | Name | Sample | Quantity |
|-----|---------------|---|----------|
| A | Side frame |  | 2 |
| B | Wheel |  | 4 |
| C | Wood cabinet |  | 1 |
| D | M6*12 screw |  | 29 |
| E | Circular tube |  | 6 |
| F | Layer board |  | 2 |
| G | M6*18 screw |  | 9 |
| H | Fixture |  | 8 |

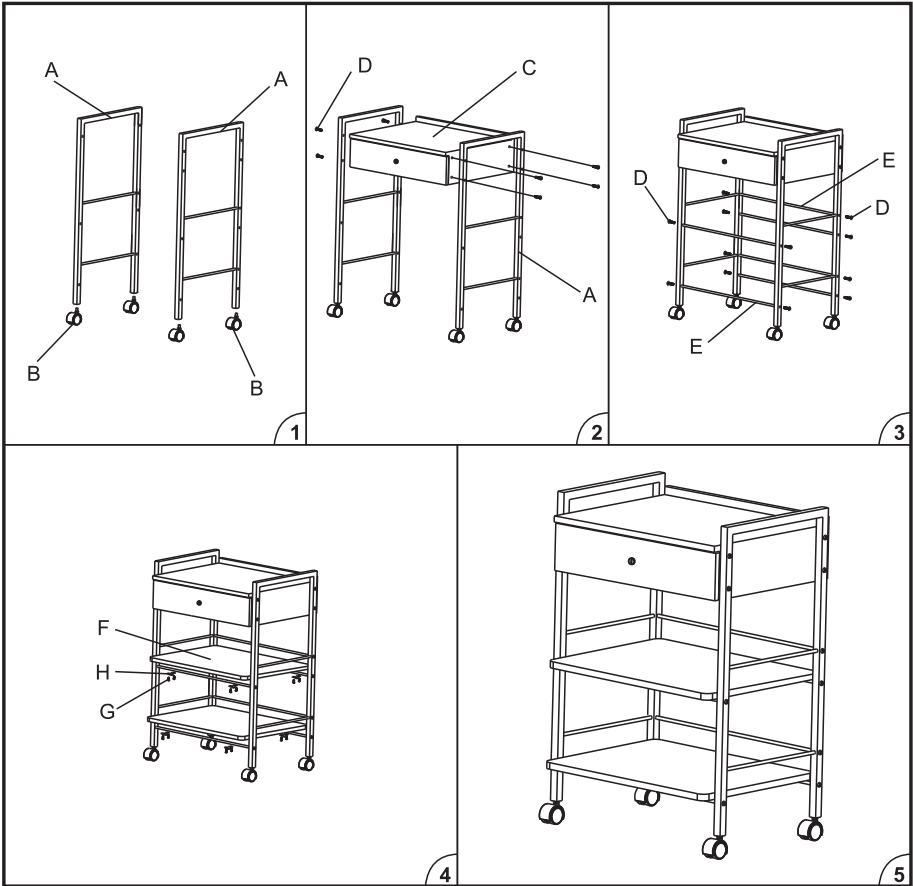

5. Specification

- N.W: 17kg
- G.W: 19kg
- Max Weight: 30kg
- Package Size: 82.5 x 55.4 x 41.9cm
- Product Size: 77 x 47.5 x 26.5cm

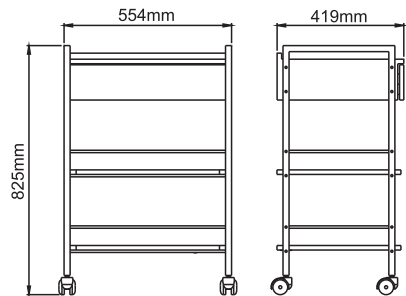

6. Maintenance

1. After every treatment, use a neutral solution to clean dust and stains.
Avoid using cleaning solutions such as alcohol, acid or alkaline solutions that could damage the surface. This is to prevent the lifetime of the components from being shortened.
2. Please lubricate the moving parts regularly (at least once a year).

7. Troubleshooting

| Fault Reference | Reason | Solution |
|----------------------|-------------------------------|--------------------|
| Not working properly | Casters cannot rotate or move | Replace the caster |

If problems continue to persist after following above operations, please contact a qualified maintenance center or your supplier to resolve.



Do not dispose of old or defective appliances in domestic garbage; this should only be done through public collection points.

- ▲ Please check the product specification before use. This manual is for reference only. Specifications are subject to change without prior notice.