



## Barneys Beauty Trolley

MODELS B81013 + B81015

User Manual

Please read this user manual carefully before using the product.

[www.barneyssalonsupplies.com.au](http://www.barneyssalonsupplies.com.au) | 1800 676 522

## 1. About This Manual

This manual should only be used in reference of the operation of this particular model. If the manual is used for other purposes, or instructions not followed correctly, Barneys Salon Supplies will not undertake any consequences or responsibility.

All information in this manual shall be protected by copyright and shall not be copied and translated in any part of this specification without the written consent of the manufacturer.

## 2. Warning

- Do not stand on the product.
- Do not allow children play with the product.
- Do not place the equipment in damp places such as bathroom or expose to direct sunlight.
- Do not use product on an unstable surface.











## 3. Precautions

- Read this manual carefully before installation, operation and adjustment.
- This product should be used by an experienced person who is familiar with the product structure and performance.
- The operator must use the product only for its intended use.
- Please operate the product strictly in accordance with the warning label stamped on it.
- Do not overload the product and ensure that the product has been correctly and safely installed.
- Tighten bolts, nuts and castors regularly to avoid product failure and to keep product secure.
- Do not operate this product if faulty. Should the product appear to behave unusually, cease using the product and inspect immediately. Do not use the product until issues have been resolved.
- Position and use equipment safely by placing on level ground.
- After every treatment, clear the dust or stains on the product using a neutral cleaning solution.

## 4. Installation

1. Place the product in a safe location, according to the overall layout of the treatment room.  
Keep it in a clean, dry and cool environment.
2. Open the packing carton and remove all parts prior to installation.
3. Ensure all parts are included and the packing carton is checked thoroughly prior to disposing.





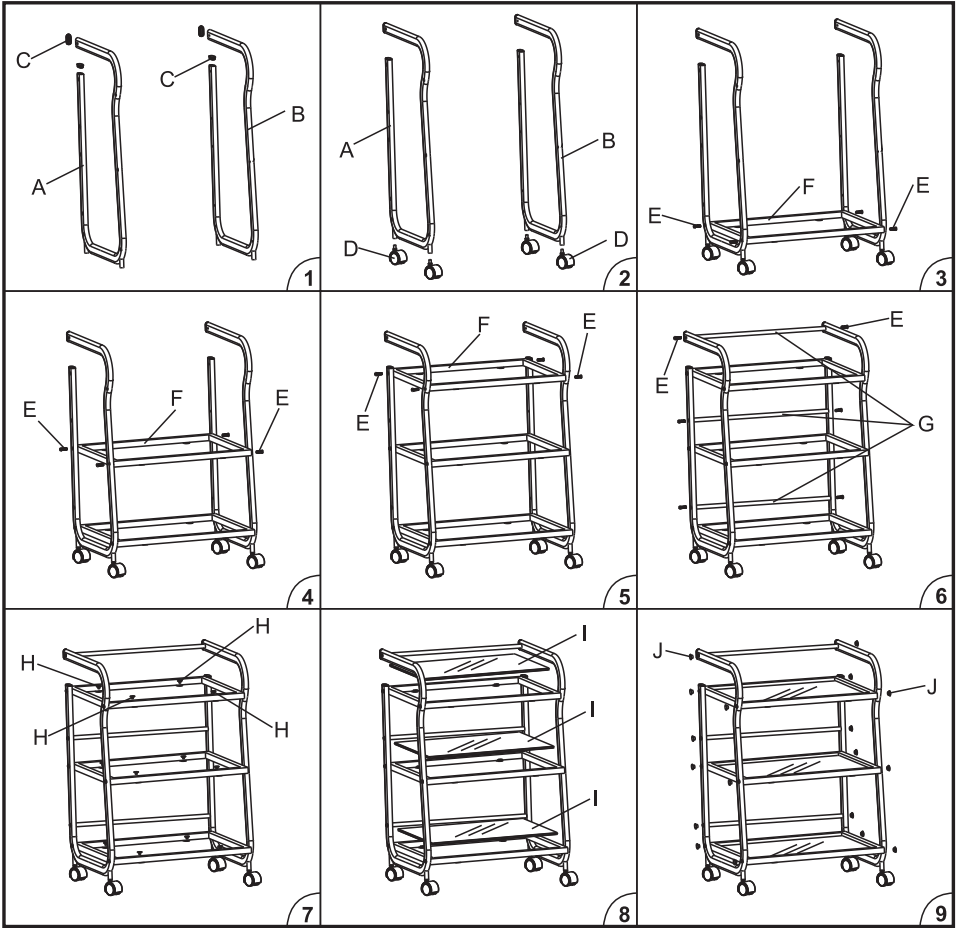

- B81013 Components List

NO.	Name	Sample	Quantity
A	Metal frame for left		1
B	Metal frame for right		1
C	Accessories-1		4
D	Wheel		4
E	Screw (M6×20)		19
F	Accessories-2		3
G	Baluster		3
H	PVC Tray		13
I	Glass		3
J	Plastic Pin		18

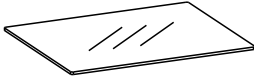
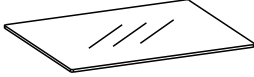
• B81013 Installation Procedure:

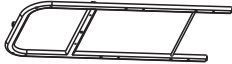
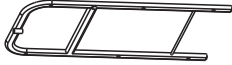

• B81015 Components List:

NO.	Name	Sample	Quantity
A	Glass 604×296		1
B	Glass 624×356		3
C	Wheel		4
D	Baluster		5
E	Metal frame for left-1		1
F	Metal frame for right-1		1
G	Accessories-1 648×340		1
H	Accessories-1 668×400		3
I	Screw (M6×20)		12
J	PVC Tray		16

● B81015 Installation Procedure:

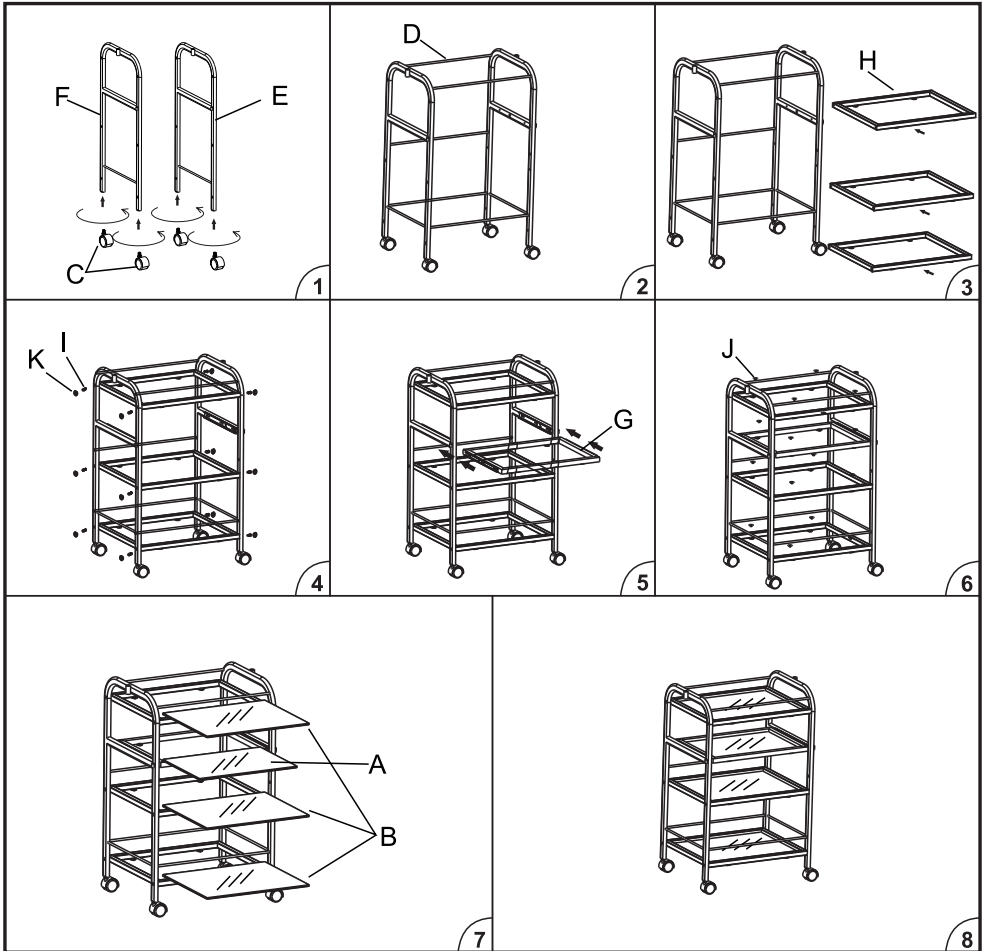

## 5. Technical Parameters:

Lifting Rated Load	30 kg
Package Size	770×455×155mm (1013) 850×440×140mm (1014) 880×430×200mm (1015A) 850×370×165mm (1017) 760×455×150mm (1040 / 1041) 995×655×175mm (1040A / 1041A)
Net Weight	14kg(1013) , 13.5kg (1014) , 22.5kg (1015A) , 5.6kg (1017) , 16kg (1040 / 1041) , 24kg (1040A / 1041A)
Gross Weight	16kg(1013) , 14.5kg (1014) , 525kg (1015A) , 6.9kg (1017) , 18.5kg (1040 / 1041) , 28.5kg (1040A / 1041A)

B81013

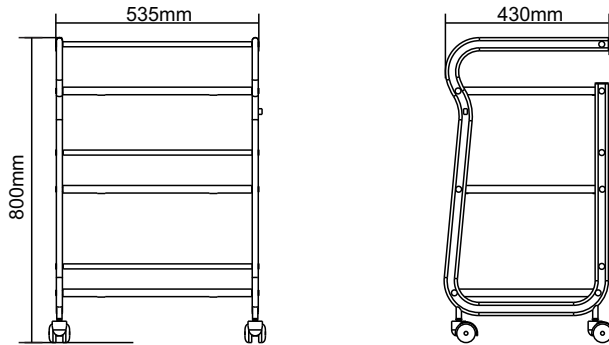

## 6. Maintenance

1. After every treatment, use a neutral solution to clean dust and stains.  
Avoid using cleaning solutions such as alcohol, acid or alkaline solutions that could damage the surface. This is to prevent the lifetime of the components from being shortened.
2. Please lubricate the moving parts regularly (at least once a year).

## 7. Troubleshooting

Fault Reference	Reason	Solution
Not working properly	Casters cannot rotate or move	Replace the caster

If problems continue to persist after following above operations, please contact a qualified maintenance center or your supplier to resolve.



Do not dispose of old or defective appliances in domestic garbage; this should only be done through public collection points.

- ▲ Please check the product specification before use. This manual is for reference only. Specifications are subject to change without prior notice.