



## 1 ROUGH-IN INSTALLATION:

Adjust the SeeLess black perforated aluminum brackets, to either 1/2", 5/8", or 3/4" line. Caddy bars are recommended for easy mounting between studs (\*not supplied by SeeLess). Verify studs are leveled, so that the platform is leveled with the drywall. Flat-headed screws are recommended (Pre-drill SeeLess brackets for rounded screws). \*Don't over screw when using a power drill to avoid cracking the gypsum.



## 2

Screw these two plates together: the Araknis metal backplate for dropped ceiling and the Araknis plastic mounting bracket.

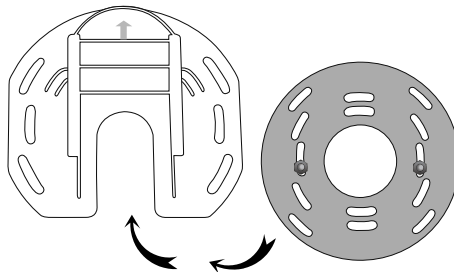

## 3

Adjust the SeeLess black perforated aluminum brackets, to either 1/2", 5/8", or 3/4" line.  
Insert SeeLess platform at an angle.

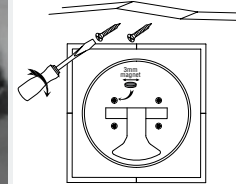
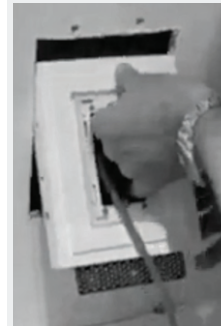

## 4

Level the drywall with the lower line of the joint on the front of the gypsum platform.



Secure SeeLess platform using flat headed drywall screws.

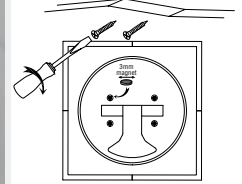

## 5

Cover the inside of the platform with paper or tape to protect the center opening. Apply the fiberglass tape on all four joints around the platform. Patch with drywall compound.

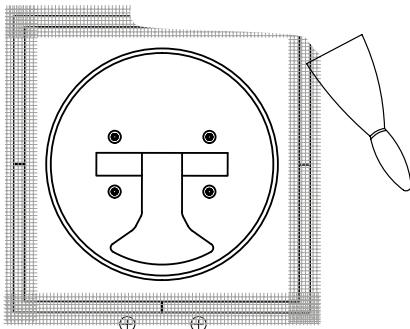

## 6

Sand surface smooth. Apply one coat of primer and wait for it to dry. Apply two coats of paint (it is recommended that you paint inside of the opening).



## 7

Install the device.



## 8

SeeLess suction cups are available to remove the device.

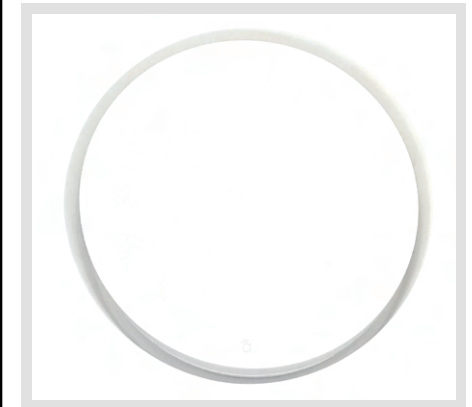

## ROUGH-IN INSTALLATION

\*Telescopic (retractable) caddy brackets and drywall screws are not included.

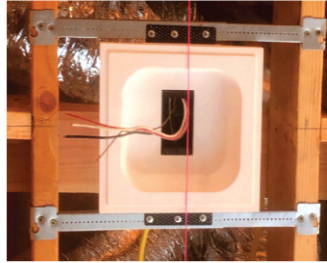

### *When mounting a SeeLess Platform:*

**1. Make sure the electrical box is centered to your gypsum platform before installing drywall. The box can be loosened and moved to center it.**

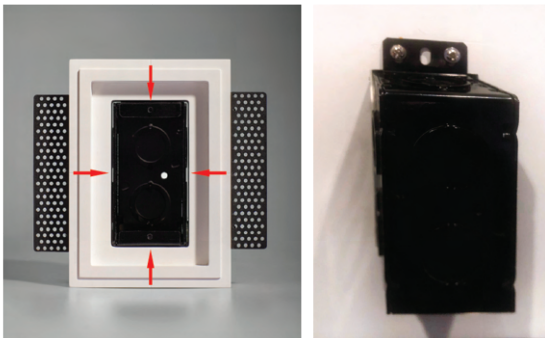

**2. Measure your desired distance between the two studs.**

**3. Caddy bars are recommended for easy mounting between studs.**



**4. Verify studs are level by using a straight-edge across the platform. Furr out each side, if necessary, so that the platform is leveled with the drywall.**

**4.**



**5. Check the thickness of drywall to be installed and adjust the SeeLess black perforated aluminum brackets, to either 1/2", 5/8", or 3/4" line (holes are perforated to the standard market perforation size)**



**6. Check the level and height of the plaster platform. Screw caddy brackets to each stud at the appropriate height.**



7. Line up and screw the black perforated brackets on the SeeLess platform to the caddy crossbars. **\*Don't over screw when using a power drill to avoid cracking the gypsum. We recommend using two flat-headed screws.**



8. If you are using rounded screws, predrilling the brackets is recommended.

9. Put straightedge across studs and flush out the outer edge of the plaster box to it, then check the level.

10. Gypsum has center lines marked on each side of the platform to help with laser marker alignment.

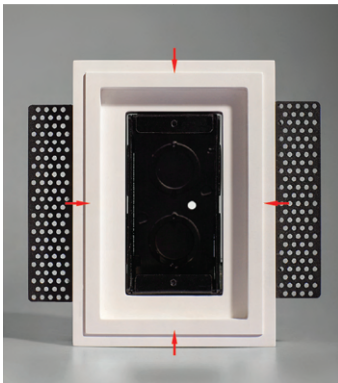

11. For knockout and wiring, press on the soft pre-punched 1/2" and 3/4" knockouts on the junction box. **Re-check the electrical box to ensure it is centered with the gypsum platform after wiring.**

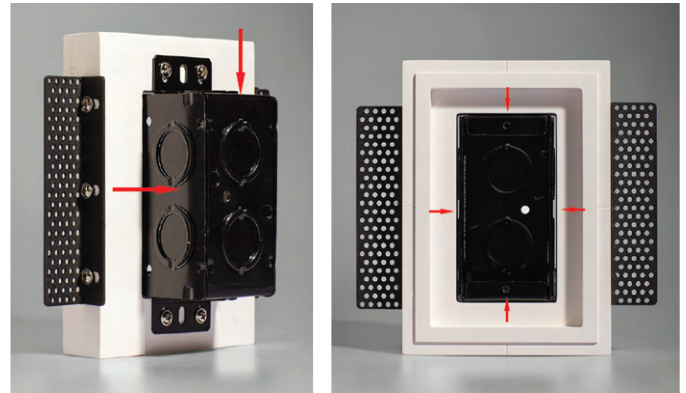

\*For post-install instructions refer to Post Install Drywall Instructions document.





## **POST INSTALL DRYWALL INSTRUCTIONS**

\*Drywall screws are not included

*When mounting a SeeLess Platform:*

**1. Cut in drywall around the platform.**

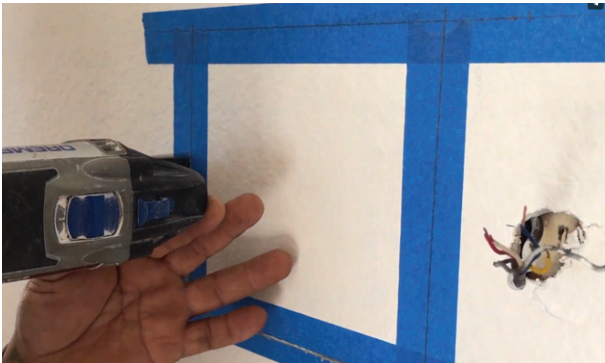

**2. Level the drywall with the lower line of the joint on the front of the gypsum platform.**

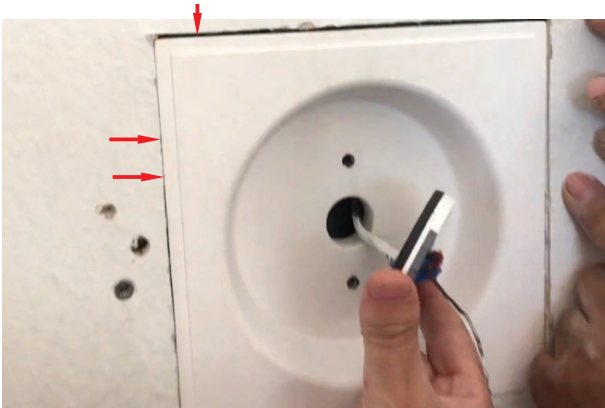

**3. Make sure that the laser center markers are evenly centered on all sides along the drywall.**

**4. Cover the inside of the platform with paper or tape to protect the center opening.**

**5. Apply the fiberglass tape on all four joints around the platform.**

**5.**

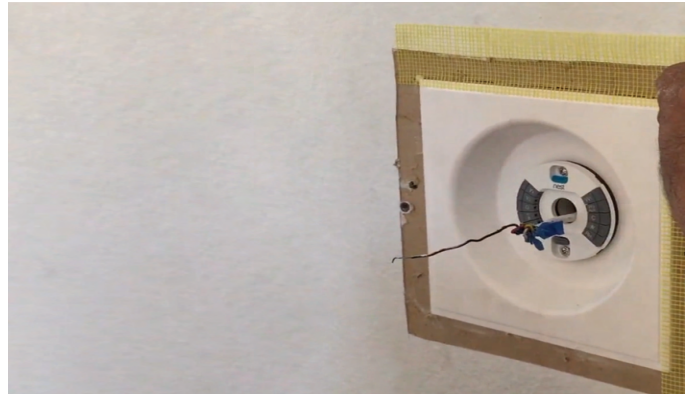

**6. We recommend using the Fast Set Lite 20 (or 40 depending on available time).**

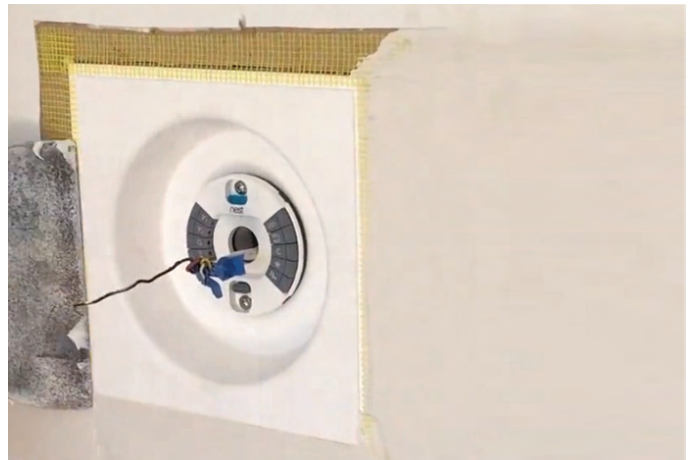

**7. The recommended joint compound to use is the Green Dot topping by Westpac Materials.**



**8. Once the first layer of the mud dries, sand-down with 120 grit sandpaper. When the second layer of mud dries, we recommend using 200-grit sandpaper. Then, when the third layer of mud dries, use 220 grit sandpaper.**



**9. Apply one coat of primer and wait for it to dry.**

**10. Apply two coats of paint. (it is recommended that you paint inside of the opening)**



## ROUGH-IN INSTALLATION

\*Telescopic (retractable) caddy brackets and drywall screws are not included.

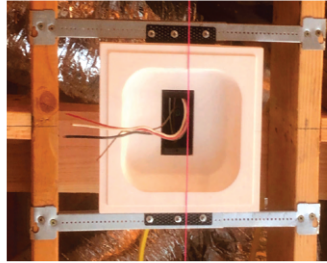

### *When mounting a SeeLess Platform:*

**1. Make sure the electrical box is centered to your gypsum platform before installing drywall. The box can be loosened and moved to center it.**

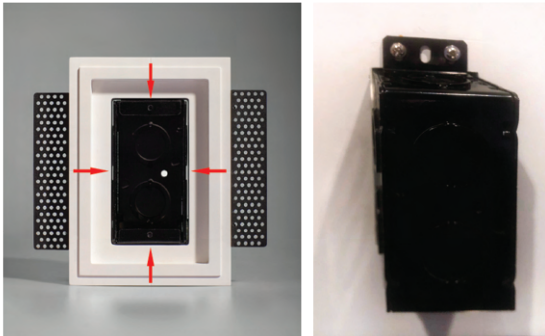

**2. Measure your desired distance between the two studs.**

**3. Caddy bars are recommended for easy mounting between studs.**



**4. Verify studs are level by using a straight-edge across the platform. Furr out each side, if necessary, so that the platform is leveled with the drywall.**

**4.**



**5. Check the thickness of drywall to be installed and adjust the SeeLess black perforated aluminum brackets, to either 1/2", 5/8", or 3/4" line (holes are perforated to the standard market perforation size)**



**6. Check the level and height of the plaster platform. Screw caddy brackets to each stud at the appropriate height.**





7. Line up and screw the black perforated brackets on the SeeLess platform to the caddy crossbars. **\*Don't over screw when using a power drill to avoid cracking the gypsum. We recommend using two flat-headed screws.**



8. If you are using rounded screws, predrilling the brackets is recommended.

9. Put straightedge across studs and flush out the outer edge of the plaster box to it, then check the level.

10. Gypsum has center lines marked on each side of the platform to help with laser marker alignment.

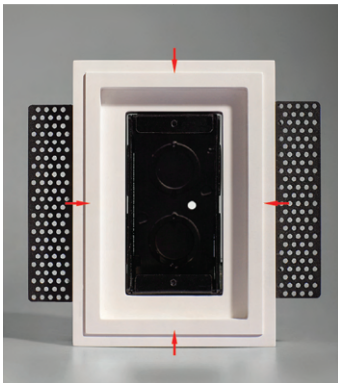

11. For knockout and wiring, press on the soft pre-punched 1/2" and 3/4" knockouts on the junction box. **Re-check the electrical box to ensure it is centered with the gypsum platform after wiring.**

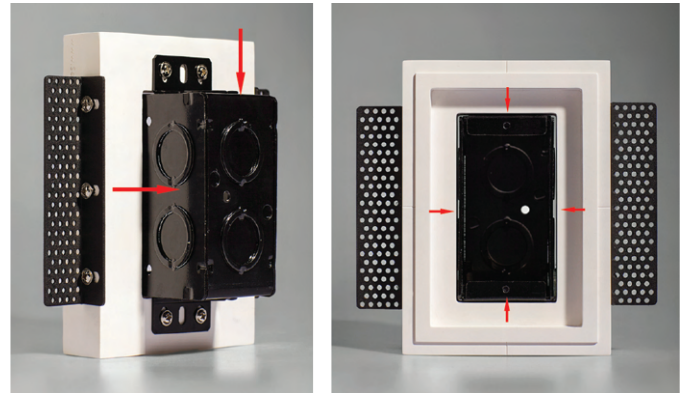

\*For post-install instructions refer to Post Install Drywall Instructions document.



## POST INSTALL DRYWALL INSTRUCTIONS

\*Drywall screws are not included

*When mounting a SeeLess Platform:*

**1. Cut in drywall around the platform.**

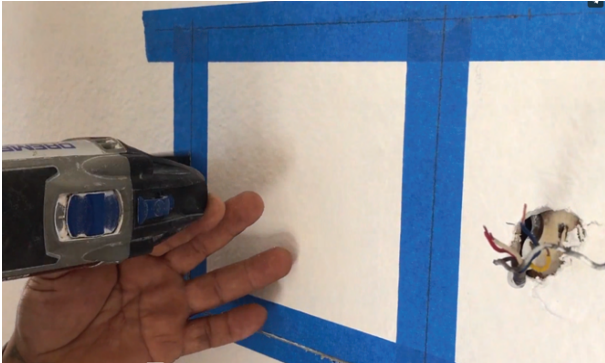

**2. Level the drywall with the lower line of the joint on the front of the gypsum platform.**

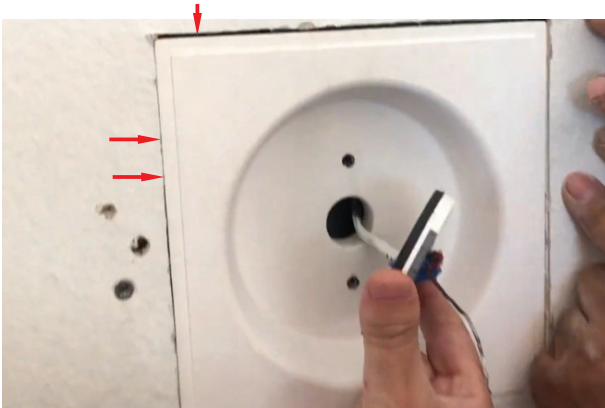

**3. Make sure that the laser center markers are evenly centered on all sides along the drywall.**

**4. Cover the inside of the platform with paper or tape to protect the center opening.**

**5. Apply the fiberglass tape on all four joints around the platform.**

**5.**

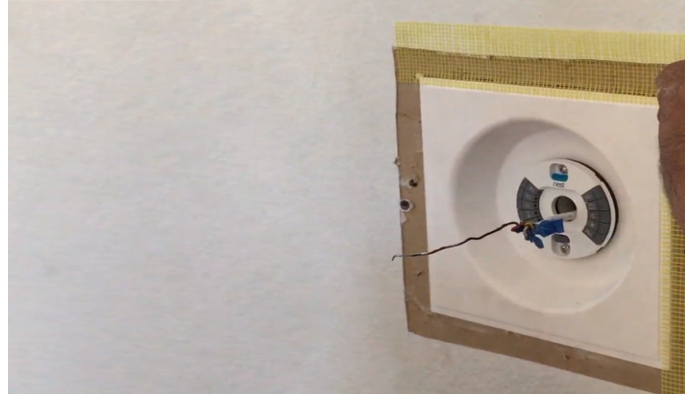

**6. We recommend using the Fast Set Lite 20 (or 40 depending on available time).**

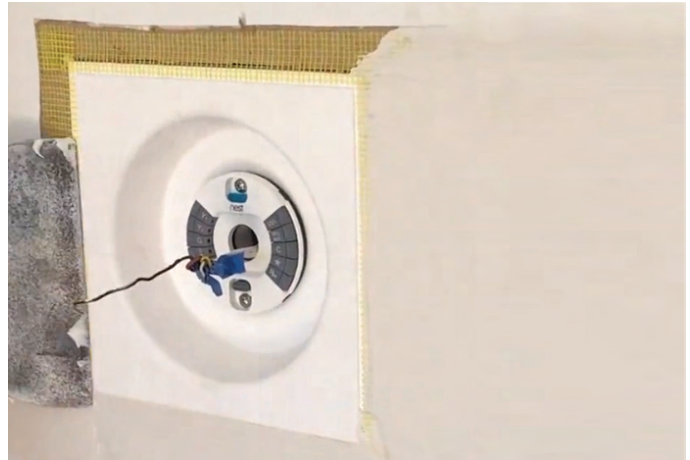

**7. The recommended joint compound to use is the Green Dot topping by Westpac Materials.**





**8. Once the first layer of the mud dries, sand-down with 120 grit sandpaper. When the second layer of mud dries, we recommend using 200-grit sandpaper. Then, when the third layer of mud dries, use 220 grit sandpaper.**



**9. Apply one coat of primer and wait for it to dry.**

**10. Apply two coats of paint. (it is recommended that you paint inside of the opening)**

