



Manual

BC281 Model

Contents

- **Product Description and Specifications.....3**
 - Parts Description3
- **Function introduction4**
 - Features.....4
 - Buttons Functions5
- **Operation5**
 - Power on/off5
 - Cycling interface6
 - Assist level switch7
 - Error Code7
 - User Menu.....8
 - **Advanced Settings**12
 - Connect to APP (only for Bluetooth version)13
- **EUNORAU App User Manual14**
- **Attentions16**

■ Product Description and Specifications



DTK3 Button



BC281 Display

● Parts Description

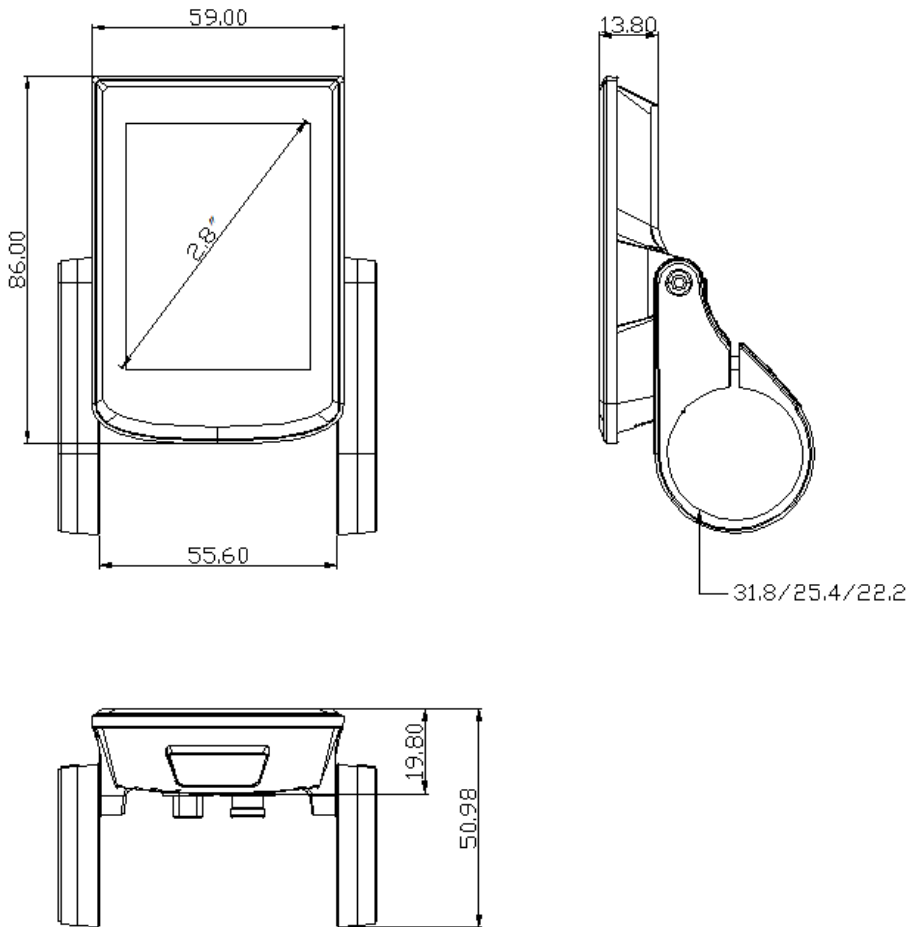

Display Dimensions

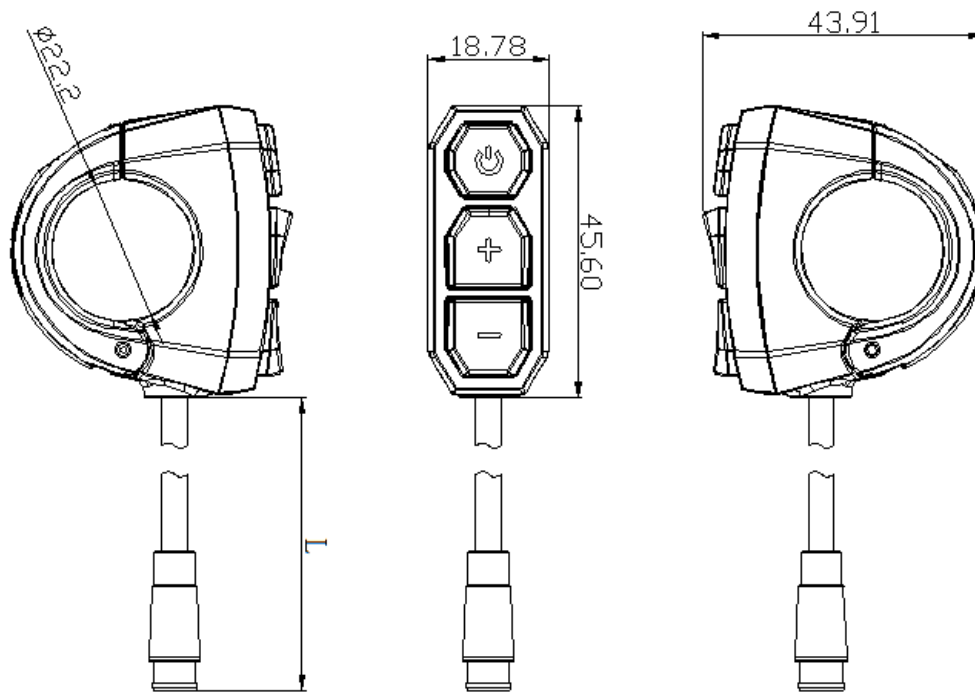

DTK3 Button Dimensions

■ Function introduction

● Features



BC281 provides the display function of common riding data and statistical results, as well as some practical functions:

- ◆ Real-time speed, Max speed, Average speed
- ◆ Real time motor power
- ◆ Battery indicator
- ◆ Assistant level
- ◆ Odometer, trip
- ◆ Trip time
- ◆ Calorie consumption
- ◆ Light indicator
- ◆ Metric(km/h)/Imperial(mph) switching
- ◆ Error code indicator
- ◆ Auto headlights, Brightness adjustment, automatic backlight
- ◆ Auto Power-off
- ◆ USB Port (5V/500mA)

In addition, the Bluetooth version also supports the following functions:

- ◆ APP connection
- ◆ Data synchronization
- ◆ Cycling ranking
- ◆ Cycling track record

● Buttons Functions

Buttons	Name	Functions
	[Power]	1、 Power on/off 2、 Setting confirmation
	[+]	1、 Parameter adjustment 2、 Menu operation
	[-]	1、 Parameter adjustment 2、 Pedestrian mode on/off 3、 Menu operation

■ Operation

● Power on/off

In the off state, long press the [Power] button to enter the boot logo interface, and enter the riding interface after 1.5s:

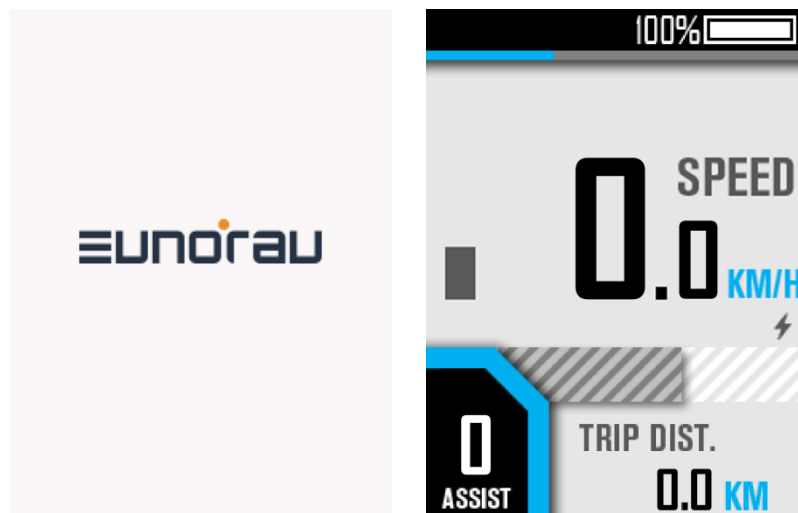

In any interface of startup, long press the [Power] button to enter the shutdown logo interface, and shut down after 2s:

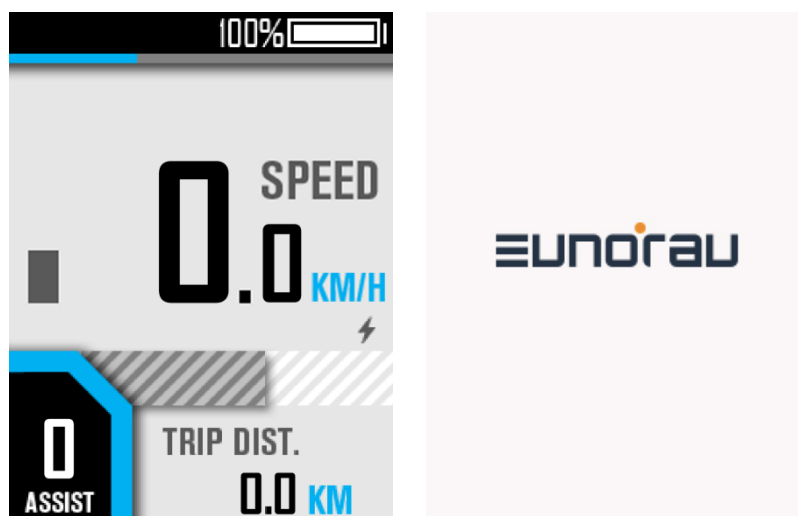

● Cycling interface

BC281 provides various styles of riding interface, you can switch the display by clicking the [Power] button:

1. Simple mode

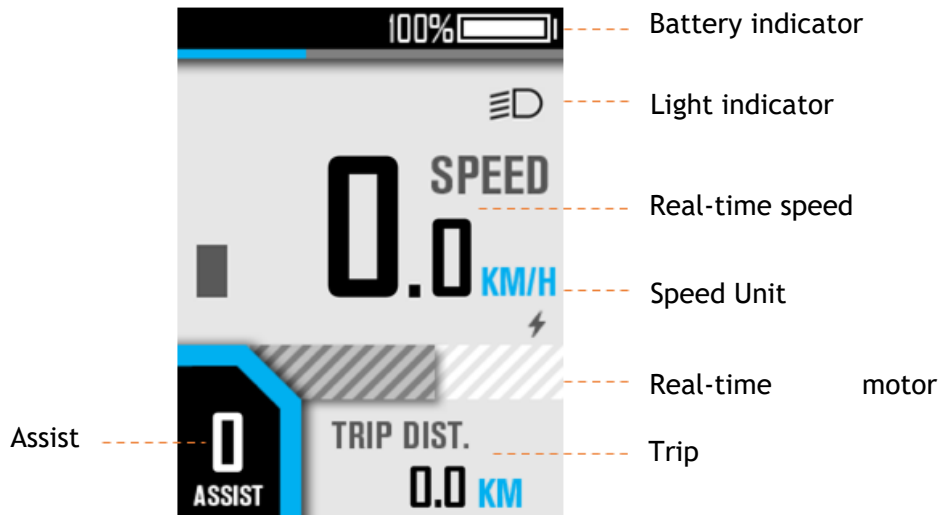

2. Sports Mode

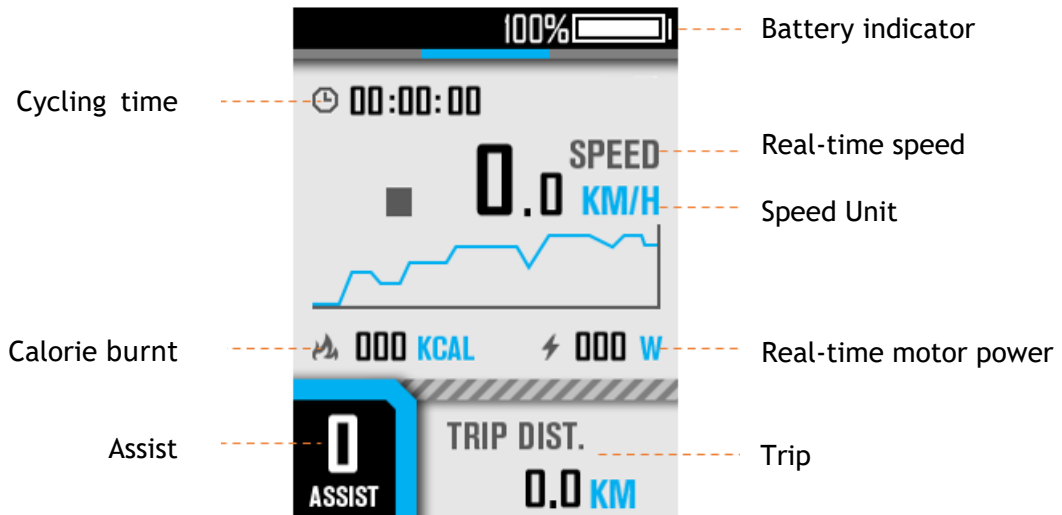

3. Statistical Mode

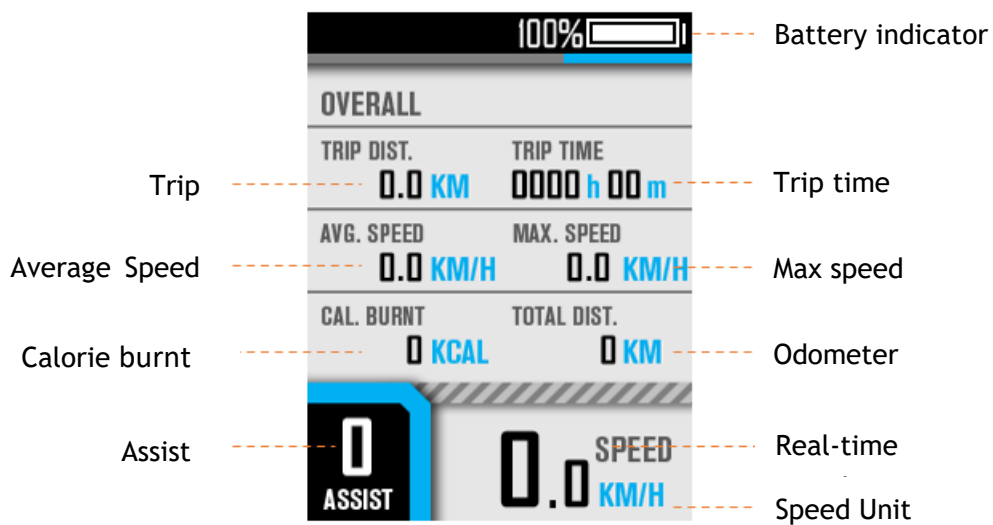

● Assist level switch

Click [+] / [-] to switch assist levels;

Press and hold the [-] button to activate the boost mode, and release the [-] button to exit the pedestrian mode.

● Error Code

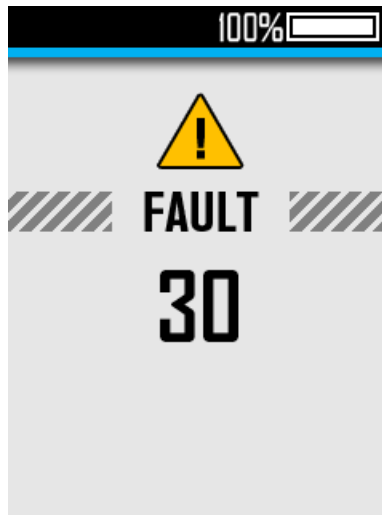

Common error codes (error codes are related to other accessories of the ebike, the following information is for reference only):

Protocol Error Code

Error Code	Meaning
04	Throttle pull not back
05	Throttle Error
07	High-voltage protection
08	Motor Hall Error
09	Motor Phase Error
10	Controller temperature protection
11	Motor temperature protection
12	Current sensor Error
13	Battery temperature protection
14	Motor temperature sensor Error
21	Speed sensor Error
22	BMS communication Error
23	Light Error
24	Light sensor Error
25	Torque sensor signal Error
26	Torque sensor speed Error

● User Menu

In the static state, long press the [+] and [-] combination button for 2s on the cycling interface to enter the user menu interface.

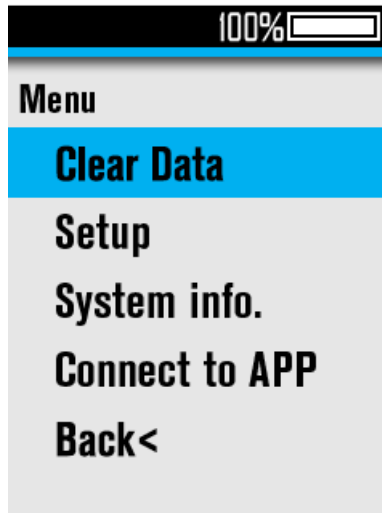

To ensure user safety, the user menu can only be accessed when the ebike is stationary (speed 0). In this interface, you can switch the submenu by clicking the [+] / [-], and click the [Power] to enter the selected submenu interface.

1、 Clear Data

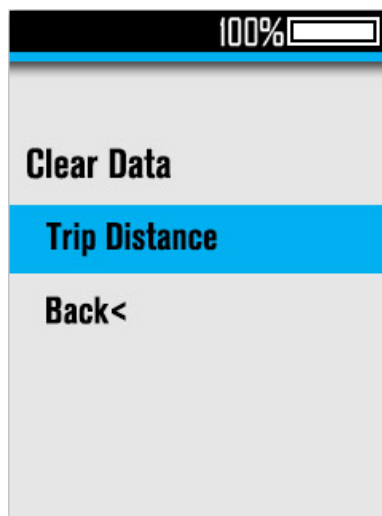

(1) Clear Trip Data

Select "Trip Distance", click the [Power] button, select Yes according to the interface prompts and click the [Power] button again to confirm, you can clear the single mileage:

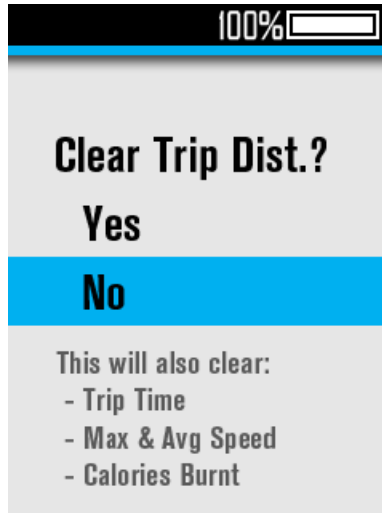

[Note] Clearing Trip Dist will also clear the Trip time, average speed, ma speed, and calories burnt.

2、 Setup

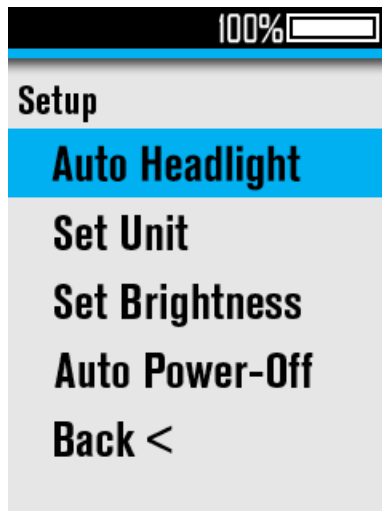

(1) Auto Headlight

Select Auto Headlight submenu and click the [Power] button to enter, you can set whether to enable the automatic headlight function:



(2) Set Unit

Select Set Unit and click the [Power] button to enter, you can select the speed unit:

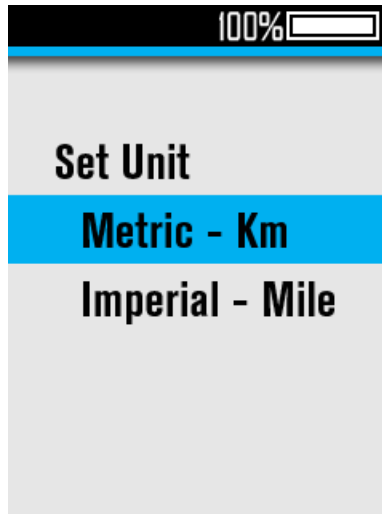

(3) Set Brightness

Select Set Brightness and click the [Power] button to enter, you can use the [+] / [-] to adjust the backlight brightness level, the adjustment range is 0-5:



(4) Set Auto Power-Off

Select Auto Power-Off and click the [Power] button to enter. You can use the [+] / [-] to adjust the automatic power off time. The adjustment range is 0-99, unit: minutes. When set to 0, it means to cancel the automatic power off:

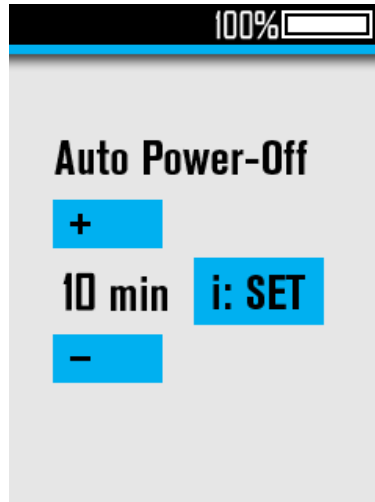

3、 Check System Info.

Enter System Info, to view system information:

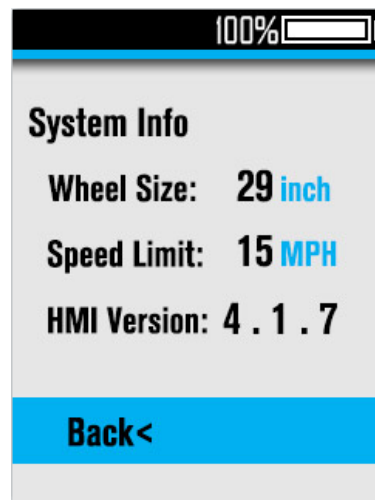

● **Advanced Settings**

Long press [Power] button for 6 seconds to enter the interface and then input the password 1919 to the functions setting.

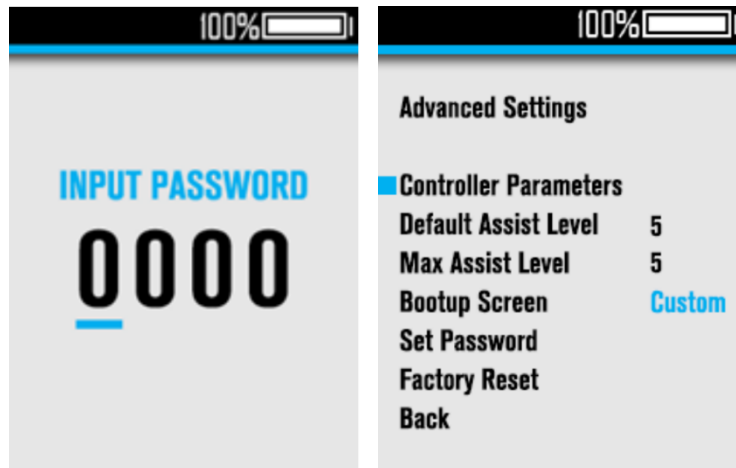

Enter Controller Parameters to set Wheel diameter/Voltage/ Speed Limit via adjusting **【+】** / **【-】** button and press [Power] to enter the function.

1、 Wheel diameter

Choose the wheel diameter as your need from range 16/18/20/22/24/26/27.5/28 and press [Power] to save the function.

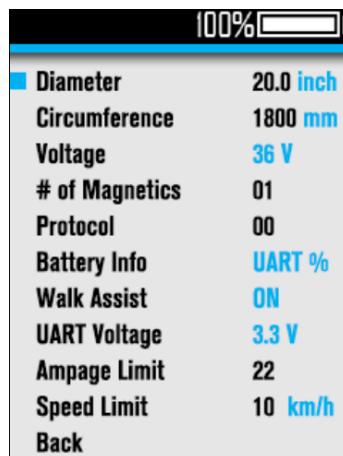

2、 Voltage

Choose 36V/48V/52V as your need and press [Power] to save the function.

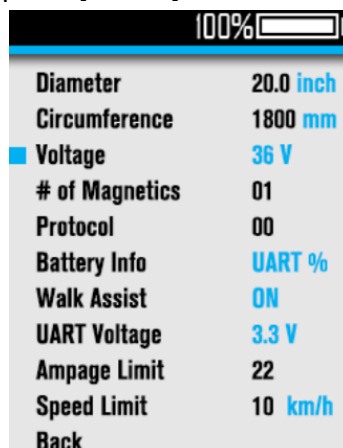

3、 Speed limit

Set the speed limit as your need and press [Power] to save the function.

100% 	
Diameter	20.0 inch
Circumference	1800 mm
Voltage	36 V
# of Magnetics	01
Protocol	00
Battery Info	UART %
Walk Assist	ON
UART Voltage	3.3 V
Ampage Limit	22
Speed Limit	10 km/h
Back	

4、 Other function settings , same way to above. All done, press [Power] 1 seconds to shut off and restart.

● Connect to APP (only for Bluetooth version)

- 1、 Scan the following QR code to download the APP: or search keywords “EUNORAU/EUNORAU GO/EUNORAU EBIKE” in your APP STORE or GOOGLE PLAY.

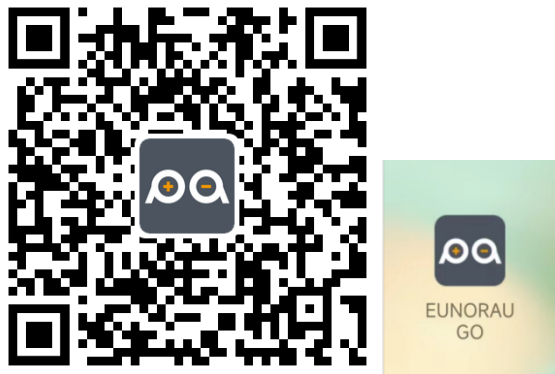

- 2、 Select Connect to APP in the user menu, get the Bluetooth connection QR code, and scan it with the APP to pair:

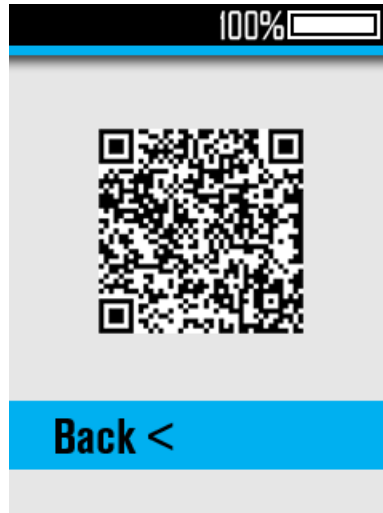

EUNORAU App Using Manual

1, After connecting by Bluetooth, choose the model you need to pair.

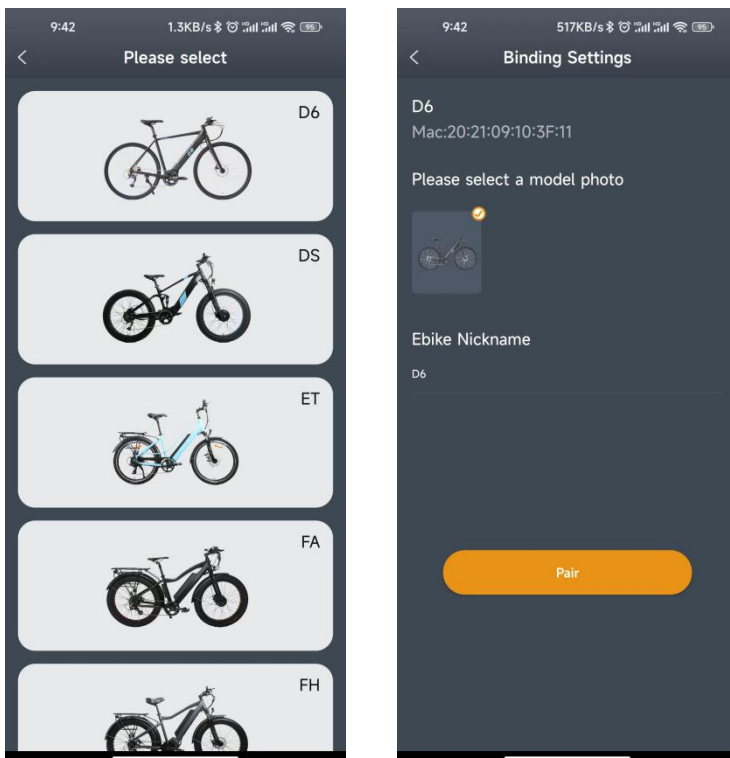

2, Enter this page, you can see the Bluetooth status. Also some function settings and the riding data show here.

A. You can set some function, e.g. Headlights off/on, Unit Switch and Gear adjustment.

B. In the further setting, you can set Ebike Nickname/Screen Brightness/Auto Power/Speed Limit /Wheel Diameter/Unlock Code/Unpair/Lock Fuction.

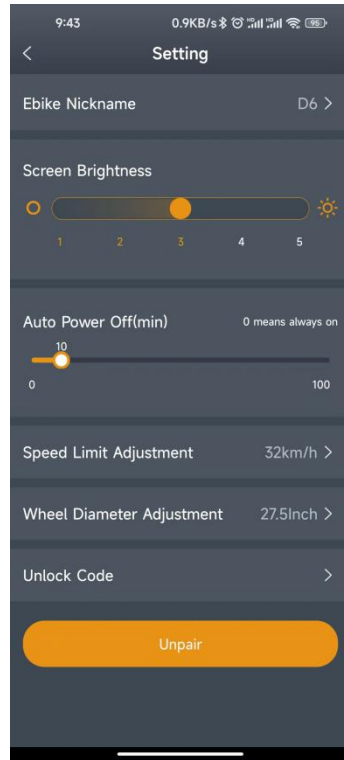
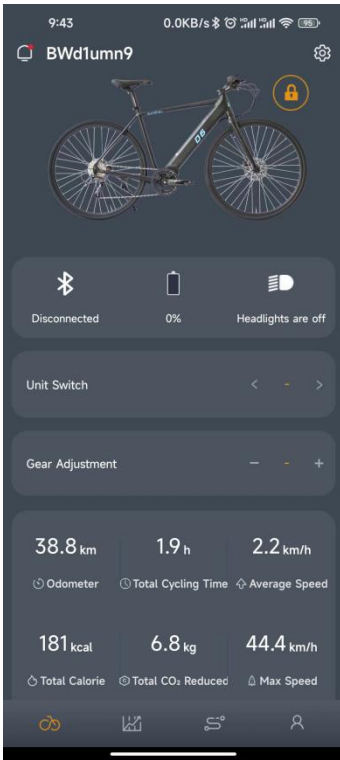

C. When click the lock icon “lock on” as below show, you can lock and unlock the display. After Bluetooth is off, you need input the password once power on. The initial password is 0000. You can set your password in the app.

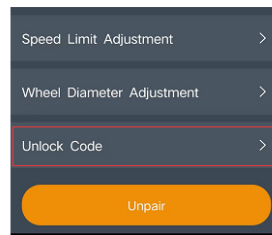
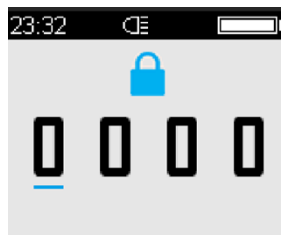
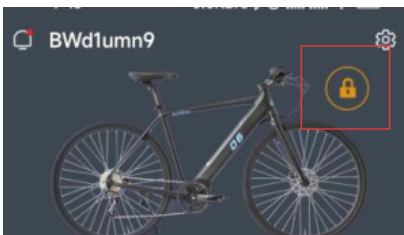

3, Enter Riding Status page

A. Click “Start” , start the riding

B. Click “Pause”, pause the riding. If continue the riding, click “Continue”, otherwise touch “Destroy”, end the riding.

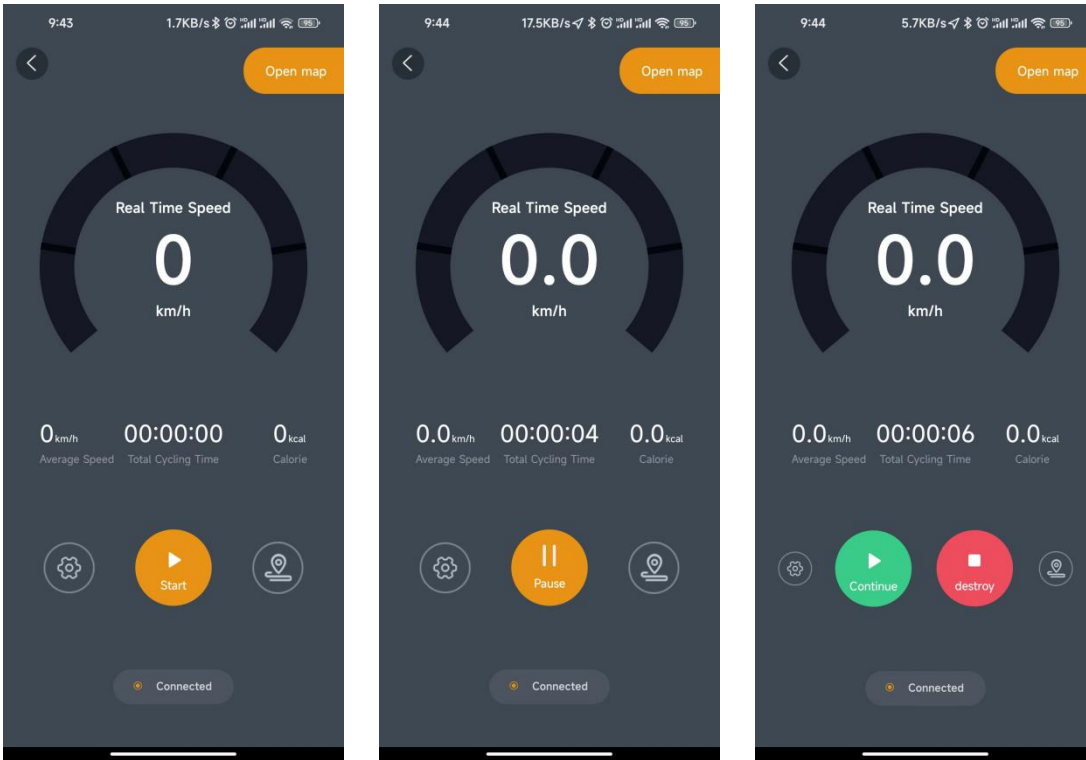

■ Attentions

1. Before plugging and unplugging the display, be sure to turn off the power first, as live plugging and unplugging will cause permanent electrical damage to the display;
2. When installing the display, please ensure that the torque value of the hexagon socket head cap screw is 0.2Nm (maximum does not exceed 0.6Nm). Excessive torque will cause damage to the instrument structure;
3. Do not immerse the display in water;
4. When cleaning the display, use a soft cloth dipped in clean water to wipe the surface, but do not use any cleaning agent or spray liquid on the surface;
5. When cleaning the instrument, use a soft cloth dipped in clean water to wipe the surface, but do not use any cleaning agent or spray liquid on the surface;
6. Please abide by local laws and regulations when scrapping, discard or recycle in an environmentally friendly way, and do not discard the instrument or any accessories as resident waste;
7. The damage and failure of the instrument caused by improper installation or use are not covered by the after-sale warranty.
8. Please contact info@eunorau-ebike.com for inquiries and after-sales services.