



# User Manual

## BC182 Series

Version: CH-V0.2

## Table of contents

■ <b>Appearance and Size</b> .....	<b>3</b>
● Size Specification.....	3
■ <b>Features Introduction</b> .....	<b>4</b>
● Features & Parameters.....	4
● Button Description.....	4
■ <b>Operation</b> .....	<b>5</b>
● Power on/off.....	5
● Cycling Interface .....	5
● Gears Shifts.....	6
● Turn on/off lights.....	6
● Reset Trip Range .....	6
● Error Display .....	6
● User Menu .....	7
● OTA upgrade (Bluetooth Version Only).....	9
■ <b>Advanced Menu</b> .....	<b>10</b>
● Enter Advanced Menu.....	10
● Wheel Diameter.....	10
● Speed Sensor .....	10
● Battery Voltage Setting .....	11
● Exit .....	11
■ <b>EUNORAU App Using Manual</b> .....	<b>12</b>
■ <b>Attentions</b> .....	<b>13</b>

## ■ Appearance and Size



Display Appearance Drawing

### ● Size Specification

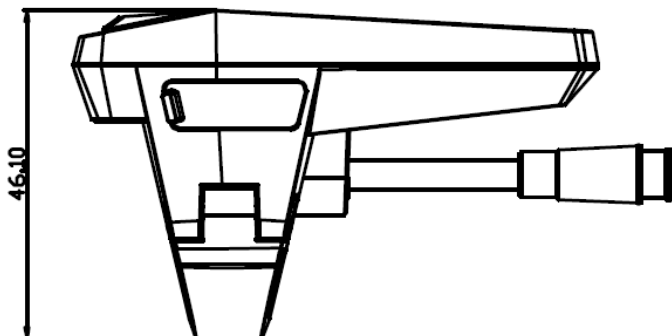
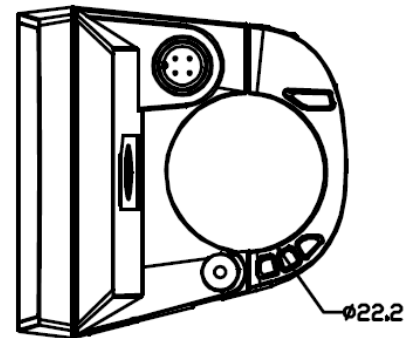
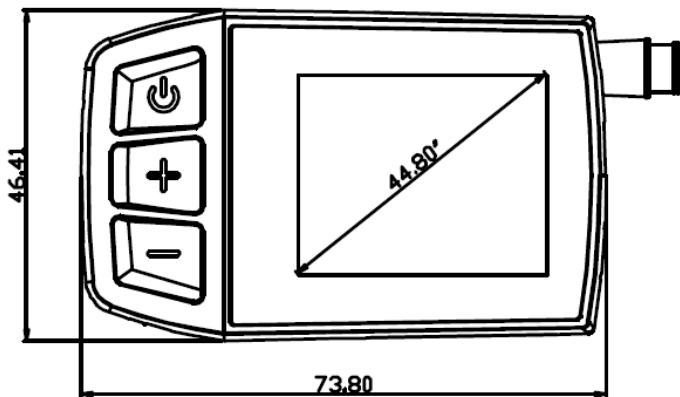

Display Size Specification

## ■ Features Introduction

### ● Features & Parameters



BC182 offers display function about common cycling data and statistical result, as well as some practical functions.

- ◆ Current Speed, Max Speed, Average Speed
- ◆ Current Motor Power
- ◆ Battery Level
- ◆ Assist Gears
- ◆ Total Range, Trip Range
- ◆ Trip Time
- ◆ Calorie Consumption
- ◆ Light Indicator
- ◆ Metric (km/h)/British (mph) Unit Shifts.
- ◆ Error Code
- ◆ Backlight Adjustment
- ◆ Auto Power off Time
- ◆ USB Port (5V/1000mA)

In addition, the Bluetooth version supports the following features:

- ◆ APP connection
- ◆ Data Synchronization
- ◆ Cycling Ranking
- ◆ Riding Track Records

### ● Button Description

Button	Name	Function
	[Power]	1、 Power on/off 2、 Function Confirmation
	[+]	1、 Parameter Adjustment 2、 Light on/off 3、 Menu Operation
	[-]	1、 Parameter Adjustment 2、 Push Assist Starts/Shuts 3、 Menu Operation

## ■ Operation

### ● Power on/off

Under power off status, long press [Power] to enter logo interface with power-on interface after 1s and cycling interface after 2s.



In any working interfaces, long press [Power] to switch off.

### ● Cycling Interface

The cycling interface supports multiple parameters display:

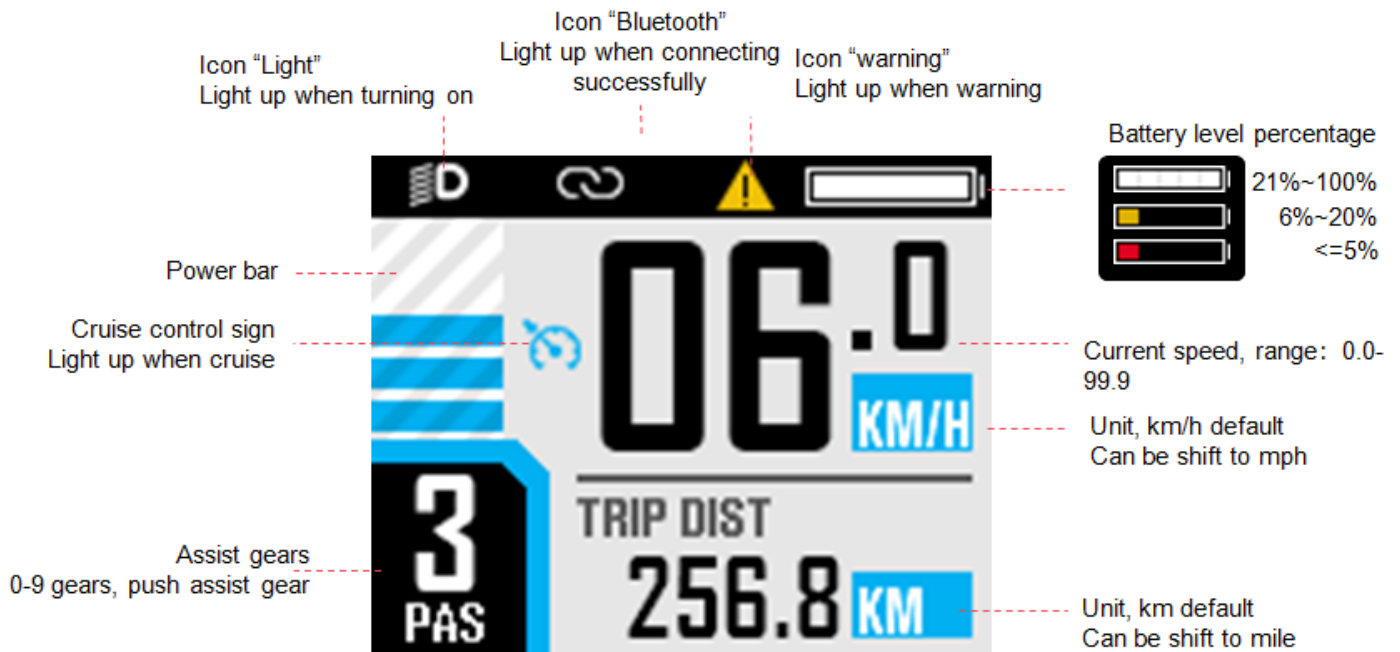

Short press "Power" to switch to display area (the interface is saved for power cutoff, see attachment for specific parameters.)

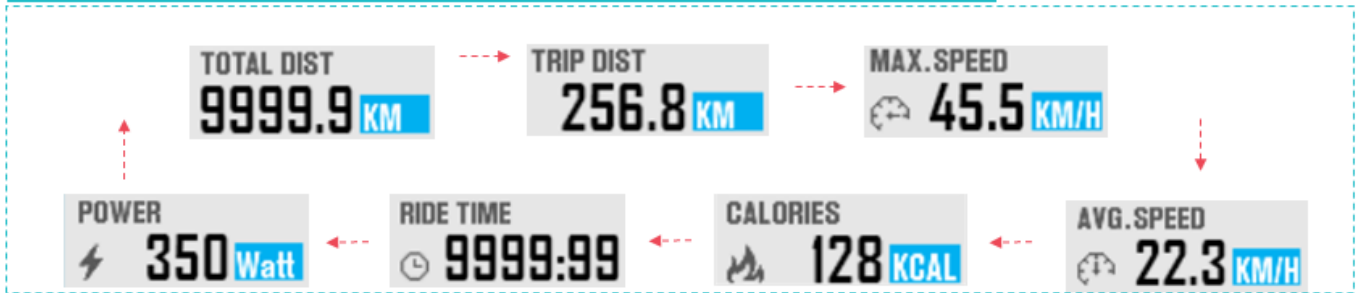

● Gears Shifts

Click on [+] / [-] button to shift gears;

Long press [-] for 2S to start 6km/h push assist mode and release [-] to exit push assist mode.

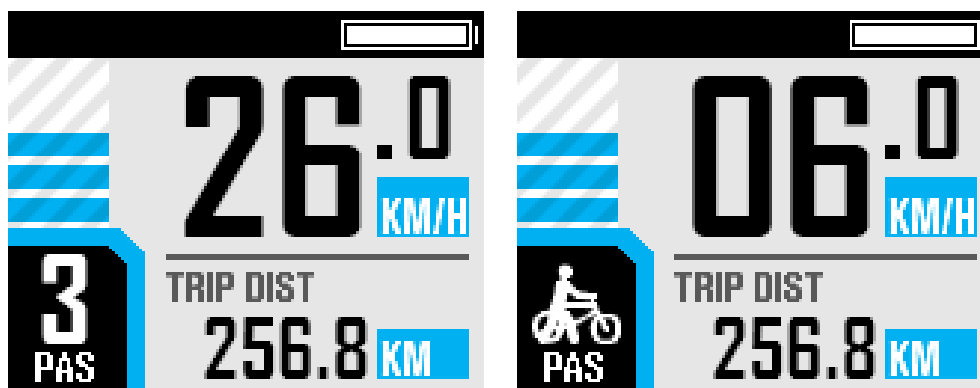

● Turn on/off lights

Long press [+] for 2s to turn on/off the lights during E-bike is running.

● Reset Trip Range

Long press [Power] and [+] synchronously to reset the trip range:

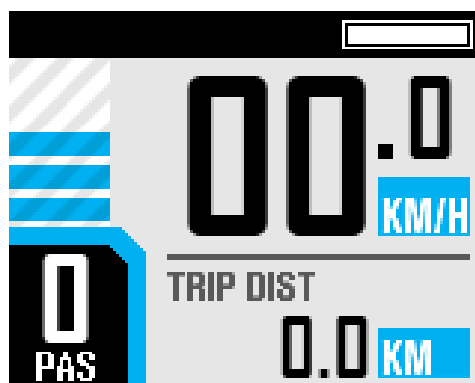

。 Note: For the Bluetooth version, the max speed, average speed, the total trip time and calories can be reset synchronously.

● Error Display

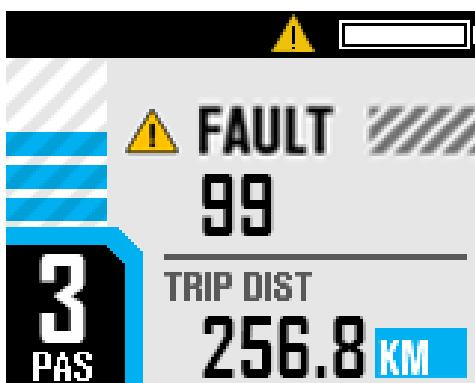

Common Error Codes (the error codes are related with E-bike’s fitting part (please refer to the information below):

### Protocol Error Code

Error Code	Meaning
04	Throttle pull not back
05	Throttle Error
07	High-voltage protection
08	Motor Hall Error
09	Motor Phase Error
10	Controller temperature protection
11	Motor temperature protection
12	Current sensor Error
13	Battery temperature protection
14	Motor temperature sensor Error
21	Speed sensor Error
22	BMS communication Error
23	Light Error
24	Light sensor Error
25	Torque sensor signal Error
26	Torque sensor speed Error

#### ● User Menu

In a static and fault-free state, long press [+] and [-] or 1s synchronously to enter the user menu interface. The speed limits, data unit, auto power-off time and backlight brightness can be set up. The Bluetooth connection can be set in menu with Bluetooth version.

If the interface doesn’t operate for 60s, system will return Riding interface automatically.

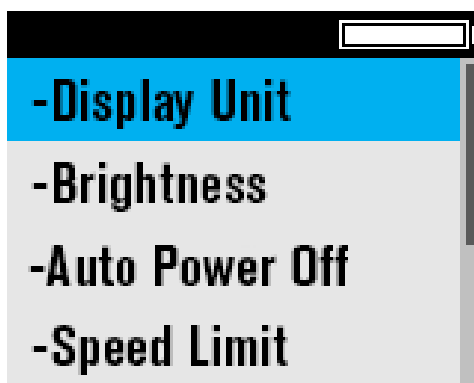

### 1、 Unit Setting

Selecting menu “Set Unit”, click on [+] / [-] to shift unit. Click on [Power]to confirm and save, then shift to “OK” interface, it returns to setting menu interface automatically after 2s standstill.

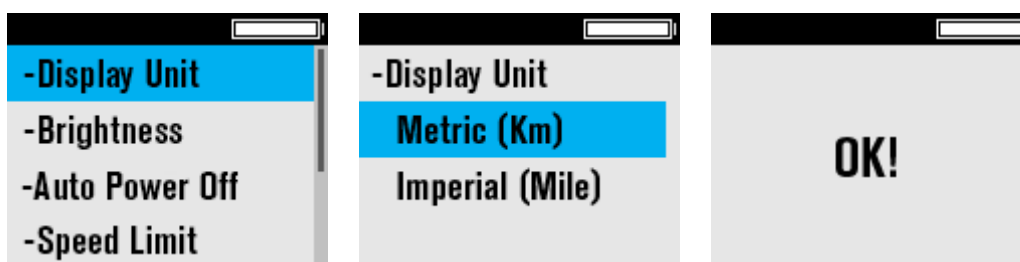

### 2、 Backlight Brightness setting

Selecting menu “Brightness”, click on [+] / [-] to shift brightness setting, the adjustment range is Auto 1-5.

Clicking on [Power] to confirm and save, then shift to “OK” interface, it returns to setting menu automatically after 2s standstill.

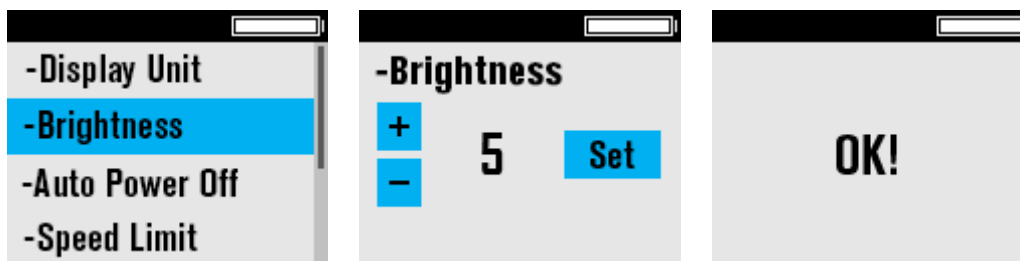

### 3、 Auto Power-off Time

Selecting menu “Set Auto Off”, click on [+] / [-] to shift auto power off time, the adjustment range is 0-99 (in minute). 0 is switch off the function of auto power off.

Clicking on [Power] to confirm and save, then shift to “OK” interface, it returns to setting menu automatically after 2s standstill.

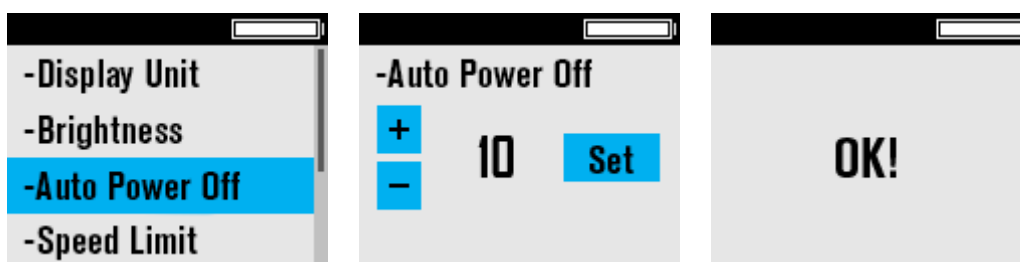

### 4、 Speed Limits Adjustment

Selecting menu “Speed Limit”, click on [+] / [-] to adjust speed limiting, the range is 12-



40km/h. Please note that speed limiting and setting unit keep synchronized, which can shift to mph.

Clicking on [Power] to confirm and save, then shift to “OK” interface, it returns to setting menu automatically after 2s standstill.

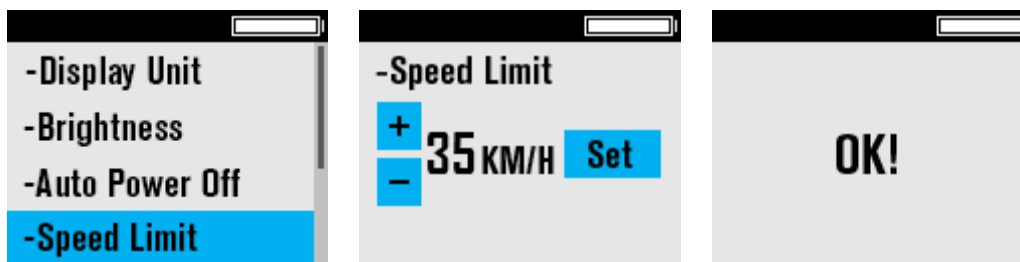

### 5、Bluetooth connection setting

User can search - “EUNORAU GO” in your App Store or Google Play, or scan the following QR code to download the mobile app.



To connect the display for the first time, it need choose “Connect To APP” in menu, scan QR code by APP to bind E-bike. After operation is finished successfully, the icon “Bluetooth” stops flickering but lights constantly.



### ● OTA upgrade (Bluetooth Version Only)

After APP is linked, OTA upgraded will activate display to be in OTA upgraded status. Shut down and reboot after OTA upgraded is finished.

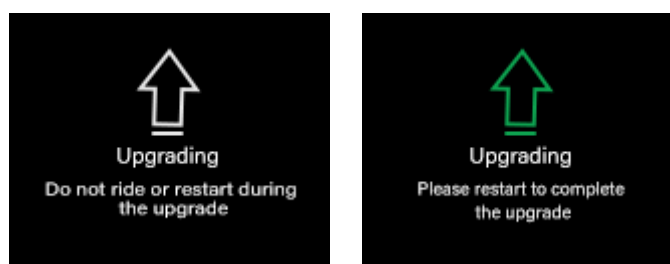

Upgrading

Finished

## ■ Advanced Menu

BC182 provides advanced menu for E-bike manufacturer, which could adjust the E-bike configuration and the following parameters:

- ◆ Wheel Diameter
  - ◆ Battery Voltage
  - ◆ Speed Sensor
- Enter Advanced Menu

When the display is in a shutdown status, long press [Power] for 6s, it runs and the advanced menu interface displays



Click on [ + ]/[ - ] to adjust flickering parts and click on [Power] to change flickering part or confirm the login. and then input the **password 1919**.

\*If password input is wrong, the 1<sup>st</sup> number will flicker again, user can readjust each digit.

- Wheel Diameter

Select “Wheel Diameter” and click on [ + ]/[ - ] to adjust wheel diameter digit (in Inch), adjustment range: 16/18/20/22/24/26/27.5/28/700C.

Clicking on [Power] to confirm and save, then shift to “OK” interface, it returns to setting menu automatically after 2s standstill.

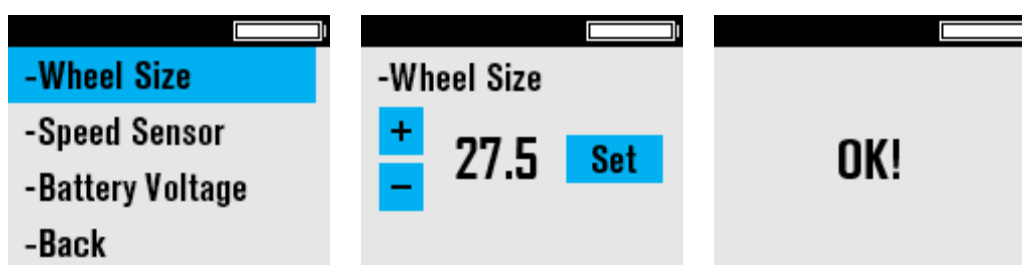

- Speed Sensor

Select menu “Speed Sensor”, click on [ + ]/[ - ] to adjust digit, adjustment range: 1-12.

Clicking on [Power] to confirm and save, then shift to “OK” interface, it returns to setting menu automatically after 2s standstill.

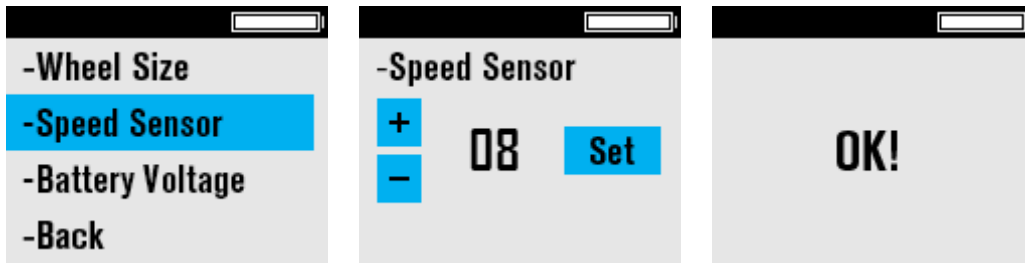

● Battery Voltage Setting

Select menu “Battery Voltage”, click on [+]/[-]to shift battery voltage (in volt), the range: 36V/48V/52V, click on [Power]to confirm and save, then switch to next interface.

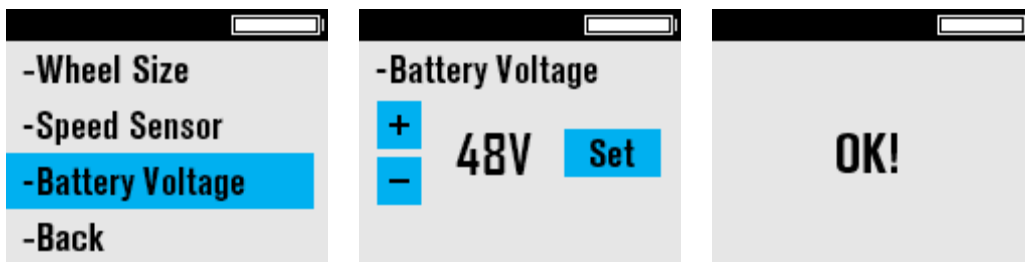

● Exit

1. If there's no operation for 60s in any working interface, system enters Riding interface automatically.
2. Long press [Power] for one second in any working interface, system shuts down.

## EUNORAU APP USING MANUAL

1, After connecting by Bluetooth, choose the model you need to pair.

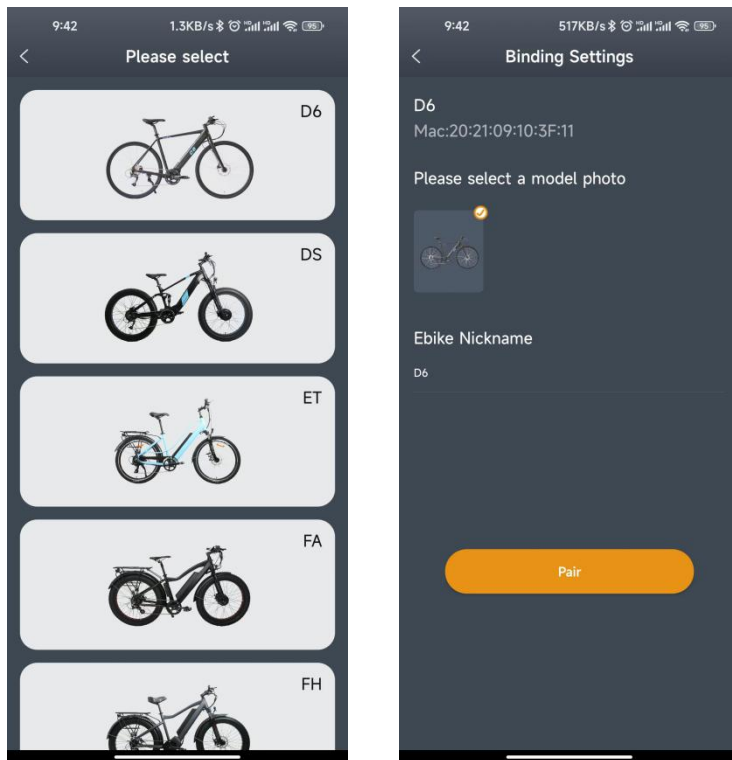

2, Enter this page, you can see the Bluetooth status. Also some function settings and the riding data show here.

A. You can set some function, e.g. Headlights off/on, Unit Switch and Gear adjustment.

B. In the further setting, you can set Ebike Nickname/Screen Brightness/Auto Power/Speed Limit /Wheel Diameter/Unlock Code/Unpair/Lock Function.

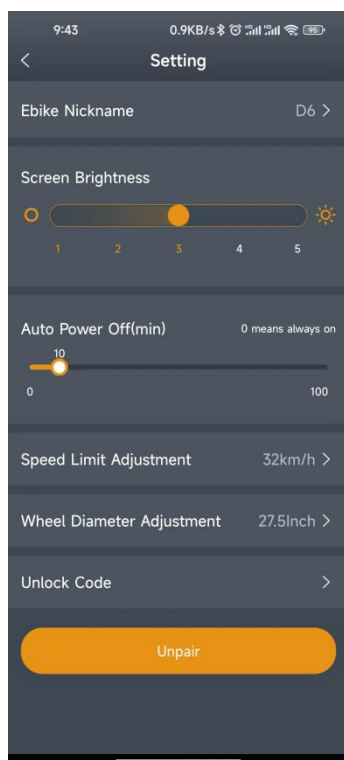
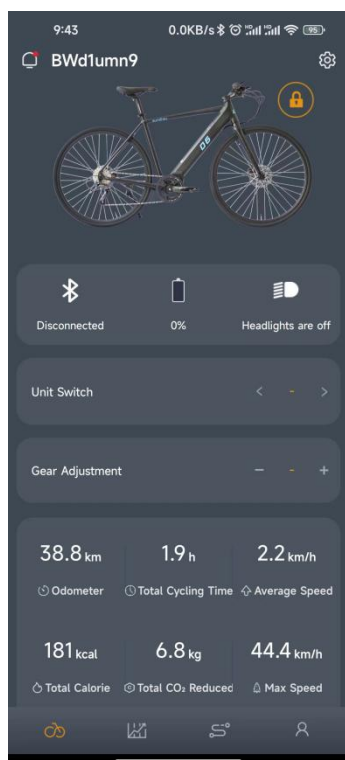

C. When click the lock icon “lock on” as below show, you can lock and unlock the display. After Bluetooth is off, you need input the password once power on. The initial password is 0000. You can set your password in the app.

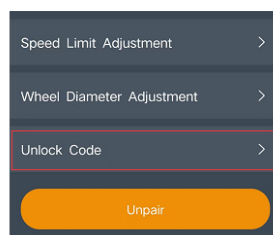
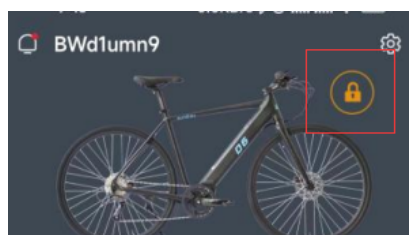

### 3, Enter Riding Status page

A. Click “Start” , start the riding

B. Click “Pause”, pause the riding. If continue the riding, click “Continue”, otherwise touch “Destroy”, end the riding.

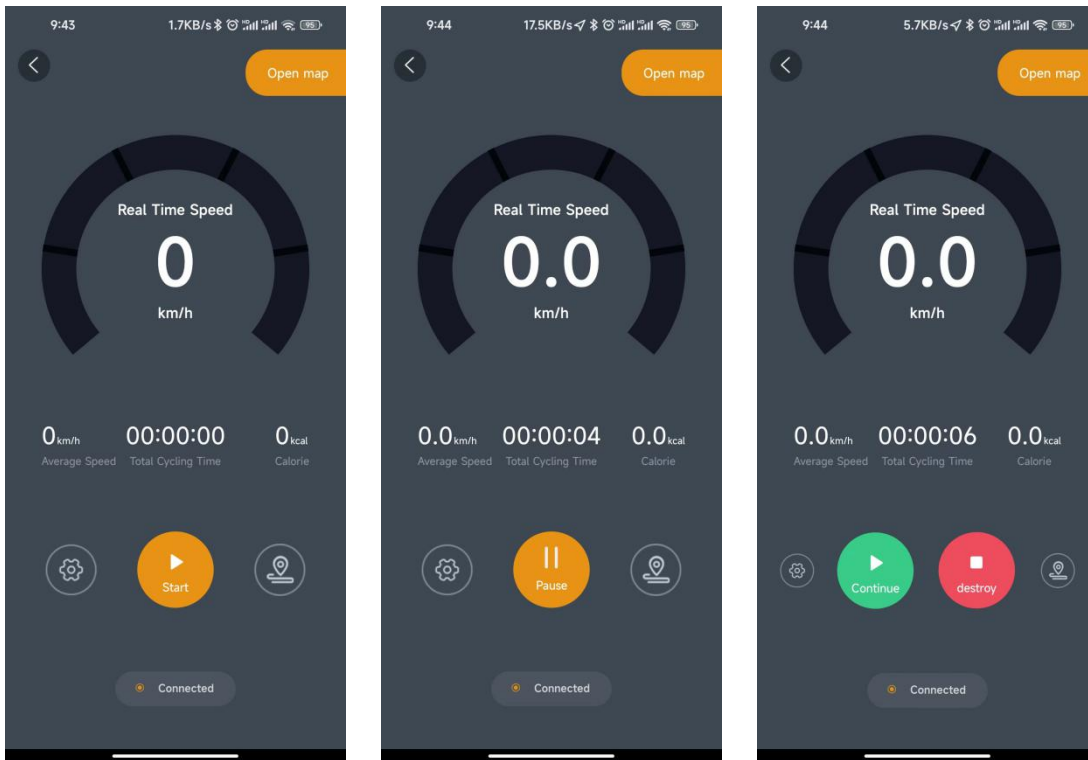

## ■ Attentions

1. Please make sure to turn off the power before the device is connected, otherwise it causes device damaged permanently;
2. Please make sure to fix the inner hexagon screws with maximum torsion value less than 1Nm, otherwise it causes device damaged;
3. The device is not permitted to soak in water;

4. Please use soft wet cloth to wipe the surface and clean the device, DO NOT use or spray any chemical liquid;
5. The USB port of display is NOT waterproof. Please ensure the protective rubber plug is tucked tightly during riding in the rain. It's forbidden to connect external devices in the rain;
6. Please scrap the device abide by local laws and regulations, discard or recycle in any eco-friendly way. Please do not discard device or any accessories as domestic garbage;
7. Improper installation, human damage and failure are not covered by the after-sale warranty;
8. Please contact [info@eunorau-ebike.com](mailto:info@eunorau-ebike.com) for pre-sale and after-sale matters.