

puik

CREATING
new
originals.

2020 / 2021

CREATING NEW ORIGINALS

Now's the time for a new beginning,
for a fresh take on Dutch design. We
returned to the essence and found
a boundless source of inspiration
in primary shapes and colors.
Monumental elements, which alone
can lift entire spaces to a new level, are
recomposed into bold silhouettes.

We create new originals.

puik (Dutch adjective, adverb)
1
best, excellent





Puik

TIMELESS

It's important to make a good and sustainable product. You fall in love with it when you first see it, and each time you use it, it evokes something. Because you love it you tend to it for years to come, eventually replacing the fabric and finally passing it on to your kids. That's the essence of good design.

ORIGINAL

By narrowing it down to its very essence, puik reimagines Dutch design. The remaining monumental elements are recomposed into new originals, forming an ever-growing collection by Dutch design's finest.

MONUMENTAL

Design has a transformative quality: it can lift up a space and render it extraordinary. Iconic 'wow' items can excite instantly and are remembered forever.

CRITICAL

Good design is only excellent when it's good for all parties involved, including our planet. High standards should be non-negotiable, so puik sets the bar high and keeps its footprint low.

FURNITURE



Dost collection

BY RIANNE KOENS

This inviting, cosy collection has been designed to provide a sense of solace and safety. Named for the native word meaning 'friendship', the Dost lounge chair was inspired by one of our most basic human needs: comfort.











Chester collection

BY LEX POTT

One of the most iconic archetypes: the Chesterfield. The classic sofa is reinvented by stripping it of its details and minimising it to a contemporary, sculptural sofa.







Optum

BY RIANNE KOENS

The Optum chair is the answer to the best shape for ultimate comfort. The luxuriously soft seating folds together with the backrest, as two lips that meet for a kiss.







Option collection

BY FREDERIK ROIJE

Inspired by primary forms, a playful line of chairs was created with just two simple shapes. Uniting circles and squares in a geometric marriage. With these items, there's more than meets the eye, as every new combination of chairs feels fresh and different.













Bokk

BY KA-LAI CHAN

Add a nostalgic nod to any room with Bokk: a contemporary stool inspired by classic school gym equipment. Designed to be tough on the outside and soft on the inside, the frame forms an interesting geometric play of lines.





Fold

BY BAS VELLEKOOP

Practical yet pleasing to behold, the Fold table incorporates a solid oak top and a 'folded' steel base. The frame consists of eight individual parts that have been folded together, origami-style, resulting in elegant joints and an impressive finish.





Shunan

BY NIEUWE HEREN

Bring the outside in with Shunan, our round metal and wood coffee table. It's curved ash top is supported by strong, vertical steel legs, creating an organic and elegant feel. The table represents a perfect marriage of classic simplicity and present-day flair.





Hinge

BY LEX POTT

The Hinge side table vocalises the beauty in simplicity. The starting point was the traditional hinge: two interlocking metal plates connected by a rod. As the functional is made ornamental, the Hinge side table is subtly expressive and allows for a unique landscape of design pieces.





Bonnett

BY LEX POTT

The elegant design allows you to guide the light yourself: as the magnetic lampshade firmly sticks to the lightbulb, you can change its position just as easy as rearranging a hat.





Cone

BY KRANEN/GILLE

Pure form leads the way in this classic and timeless design. Designed by combining shapes and sizes the core of its design was reached. This resulted in the Cone light, with as its focal point a glass cylinder emerging from that one perfect shape.





Groove

BY ILIAS ERNST

Elevate the style of any room with this classic yet current design. The Groove ceiling light is a casual twist on the traditional pendant light. Hang multiple Grooves in different sizes for a high impact style or let its simple lines and laidback elegance be the focal point on its own.





Lloyd

BY NIEUWE HEREN

Lighten the mood with Lloyd, our buttery leather lamp shade that brings a new dimension to modern settings. Handmade using a traditional method for hardening and moulding hides, each individual leather lamp is finished with a bold stitch down the side.





Duplex

BY FREDERIK ROIJE

Taking the familiar and giving it a twist, this contemporary storage system is a subtle play of primary shapes. These two-sided, switchable wall shelves can be hung top-down or bottom-up, meaning you can create a thoroughly modern shelf design that is unique.

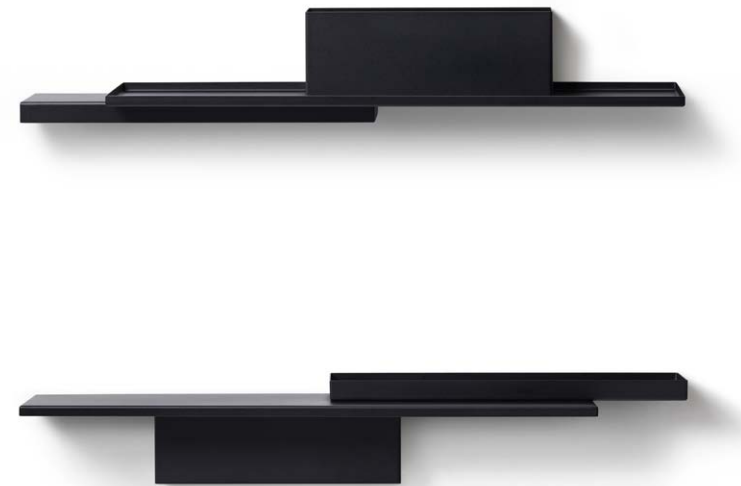



Iso

BY ONTWERPDUO

Designed using the principles of isometric perspective, this designer rug will entice you to look twice as you work out whether the shape is two-dimensional or three. The thick, soft pile will warm your floor whilst making a stand-out statement.





Facett

BY LEX POTT

An innovative design that combines faceted glass and three-dimensional shapes, these full length mirrors provide a perfect bridge between classic and contemporary styles.



ACCESSORIES



Rare, Radiant & Lucent

BY LARA VAN DER LUGT

Elevate the dining experience with our diamond shaped collection. The intentional interplay of glass, liquid and light immediately draws the eye and creates a perfect centrepiece for your dinner table.







Clork

BY ILIAS ERNST

An unusual clock that is both practical and pleasing to the eye. The combination of cork and white metal creates an exciting contrast, whilst the clever composition balances style with stability.





Boeien

BY KA-LAI CHAN

Boeien is no ordinary salt and pepper set. Beautifully constructed from cork and glass, each shaker has a convex bottom that creates a slight tilt when it is placed on a surface. The end result is dynamic and playful.





Monday vase

BY SIEBRING/ZOETMULDER

The vase is created by hand to give you the best quality for your beautiful flowers. Its soft edges will ensure you that the base will be easy to handle. Whilst the see-through glass will display your flowers in the best way.





Monday mug

BY SIEBRING/ZOETMULDER

The soft outside makes the Monday Cup comfortable to hold, while the shiny inside allows the coffee to flow elegantly.





Ply

BY ISABEL QUIROGA

The candle does not need to be lit for the Ply candle holder to command your attention. It exudes understated elegance thanks to the use of modern materials terrazzo and gold steel and its architectural composition.





Sico

BY CECILIA VALENTINE

The Sico silicone coasters make the most mundane of tasks memorable. This set of four coasters is geometric in design, and can be interlocked to safeguard a more substantial surface area whilst creating a playful pattern that is pleasing to the eye.





Loop

BY LEX POTT

This minimalist hanger is made from one piece of plated steel. The soft edges have been designed to store your favourite fashion with style, whilst the efficient circular centre provides additional hanging space for accessories.

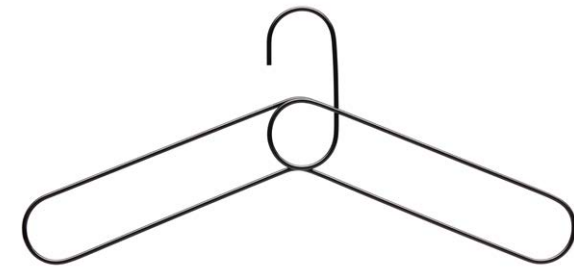



Hat

BY ILIAS ERNST

Chill your favorite wine in style with the Hat wine cooler. Our design elevates EPP to new heights, creating a bold statement piece out of a material that is traditionally known for function rather than form.





Conic

BY ISABEL QUIROGA

Combining the smooth finish of concrete with an eye-catching metallic spring, our candle holder gives an industrial touch to your interior. Customise your concrete by inserting a candle of any colour and snapping it in place with the black or gold steel spring.





Plus

BY ONTWERPDUO

Take your furnishings further with Plus, a cushion that adds both comfort and creativity to your home. By adding a secret seam to the corners, the pillow then pops out, transforming a flat piece of fabric into a three-dimensional cushion that will sit cosily on your couch.





Tammy

BY PUIK

Keep your coins safe with Tammy, our paint your own piggy bank made entirely out of paper pulp. When she's full, you can recreate the timeless tradition of breaking apart your bank - without any waste.





Silly

BY BASTIAAN HEMMES

Designed with versatility in mind, these playful products can hold both tea lights and larger candles: simply flip the holder and enjoy! With a simple, timeless design and bags of character, a Silly candleholder will light up your space in more ways than one.



SPECIFICATIONS

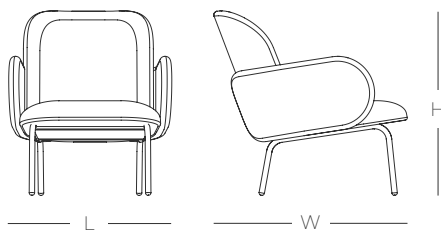

DOST lounge chair

DESIGNED BY RIANNE KOENS

MATERIALS	Wood, metal, foam, fabric
LEGS	Powder coated steel
COLOR LEGS	RAL 9005, RAL 9001
FABRIC	Camira Era
	8 standard colors
DIMENSIONS	L 66 x W 77 x H 78 cm
	S-H 45 CM, A-H 62 CM
WEIGHT	14 KG
FIRE PROOF FOAM	Available upon request
SEE PAGE	10

DOST footstool

DESIGNED BY RIANNE KOENS

MATERIALS	Wood, metal, foam, fabric
LEGS	Powder coated steel
COLOR LEGS	RAL 9005, RAL 9001
FABRIC	Camira Era
	8 standard colors
DIMENSIONS	L 66 x W 41 x H 45 cm
	S-H 45 CM
WEIGHT	6 KG
FIRE PROOF FOAM	Available upon request
SEE PAGE	10

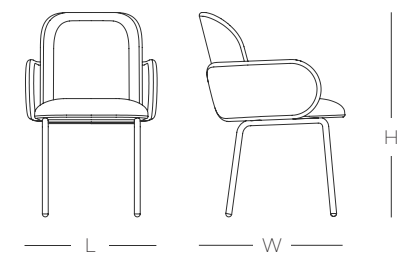
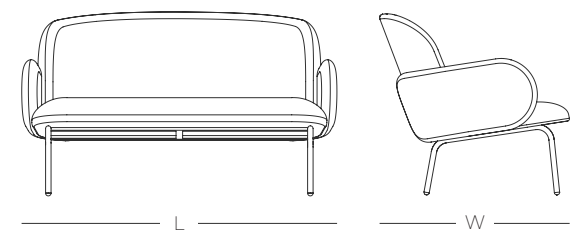
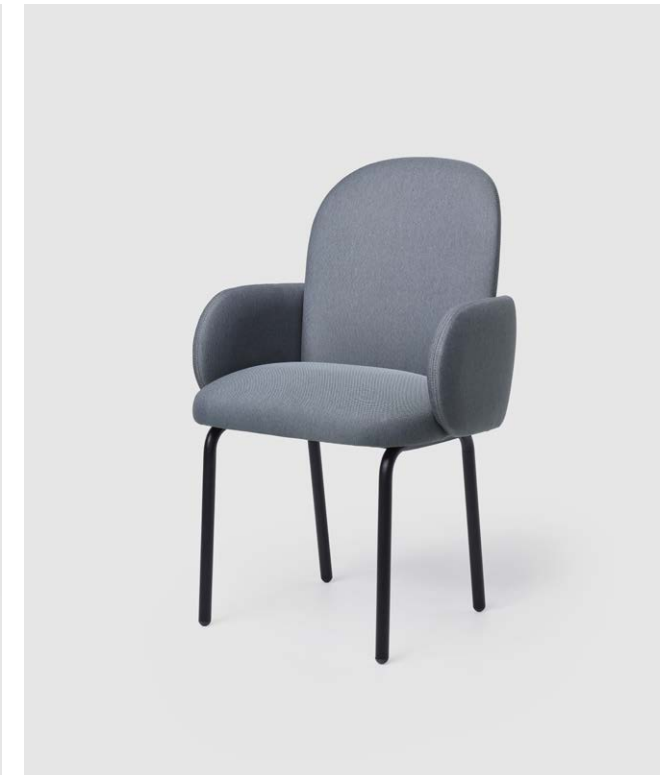

DOST sofa

DESIGNED BY RIANNE KOENS

MATERIALS	Wood, metal, foam, fabric
LEGS	Powder coated steel
COLOR LEGS	RAL 9005, RAL 9001
FABRIC	Camira Era
	8 standard colors
DIMENSIONS	L 148 x W 77 x H 78 cm
	S-H 45 CM, A-H 62 CM
WEIGHT	20 KG
FIRE PROOF FOAM	Available upon request
SEE PAGE	12

DOST diner chair

DESIGNED BY RIANNE KOENS

MATERIALS	Wood, metal, foam, fabric
LEGS	Powder coated steel
COLOR LEGS	RAL 9005, RAL 9001
FABRIC	Camira Era
	8 standard colors
DIMENSIONS	L 58 x W 60 x H 88 CM
	S-H 46,5 CM, A-H 65 CM
WEIGHT	10 KG
FIRE PROOF FOAM	Available upon request
SEE PAGE	14

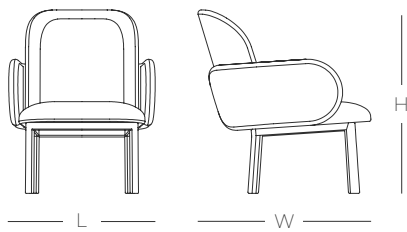

DOST lounge chair

DESIGNED BY RIANNE KOENS

MATERIALS	Wood, foam, fabric
LEGS	Wood
FABRIC	Camira Era
	8 standard colors
DIMENSIONS	L 66 x W 77 x H 78 cm S-H 45 CM, A-H 62 CM
WEIGHT	14 KG
FIRE PROOF FOAM	Available upon request
SEE PAGE	10

DOST footstool

DESIGNED BY RIANNE KOENS

MATERIALS	Wood, foam, fabric
LEGS	Wood
FABRIC	Camira Era
	8 standard colors
DIMENSIONS	L 66 x W 41 x H 45 cm S-H 45 cm
WEIGHT	6 KG
FIRE PROOF FOAM	Available upon request
SEE PAGE	10

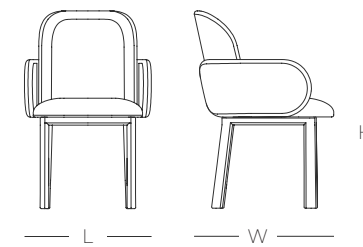
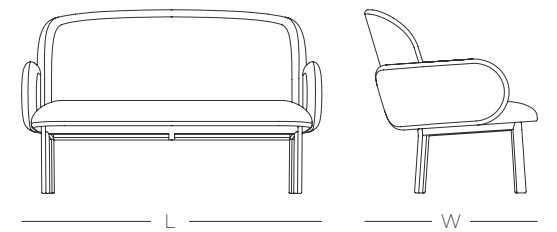

DOST sofa

DESIGNED BY RIANNE KOENS

MATERIALS	Wood, foam, fabric
LEGS	Wood
FABRIC	Camira Era
	8 standard colors
DIMENSIONS	L 148 x W 77 x H 78 cm S-H 45 CM, A-H 62 CM
WEIGHT	20 KG
FIRE PROOF FOAM	Available upon request
SEE PAGE	12

DOST diner chair

DESIGNED BY RIANNE KOENS

MATERIALS	Wood, foam, fabric
LEGS	Wood
FABRIC	Camira Era
	8 standard colors
DIMENSIONS	L 58 x W 60 x H 88 CM S-H 46,5 CM, A-H 65 CM
WEIGHT	10 KG
FIRE PROOF FOAM	Available upon request
SEE PAGE	14

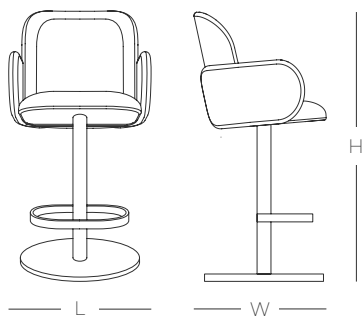
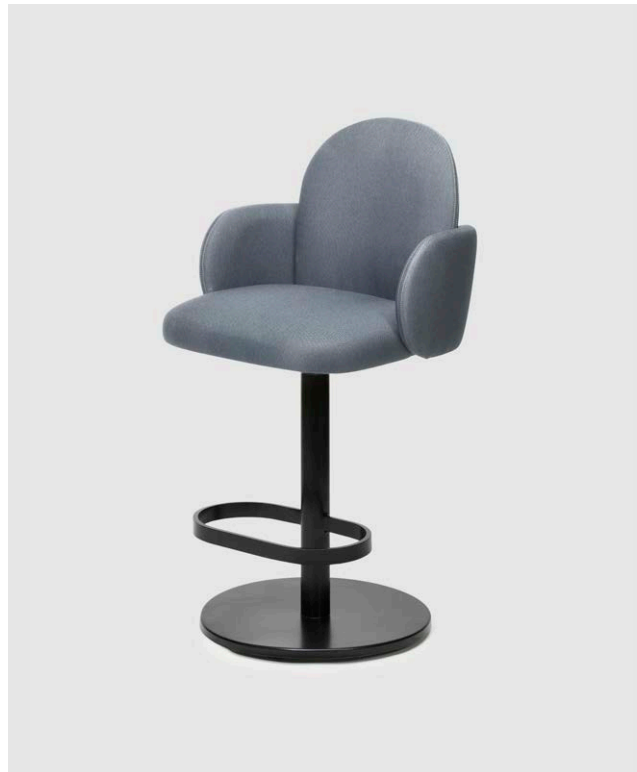

DOST bar chair

DESIGNED BY RIANNE KOENS

MATERIALS	Wood, metal, foam, fabric
LEGS	Powder coated steel
COLOR	RAL 9005, RAL 9001
FABRIC	Camira Era
	8 standard colors
DIMENSIONS	L 45 x W 45 x H 100
	S-H 60 cm, F-H 23cm
WEIGHT	17 KG
FIRE PROOF FOAM	Available upon request
SEE PAGE	16

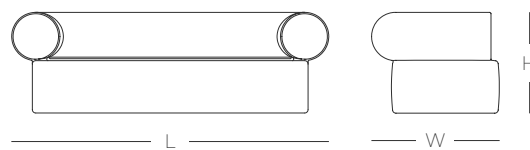

CHESTER couch

DESIGNED BY LEX POTT

MATERIALS	Wood, foam, fabric
FABRIC	Chop
	11 standard colors
DIMENSIONS	2P L 200 x W 94 x H 73 CM
	2,5P L 225 x W 94 x H 73 CM
	S-H 44 CM, A-H 73 CM
WEIGHT	2P 60 KG
	2,5P 65 KG
FIRE PROOF FOAM	Available upon request
SEE PAGE	18

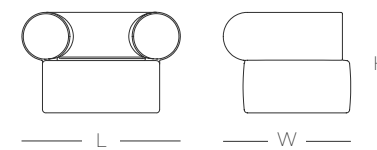

CHESTER lounge chair

DESIGNED BY LEX POTT

MATERIALS	Wood, foam, fabric
FABRIC	Chop
	11 standard colors
DIMENSIONS	L 114 x W 94 x H 73
	S-H 44 CM, A-H 73 CM
WEIGHT	32 KG
FIRE PROOF FOAM	Available upon request
SEE PAGE	18

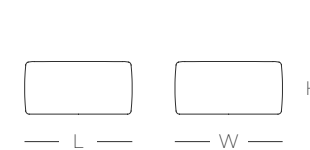

CHESTER footstool

DESIGNED BY LEX POTT

MATERIALS	Wood, foam, fabric
FABRIC	Chop
	11 standard colors
DIMENSIONS	L 87 x W 82 x H 44 CM
	S-H 44 CM
WEIGHT	24 KG
FIRE PROOF FOAM	Available upon request
SEE PAGE	18

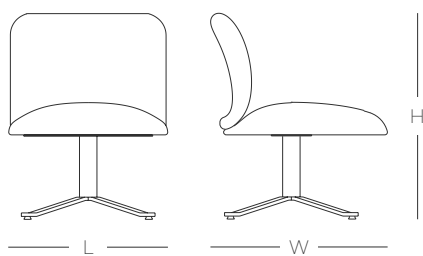
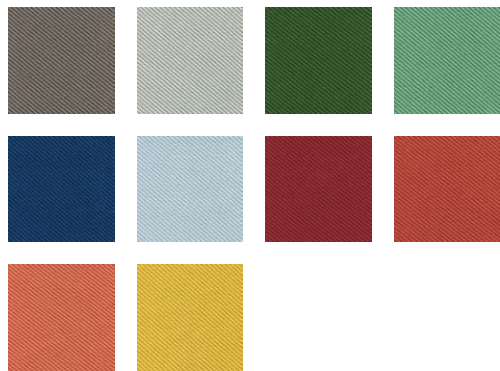

OPTUM lounge chair

DESIGNED BY RIANNE KOENS

MATERIALS	Wood, metal, foam, fabric
LEGS	Powder coated steel
COLOR	RAL 9005, RAL 9001
FABRIC	Camira Oceanic
	10 standard colors
DIMENSIONS	L 64 x W 74 x H 78 cm
	S-H 46 cm
WEIGHT	20 KG
FIRE PROOF FOAM	Available upon request
SEE PAGE	22

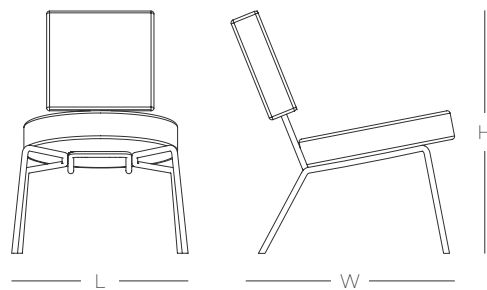

OPTION lounge chair

DESIGNED BY FREDERIK ROIJE

MATERIALS	Wood, metal, foam, fabric
LEGS	Powder coated steel
COLOR	RAL 9011, RAL 5011, RAL 9001
FABRIC	Taro
	8 standard colors
DIMENSIONS	L 61 x W 74 x H 77 cm
	S-H 46 cm
WEIGHT	12 KG
FIRE PROOF FOAM	Available upon request
SEE PAGE	26

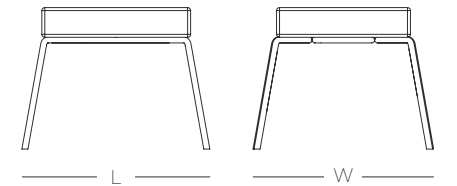
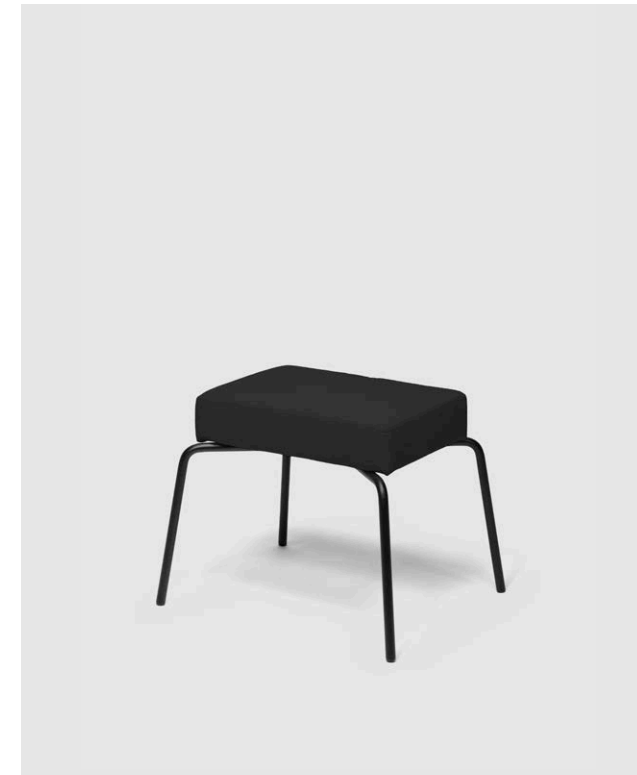

OPTION footstool

DESIGNED BY FREDERIK ROIJE

MATERIALS	Wood, metal, foam, fabric
LEGS	Powder coated steel
COLOR	RAL 9011, RAL 5011, RAL 9001
FABRIC	Taro
	8 standard colors
DIMENSIONS	L 61 x W 48 x H 46 cm
	S-H 46 cm
WEIGHT	5 KG
FIRE PROOF FOAM	Available upon request
SEE PAGE	26

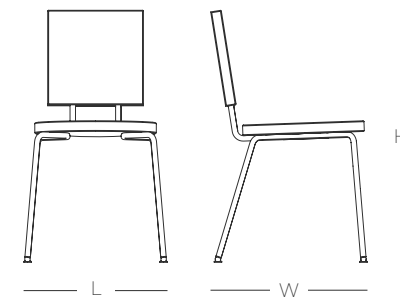
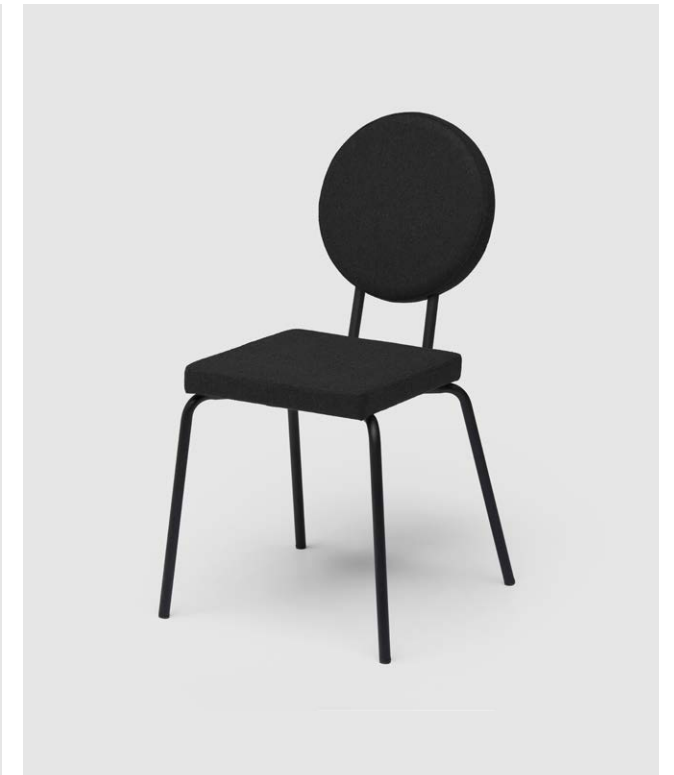

OPTION diner chair

DESIGNED BY FREDERIK ROIJE

MATERIALS	Wood, metal, foam, fabric
LEGS	Powder coated steel
COLOR	RAL 9011, RAL 5011, RAL 9001
FABRIC	Taro
	8 standard colors
DIMENSIONS	L 48 x W 51 x H 85 cm
	S-H 45 CM
WEIGHT	6 KG
FIRE PROOF FOAM	Available upon request
SEE PAGE	30

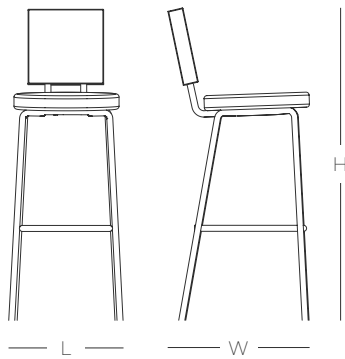

OPTION bar chair

DESIGNED BY FREDERIK ROIJE

MATERIALS	Wood, metal, foam, fabric
LEGS	Powder coated steel
COLOR	RAL 9011, RAL 5011, RAL 9001
FABRIC	Taro
	8 standard colors
DIMENSIONS	L 40 x W 43 x H 110 cm
	S-H 76 cm
WEIGHT	8 KG
FIRE PROOF FOAM	Available upon request
SEE PAGE	32

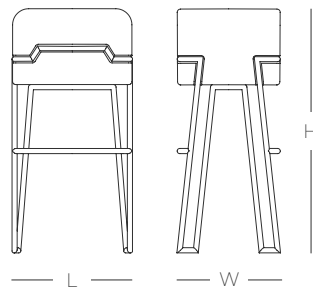

BOKK bar stool

DESIGNED BY KA-LAI CHAN

MATERIALS	Metal, foam, fabric, leather
LEGS	Powder coated steel
COLOR	RAL 9005
FABRIC	60% wool – 40% polyester
	Cow leather
	5 standard colors
DIMENSIONS	L 37 x W 28 x H 75 cm
	S-H 75 cm
WEIGHT	7 KG
SEE PAGE	36

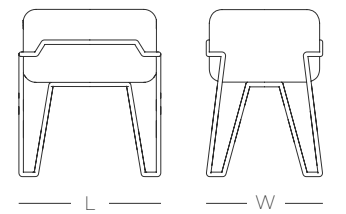

BOKK stool

DESIGNED BY KA-LAI CHAN

MATERIALS	Metal, foam, fabric, leather
LEGS	Powder coated steel
COLOR	RAL 9005
FABRIC	60% wool – 40% polyester
	Cow leather
	5 standard colors
DIMENSIONS	L 37 x W 28 x H 46 cm
	S-H 46 cm
WEIGHT	6 KG
SEE PAGE	36

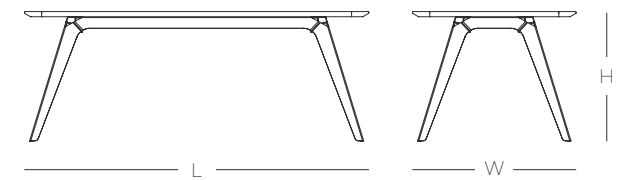
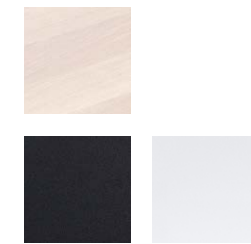
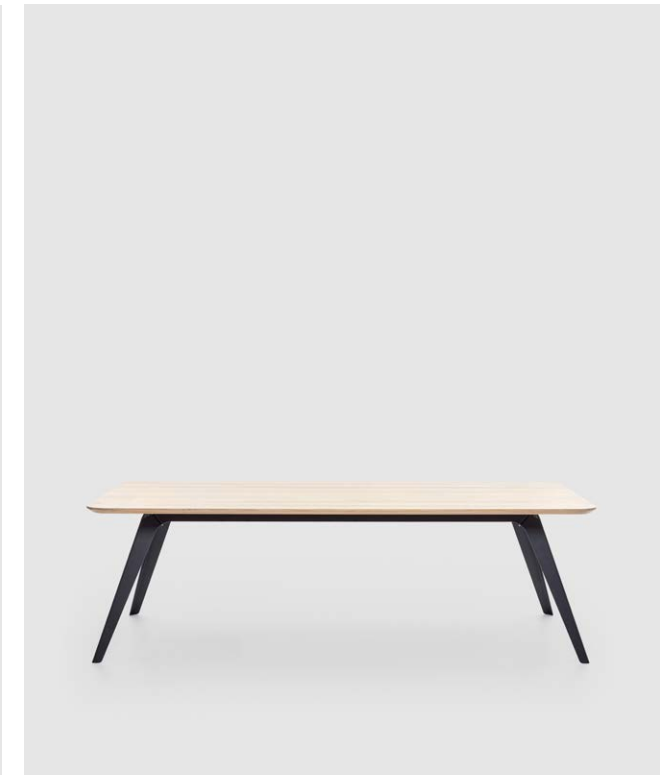

FOLD dining table

DESIGNED BY BAS VELLEKOOP

MATERIALS	Wood, metal
LEGS	Powder coated steel
COLOR	RAL 9005, RAL 9010
DIMENSIONS	L 200/240 x W 100 x H 75 cm
WEIGHT	70 KG
CARE	Our Fold table top is made with a solid wooden oak, a product of nature. Every table top is unique, little imperfections are unavoidable.
SEE PAGE	38

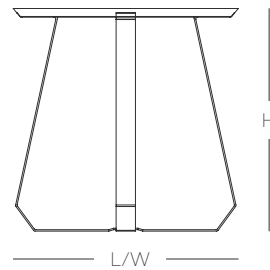
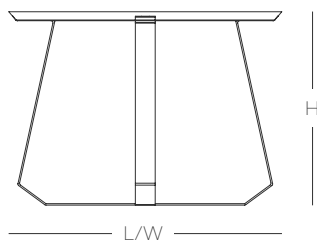
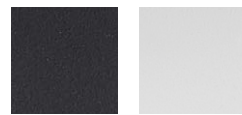

SHUNAN LOW side table

DESIGNED BY NIEUWE HEREN

MATERIALS Ashwood veneer, steel
 LEGS Powder coated steel
 COLOR RAL 9005, RAL 9010
 DIMENSIONS L 55 x W 55 x H 40 cm
 WEIGHT 2 KG
 SEE PAGE 40

SHUNAN NORMAL side table

DESIGNED BY NIEUWE HEREN

MATERIALS Ashwood veneer, steel
 LEGS Powder coated steel
 COLOR RAL 9005, RAL 9010
 DIMENSIONS L 46 x W 46 x H 46 cm
 WEIGHT 1,5 KG
 SEE PAGE 40

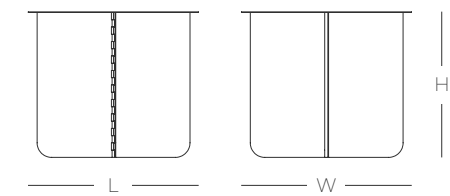
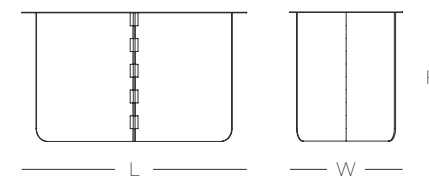
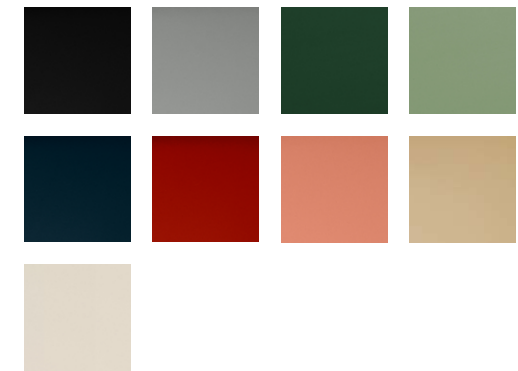
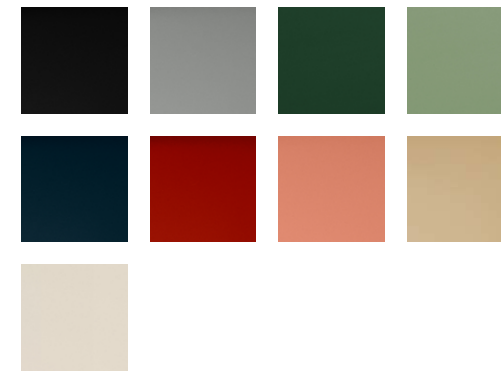

HINGE LARGE side table

DESIGNED BY LEX POTT

MATERIALS Powder coated steel
 LEGS Powder coated steel
 COLOR 9 standard colors
 DIMENSIONS L 70 x W 35 x H 30 cm
 WEIGHT 13,5 KG
 SEE PAGE 42

HINGE MEDIUM side table

DESIGNED BY LEX POTT

MATERIALS Powder coated steel
 LEGS Powder coated steel
 COLOR 9 standard colors
 DIMENSIONS L 40 x W 40 x H 45 cm
 WEIGHT 11 KG
 SEE PAGE 42

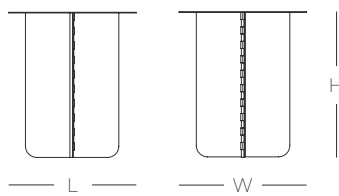
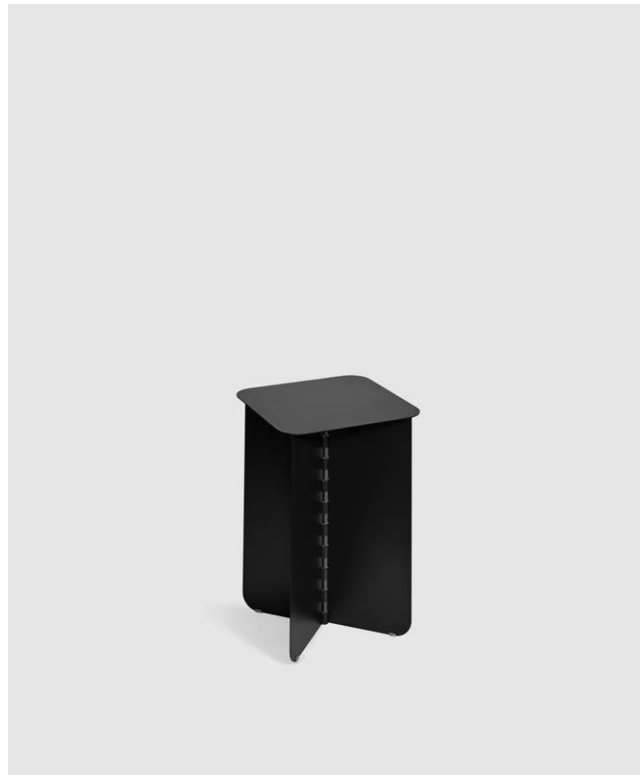

HINGE SMALL side table

DESIGNED BY LEX POTT

MATERIALS	Powder coated steel
LEGS	Powder coated steel
COLOR	9 standard colors
DIMENSIONS	L 30 x W 30 x H 45 cm
WEIGHT	8 KG
SEE PAGE	42

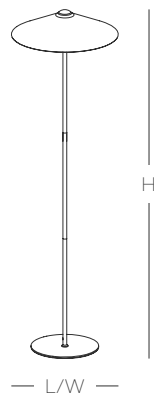

BONNETT TALL floor lamp

DESIGNED BY LEX POTT

MATERIALS	Powder coated steel, glass
COLOR	1 standard color
DIMENSIONS	L 44 x W 44 x H 152 cm
WEIGHT	4,6 KG
SEE PAGE	44

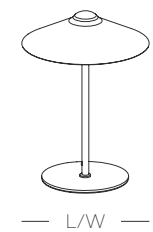

BONNETT SMALL table lamp

DESIGNED BY LEX POTT

MATERIALS	Powder coated steel, glass
COLOR	1 standard color
DIMENSIONS	L 29 x W 29 x H 41 cm
WEIGHT	2,4 KG
SEE PAGE	44

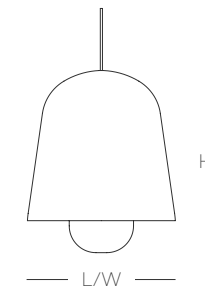

CONE ceiling light

DESIGNED BY KRANEN/GILLE

MATERIALS	Powder coated steel, glass
COLOR	4 standard colors
DIMENSIONS	L 27,5 x W 27,5 x H 34 cm
CORD LENGTH	4m
WEIGHT	4,5 KG
SEE PAGE	46

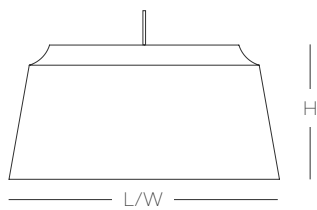

GROOVE LARGE ceiling light

DESIGNED BY ILIAS ERNST

MATERIALS	Powder coated steel
COLOR	4 standard colors
DIMENSIONS	L 41 x W 41 x H 22 cm
CORD LENGTH	4m
WEIGHT	2 KG
SEE PAGE	48

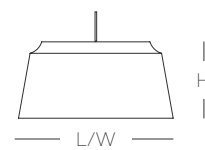

GROOVE SMALL ceiling light

DESIGNED BY ILIAS ERNST

MATERIALS	Powder coated steel
COLOR	4 standard colors
DIMENSIONS	L 27 x W 27 x H 15 cm
CORD LENGTH	4m
WEIGHT	1,5 KG
SEE PAGE	48

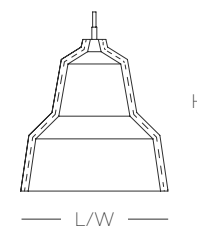
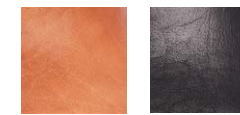

LLOYD ceiling light

DESIGNED BY NIEUWE HEREN

MATERIALS	Leather, wood
COLOR	2 standard colors
DIMENSIONS	L 24 x W 24 x H 25 cm
CORD LENGTH	4m
WEIGHT	1,5 KG
SEE PAGE	50

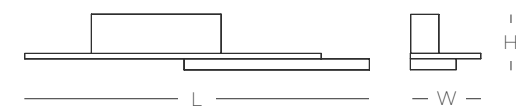
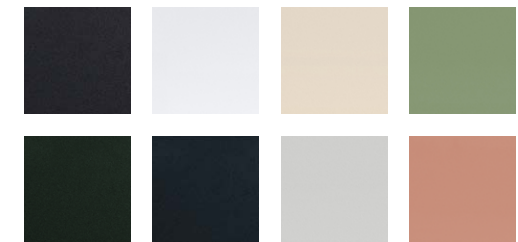
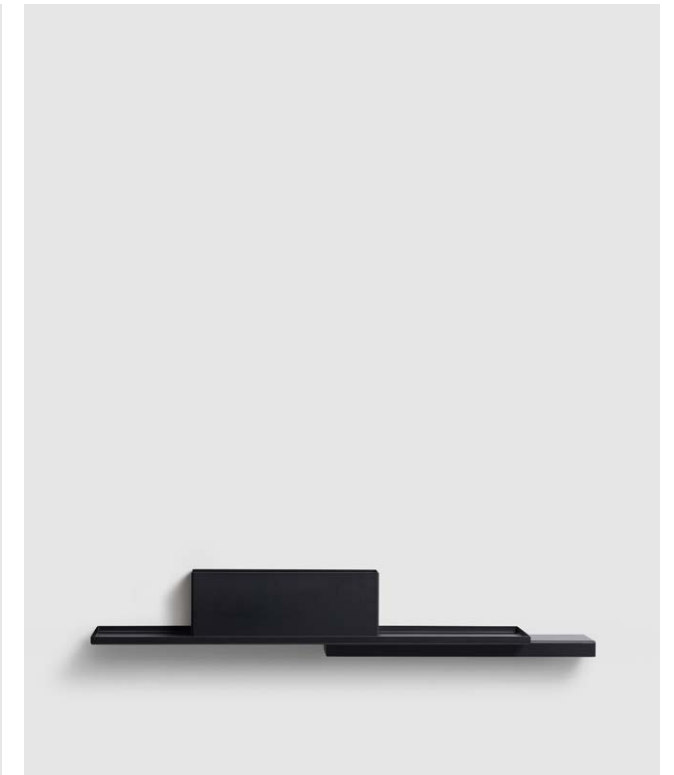

DUPLEX wallshelf

DESIGNED BY FREDERIK ROIJE

MATERIALS	Powder coated steel
COLOR	8 standard colors
DIMENSIONS	L 93 x W 20 x H 15 cm
WEIGHT	6 KG
SEE PAGE	52

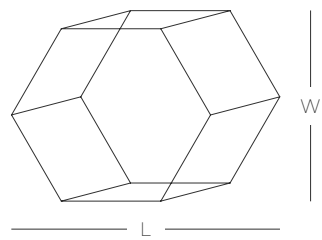
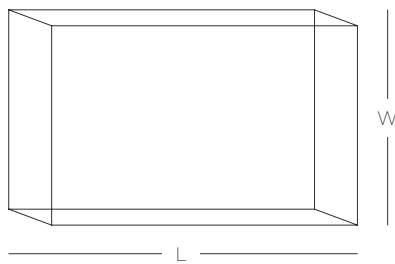
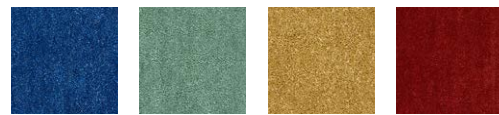
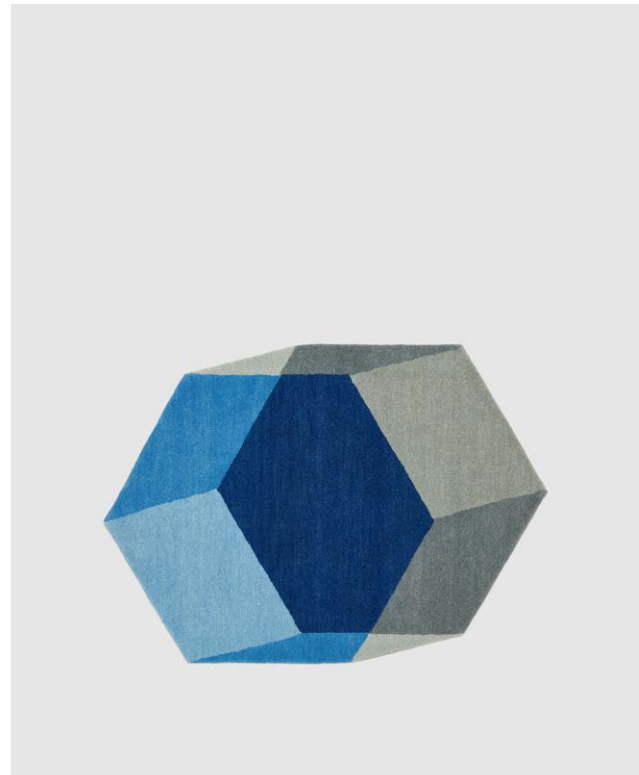

ISO RECTANGLE carpet

DESIGNED BY ONTWERPDUO

MATERIALS	100% wool
COLOR	3 standard colors
DIMENSIONS	L 260 x W 162
WEIGHT	17 KG
SEE PAGE	54

ISO HEXAGON carpet

DESIGNED BY ONTWERPDUO

MATERIALS	100% wool
COLOR	3 standard colors
DIMENSIONS	L 200 x W 142
WEIGHT	13 KG
SEE PAGE	54

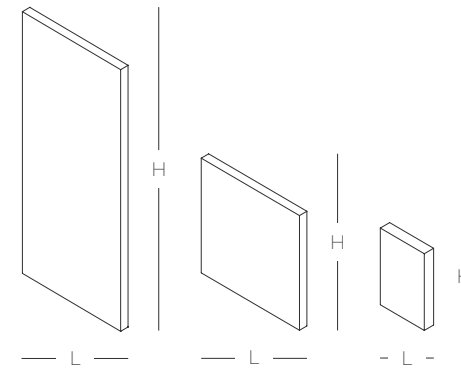

FACETT mirror

DESIGNED BY LEX POTT

MATERIALS	Glass
COLOR	1 standard color
DIMENSIONS	Large L 50 x H 150 cm Medium L 50 x H 82,5 cm Small L 20 x H 40 cm
WEIGHT	Large 11,5 KG Medium 7,5 KG Small 2 KG
SEE PAGE	56

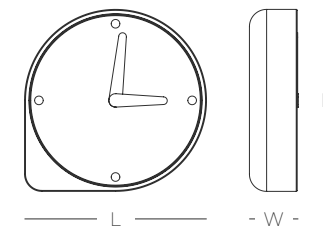
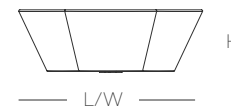
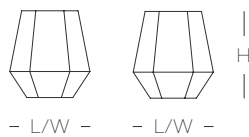
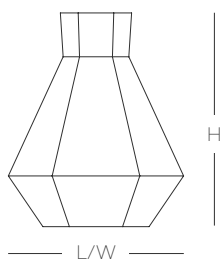
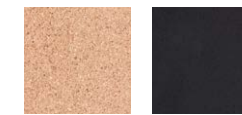

RARE carafe

DESIGNED BY LARA VAN DER LUGT

MATERIALS	Glass
COLOR	1 standard color
DIMENSIONS	L 16,5 x W 16,5 x H 20,5 cm
CAPACITY	1,2l
WEIGHT	0,65 KG
SEE PAGE	60

RADIANT glasses set

DESIGNED BY LARA VAN DER LUGT

MATERIALS	Glass
COLOR	1 standard color
DIMENSIONS	L 9 x W 9 x H 9 cm
SET	2 pcs
WEIGHT	0,6 KG
SEE PAGE	60

LUCENT serving bowl

DESIGNED BY LARA VAN DER LUGT

MATERIALS	Glass
COLOR	1 standard color
DIMENSIONS	L 16 x W 16 x H 5,5 cm
SET	2 pcs
WEIGHT	0,95 KG
SEE PAGE	60

CLOK table clock

DESIGNED BY ILIAS ERNST

MATERIALS	Cork, powder coated steel
COLOR	2 standard colors
DIMENSIONS	L 19 x W 5 x H 19 cm
WEIGHT	0,75 KG
SEE PAGE	64

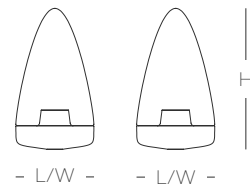
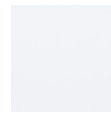

BOEIEN salt and pepper set

DESIGNED BY KA-LAI CHAN

MATERIALS	Glass, cork
COLOR	1 standard color
DIMENSIONS	L 5 x W 5 x H 10 cm
SET	2 pcs
WEIGHT	0,135 KG
SEE PAGE	66

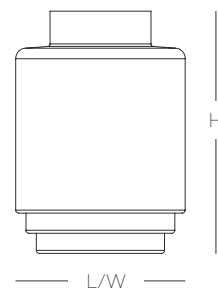

MONDAY VASE flower vase

DESIGNED BY SIEBRING/ZOETMULDER

MATERIALS	Glass
COLOR	1 standard color
DIMENSIONS	L 21 x W 21 x H 27 cm
WEIGHT	1,5 KG
SEE PAGE	68

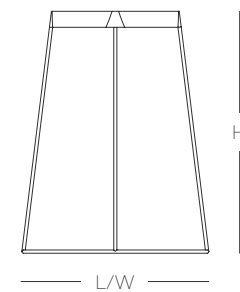

MONDAY STANDARD vase standard

DESIGNED BY SIEBRING/ZOETMULDER

MATERIALS	Steel
COLOR	2 standard colors
DIMENSIONS	L 24 x W 24 x H 30 cm
CAPACITY	0,4 KG
WEIGHT	0,65 kg
SEE PAGE	68

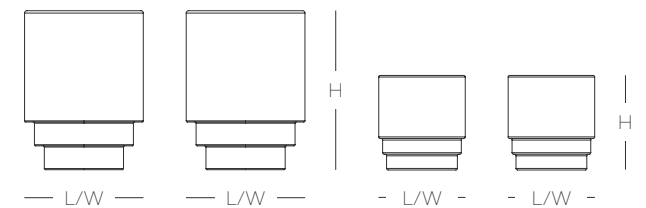

MONDAY MUG ceramic mug

DESIGNED BY SIEBRING/ZOETMULDER

MATERIALS	Ceramic
COLOR	3 standard colors
DIMENSIONS	L 7,5 x W 7,5 x H 10,5 cm L 5,5 x W 5,5 x H 6 cm
SET	2 pcs
CAPACITY	Mug 0,25 l Espresso 0,075 l
WEIGHT	Mug 0,5 KG Espresso 0,3 KG
SEE PAGE	70

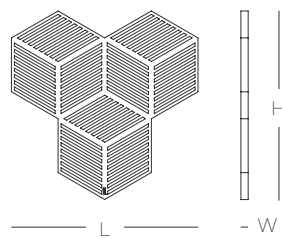
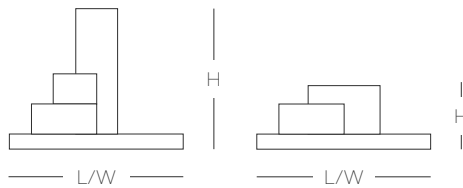
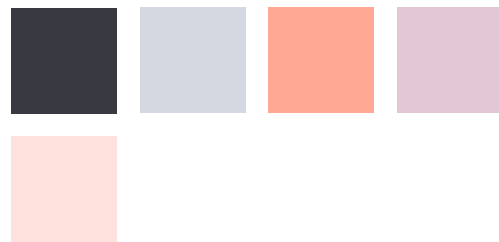
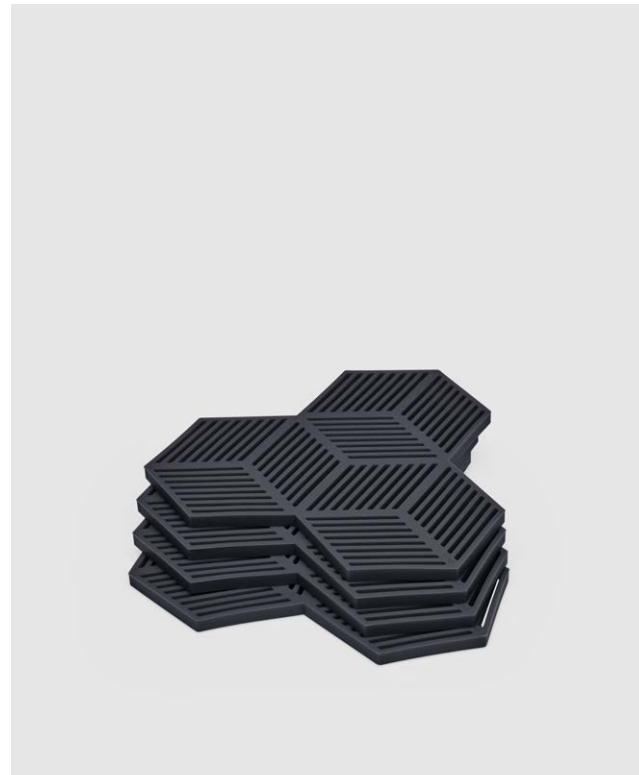
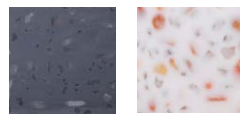

PLY candle holder & tealight

DESIGNED BY ISABEL QUIROGA

MATERIALS	Terrazzo, steel
COLOR	2 standard colors
DIMENSIONS	Candle L 10 x W 10 x H 10 cm Tea L 10 x W 10 x H 5,5 cm
WEIGHT	Candle 0,4 kg Tea 0,35 KG
SEE PAGE	72

SICO coaster

DESIGNED BY CECILIA VALENTINE

MATERIALS	Silicone
COLOR	5 standard colors
DIMENSIONS	L 15 x W 0,5 x H 16 cm
SET	4 pcs
WEIGHT	0,28 kg
SEE PAGE	74

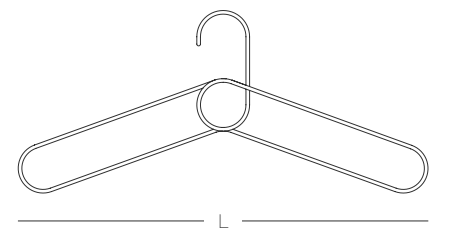
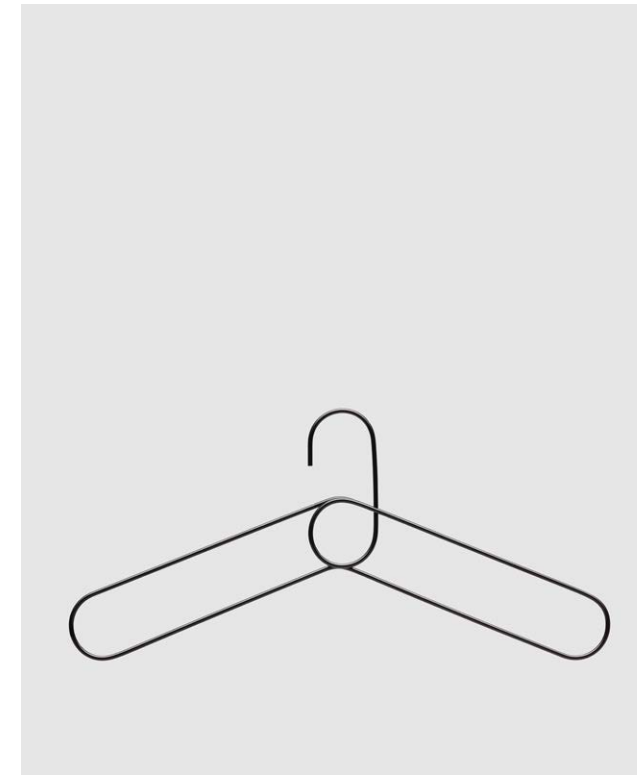

LOOP clothing hanger

DESIGNED BY LEX POTT

MATERIALS	Steel
COLOR	2 standard colors
DIMENSIONS	L 45 x W 0,5 x H 12 cm
SET	3 pcs
WEIGHT	0,9 KG
SEE PAGE	76

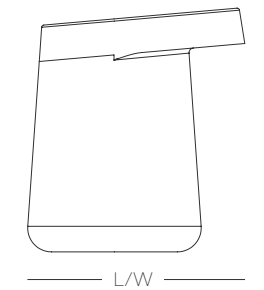
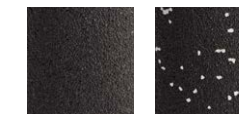

HAT wine cooler

DESIGNED BY ILIAS ERNST

MATERIALS	EPP
COLOR	2 standard colors
DIMENSIONS	L 17 x W 17 x H 21 cm
WEIGHT	0,37 KG
SEE PAGE	78

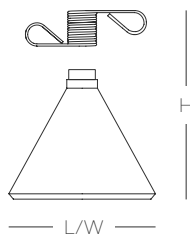

CONIC candle holder

DESIGNED BY ISABEL QUIROGA

MATERIALS Concrete, steel
 COLOR 2 standard colors
 DIMENSIONS L 13 x W 13 x H 14 cm
 WEIGHT 1,45 KG
 SEE PAGE 80

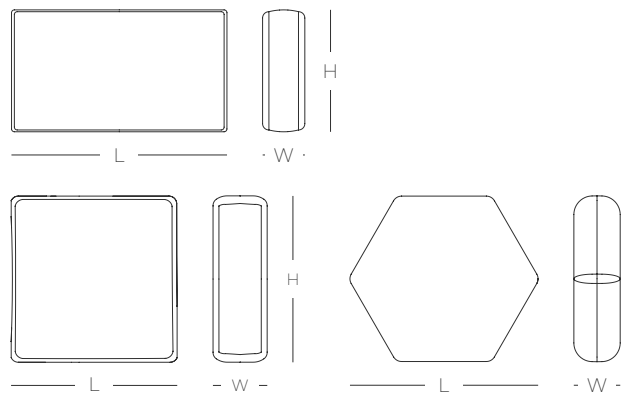

PLUS RECTANGLE pillow

DESIGNED BY ONTWERPDUO

MATERIALS Velvet fabric, duck feathers
 COLOR 5 standard colors
 DIMENSIONS
 Rectangle L 45 x W 10 x H 19 cm
 Square L 40 x W 13 x H 40 cm
 Hexagon L 36 x W 10 x H 41 cm
 WEIGHT 1 kg
 SEE PAGE 82

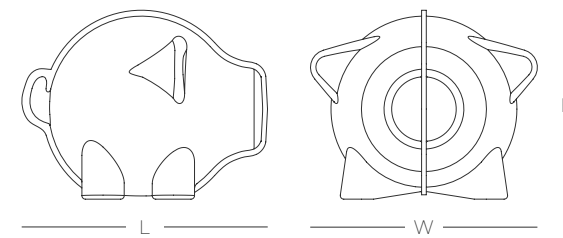

TAMMY piggy bank

DESIGNED BY PUIK

MATERIALS Paperpulp
 COLOR 1 standard color
 DIMENSIONS L 21 x W 19 x H 16 cm
 WEIGHT 0,23 KG
 SEE PAGE 84

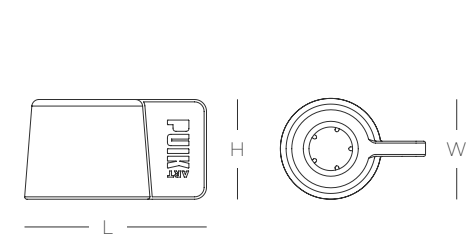

SILLY candle holder

DESIGNED BY BASTIAAN HEMMES

MATERIALS Silicone
 COLOR 3 standard colors
 DIMENSIONS L 10,5 x W 8 x H 6,5 cm
 SET 2 pcs
 WEIGHT 0,2 KG
 SEE PAGE 86

PHOTOGRAPHY
GRAPHIC DESIGN
COPYWRITERS

Studio Zelden, Jeroen van der Wielen, Maarten Willemstein
Lara van der Lugt
Marit Bohnenn, Alexandra Finlay, Victoria Smith

