

uHave Control



uSwitch™ Product Family Installation and Operating Manual



Table of Contents

Introduction..... 3

uSwitch and uSwitchPro Features 4

uSwitch PoE Features..... 5

Installation Guidelines (Read before Installing) 6

uSwitch and uSwitchPro Quick Start Guide..... 6

uSwitch PoE Quick Start Guide 7

About uSwitch 9

Power Supply Connection..... 10

Relay Connection 10

Network Connection..... 10

Control Center – Home Page..... 12

uSwitch and uSwitchPro 12

Menu Navigation 14

Control Center (Relay 1- Resetable-Momentary Mode)..... 15

Control Center (Relay1 Watchdog Mode, Startup Delay phase)..... 15

Control Center (Relay1 Watchdog Mode, Ping Delay phase) 17

Control Center (Relay1 Watchdog Mode, pinging phase) 17

Control Center (Relay1 Watchdog Mode, auto reboot countdown phase)..... 19

Control Center (Relay1 Watchdog Mode, Fault Mode)..... 20

..... 20

..... 20

Control Center (GPIO1 with counter enabled)..... 20

Network Configuration Page 22

Relay Configuration Page 26

Force Watchdog Reboot 29

GPIO Configuration Page (uSwitchPro only)..... 30

..... 30

Watchdog Configuration Page..... 31

Virtual Relay Configuration Page 33

Scheduled Event Page..... 35

..... 35

Scheduled Event Page..... 35

Authorization Configuration Page 36

Security Notes 36

uSwitch/uSwitchPro Board Schematic..... 37

Access Control to Electronic Door Strike	38
Driving multiple uSwitch Relays from a single uSwitch GPIO or Virtual Button	38
Connecting to High Power devices (such as Motors, etc)	39
Hard Wired Network Connection.....	40
Troubleshooting:	42
Appendix A: Factory Default Settings	43
Appendix B: Specifications.....	44
Appendix C: Updating Firmware	46
Product Safety: FCC Statement.....	51
Warranty.....	52
Trademark and Copyright Information	53

Introduction



uHave Control specializes in practical solutions for your network allowing you to *Stay Connected and Take Control*. All our industrial rated solutions keep you connected to the internet of things (IOT).

The uSwitch™ allows you to control any device over the web including gates, doors, lights, sirens, doors, modems and cameras whether you are next door or halfway across the world. uSwitch can also restart any network device automatically when it locks up or stops communicating, saving you costly site visits, dissatisfied customers and time consuming manual reboots. uSwitch is the perfect solution for industrial, security and machine to machine applications.

Simple to use and with no programming required, uSwitch automatically builds a control web page, provides multiple levels of password protected and can operate stand alone or user directed via the Internet or a local intranet.

uSwitch comes with removable terminal connectors for the simplest wiring to two electromechanical relays that can be used as a dry contacts or power switches for remote control via the built-in web server. **Uswitch PoE has a single external Relay, an auto rebootable auto-voltage sensing PoE switch and an external 12Vdc power connection terminal.**

Once connected anywhere, users can monitor, control and reboot any device over the web or over a network whether under a desk on top of a pole, at a remote construction site, summer homes or business. In addition to computers and

iPads, uSwitch is compatible with Android, iPhone, Blackberry and many other smart devices providing true remote control anywhere and anytime.

uSwitchPro™ adds several highend features to the standard uSwitch™ including General Purpose Inputs (GPIOs), and Virtual Relays and Master Slave pier-to-pier control..

This manual covers uSwitch™, uSwitchPro™, and uSwitchPoE™. All exclusive features to the uSwitchPro will be, as this text is, on a light blue background, differentiating its advanced features, and features exclusive to uSwitchPoE will be highlighted in gray.

This manual also covers the uSwitchPoE™ a specialized version of the uSwitch which includes a watchdog, protecting an auto voltage ranging 4-port 802.11af PoE switch, a 2nd dry contact relay and a 12VDC power output port.A

Additionally, this manual covers the most popular adapters to the uSwitch including the A-plug™ a universal remotely controlled 110Vac power adapter.

uSwitch and uSwitchPro Features

- Plug-and-Play
- Two dry contact relays (5A@120Vac, 3A@250VAC), (5A@120VDC, 3A@ 250VDC) for direct connection to load. (Not designed for devices with large inrush current)
- No programming requiredAuto Discovery mode user configurable
- Connect from computers, smart phones, iPads and other web and network devices
- May be used as a standalone device
- Built-in web pages provide simple user interface for configuration and control.
- Customizable user interface (customize controls, colors, text and buttons).
- Removable terminal connectors (included) simplify wiring and service
- Custom applications can control uSwitch with standard CGI interface.
- Multiple levels of password protection
- Supports fixed IP, DHCP with Dynamic IP with port forwarding and virtual port addressing.
- Selectable TCP & HTTP ports for proxy server and NAT applications
- 10/100 Ethernet connectivity.
- Built-in automatic watchdog mode on each relay; with three independent user assignable ping-able URL options
- Watchdog Cloak™ mode for ultra-secure applications
- Watchdog fully user configurable
- Latched, Scheduled, Momentary, Timed modes for relays
- Relay power up state user configurable (Off, On, Last)
- Minimal footprint
- End flanges with through holes for easy mounting

Low power consumption

- On board relays can be linked directly to onboard GPIOs
- GPIO(s) and virtual buttons can drive relays on other uSwitch devices (Each Pro can drive up to 8 uSwitches and 16 relays which can be daisy chained to unlimited number of relays)

- Input Counters for tracking events
- Bootloader for in field upgrades
- Peer to Peer Communication
- Great documentation, Great support
- Manufactured and all Software from USA
- Single Source Documentation available upon request

uSwitch PoE Features

- All features of uSwitch standard (with exception of 2nd external relay)
- Side flanges with through holes for easy mounting
- 4-Port auto voltage sensing 802.13af Compliant PoE Switch
- 15.4 Watts per Channel
- Up to 48VDC per port
- 12VDC output
- One dry contact relay (5A@120Vac, 3A@250VAC), (5A@120VDC, 3A@ 250VDC) for direct connection to load.
(Not designed for devices with large inrush current)

Installation Guidelines (Read before Installing)

Opening the uSwitch enclosure or tampering voids the warranty.

1. Not weatherproof (do not install outdoors without proper environmental enclosure).
2. Disconnect removable terminal connectors from the uSwitch when wiring.
3. If connecting a relay output to a power source, disconnect the source prior to wiring to terminal connector.
4. We recommend installation by qualified personnel
5. Not designed to run in a radioactive environment
6. Must not be used for medical, lifesaving purposes, or for any purpose where its failure could cause serious injury, loss of life, or create significant financial losses.
7. Must be correctly wired. Incorrect wiring could result in damage to uSwitch or the device to which it is partnered.

uSwitch and uSwitchPro Quick Start Guide

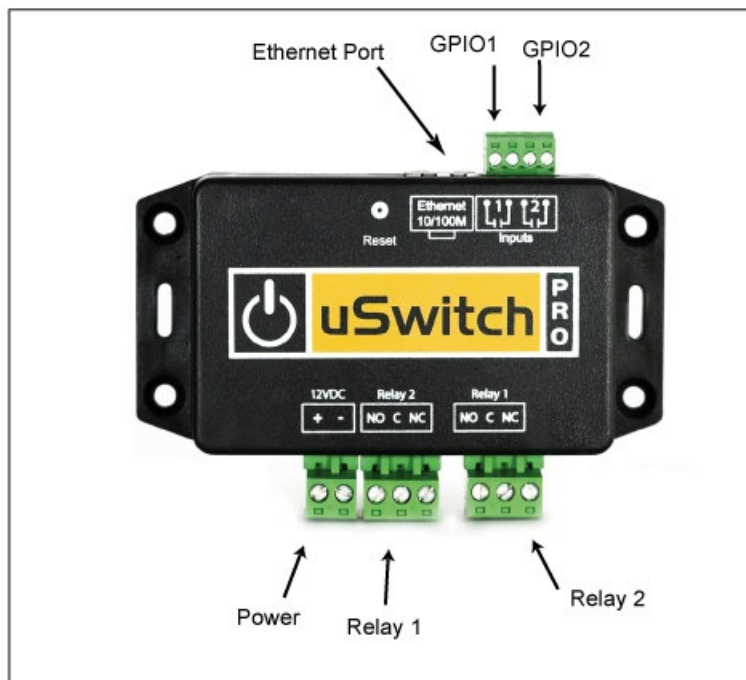

1. uSwitch and uSwitchPro can be connected to a DC power source in the range of 12-16Vdc. Connect an appropriate DC power supply to the **+** and **-** Terminals in Figure 1 (a regulated power supply is recommended). The power supply should be rated to meet the operating current of the uSwitch™ (see specifications for power requirements in appendix C). As shown in the photo, the positive terminal is the terminal closest to the outside edge; the negative terminal is the terminal closest to the relay 2 connector. For uSwitch PoE (shown below) the input voltage can be any voltage from 12-48VDC. The supplied voltage should be the greatest voltage (max 48VDC) required by any of the devices connected to a PoE port. The total rating of the supply should exceed the maximum power requirement of all connected PoE powered devices by 30%.

uSwitch PoE Quick Start Guide

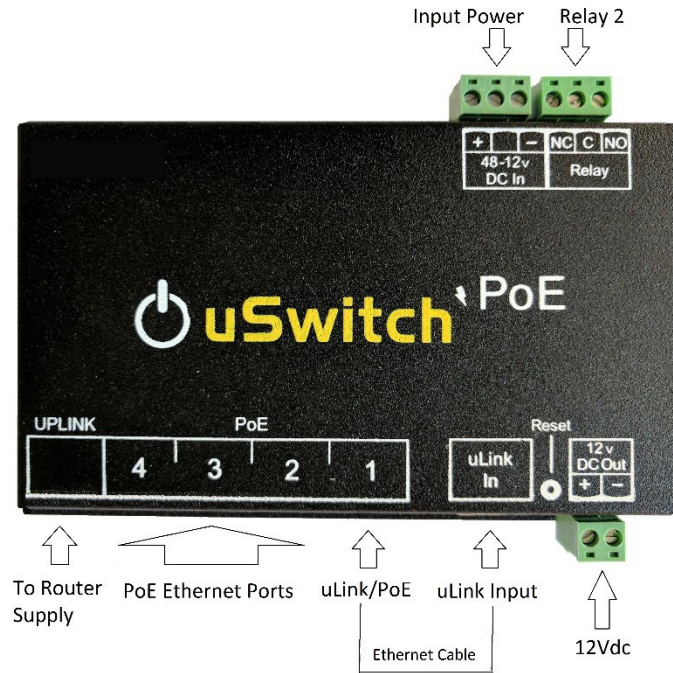

2. Connect an Ethernet cable between the uSwitch Ethernet port and an Ethernet port on the network switch/router (or directly to your computer's ethernet port). Connect a computer to the network switch/router. (See diagram below). Alternatively, you can connect the uSwitch directly to the Ethernet port of your computer (computer must be on a 192.168.1.xxx subnet and both should share the same gateway address and subnet mask to connect first time). For uSwitchPoE the Ethernet cable from the network should be connected to the port labeled UPLINK and the supplied short Ethernet cable should be connected between PoE port 1(uLink/PoE) and the port labeled "uLink In".

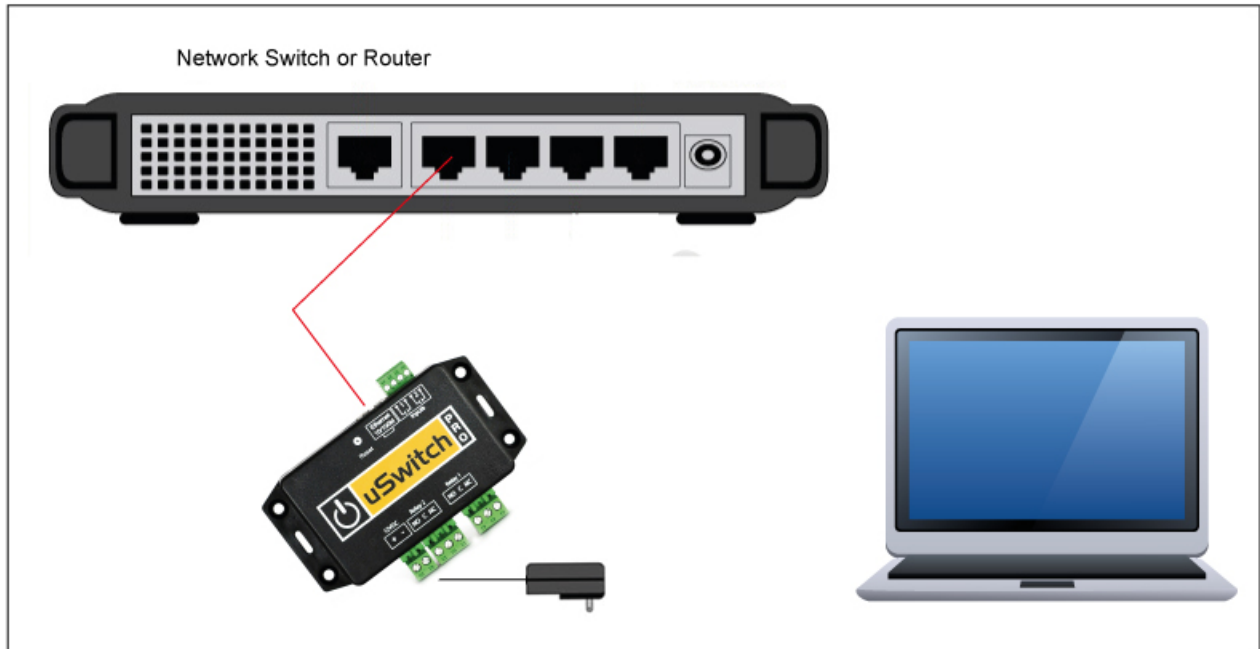

3. Set up a computer on the same network/subnet as the uSwitch. To do this, set the IP address of the computer to 192.168.1.x with subnet mask of 255.255.255.0 (x can be any unused address on that network 2-254) and should not be in a range reserved for DHCP by the router.

- Connect to all model uSwitches by entering the factory default IP address (<http://192.168.1.199>) into the address bar on your computer's browser. If the uSwitch is on a LAN with a router that has reserved the DHCP address of '192.168.1.199' a conflict can occur. In this case either change the default address of the uSwitch upon connection or remove '199' from the DHCP reserved address space of the router. (Make sure the uSwitch's address is not blocked by any firewall, gateway, or virus protection software you may have).
- If this is the first time you are logging on to the uSwitch from your computer, a password dialog box will appear (see examples below). Enter "admin", for both the User name and Password fields (all lower case). Once logged on passwords and user names can be changed from the Authorization Configuration Menu. For configuration level menus 'admin' is also the default password.

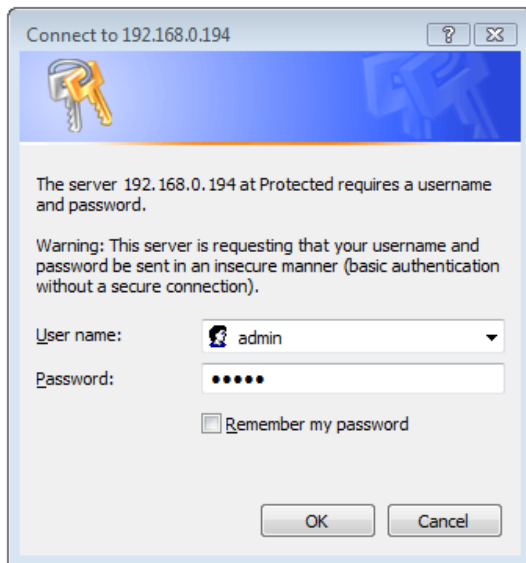

Windows Vista

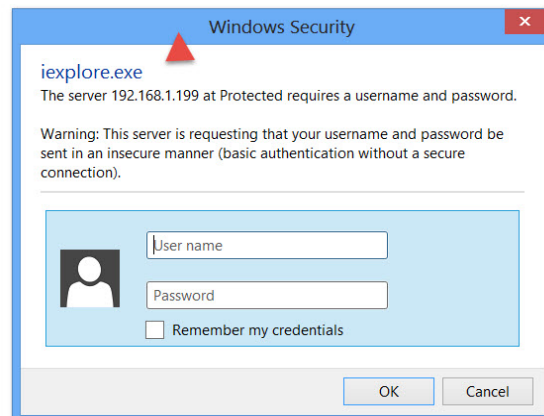

Windows 8

- Press "OK" to accept the username and password.
- Connect the relay contacts **and or GPIOs** as desired (refer to the diagram below for relay connections).

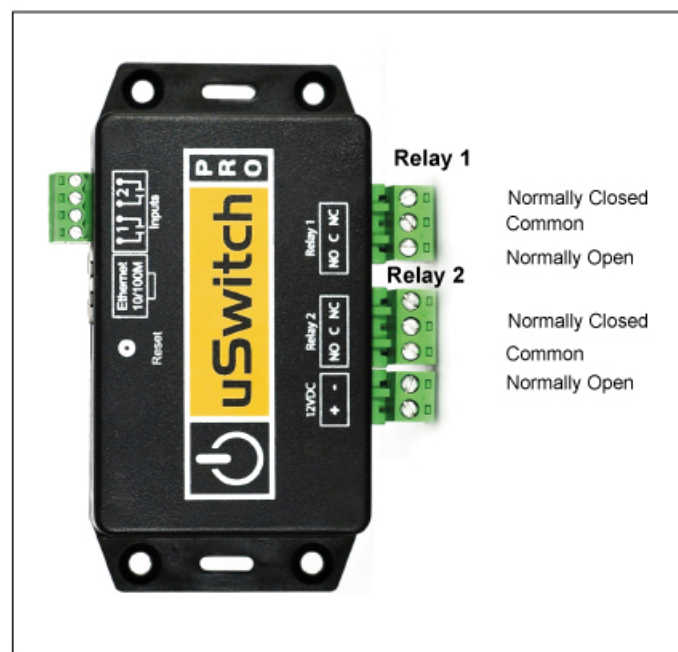

8. For uSwitchPoE you may connect all the three remaining PoE ports to PoE devices or non-PoE network devices (non-PoE devices will not auto-reboot when the PoE switch is rebooted so in this instance the PoE switch still provides network switching without auto-reboot capability). If a fourth PoE Port is required, then the uLink In and PoE Port 1 should not be connected (PoE port one can be a fourth PoE port). A second Ethernet cable must be connected to the modem or router on the network to the uSwitchPoE “uLink In” port. Providing two home run cables enables uSwitchPoE will have four fully functional PoE ports.

9.

About uSwitch

uSwitch contains two dry-contact electro-mechanical relays an RJ45 network connection port a built-in web-server and boot loader. The uSwitch’s web interface can be controlled and/or monitored over any IP network including private networks, VPNs, IP-based industrial control networks, and the Internet. uSwitch can be controlled from a web browser or via custom third party applications. Using standard CGI commands uSwitch can operate stand-alone or can be controlled from a remote or local web browser or custom application. It can be used to operate access control devices, lights, pumps, alarms, valves, gates locks, motors, etc.

Another feature of all uSwitch models is they can be programmed to automatically detect device and or network failures and restart electronic devices that have frozen, or stopped functioning properly (even when communication to uSwitch or device is completely lost). This mechanism is available to remotely reboot servers, computers, cell and satellite modems, IP cameras, and any other device one can imagine. uSwitch relays can be wired in series with the power source of the device and switch the power on and off manually. uSwitch relay can also be connected directly into a device’s reset circuit. In this configuration, uSwitch does not power down the device and initiate a cold reboot, it simply forces a warm restart by triggering a reset input. All reboot methods have different requirements in physical connection and setup. Additionally, a uSwitch can be wired directly to an external relay to control a physically isolated circuit or one with a power load that exceeds the max specifications of the internal relays within the uSwitch. For uSwitchPoE, the factory setting for the PoE dedicated relay is a manual momentary switch. In this mode the auto-reboot watchdog is off and the PoE portion of the uSwitch will operate as a fully functional, manually rebootable, PoE switch (it will not auto-reboot until it is configured to do so from the relay configuration screen. If Watchdog mode is configured the uSwitchPoE will automatically stop and re-apply power to connected PoE devices based on the user’s configuration parameters.

uSwitch has a built-in Web Interface. You can access uSwitch by its IP address if you are connecting to it from the same network or if you are on a remote WAN by the URL of the LAN and or the uSwitch’s assigned port (via port-forwarding/NAT). It can be accessed on networks with both static and dynamic IP addresses (in the case of a dynamic IP address, a dynamic IP client is required or a router supporting DDNS). The factory default IP address for uSwitch is: 192.168.1.199, its default network port is 80, the default gateway is 192.168.1.1.

uSwitchPro provides two General Purpose inputs (GPIOs). These GPIOs can be hooked up to sensors which can be linked to the local relay and up to 16 remote relays, so that a change in sensor status can effectively drive multiple remote relays. For instance, a premise detection alert could lock down 9 doors and set off 9 sirens across a campus.

Virtual Relays.

uSwitchPro supports Virtual uSwitch control. With the creation of either virtual buttons, using local GPIOs or linking the button assigned to one of the two local relays up to eight (8) additional remote uSwitches can be driven by touch of a single button or by the state of one of the GPIO inputs .

Power Supply Connection

Connect an appropriate DC power supply to the **Vin+** and **Gnd** Terminals as shown below (regulated power supply recommended). The power supply should be rated to meet the operating current of uSwitch (specified in Appendix B).

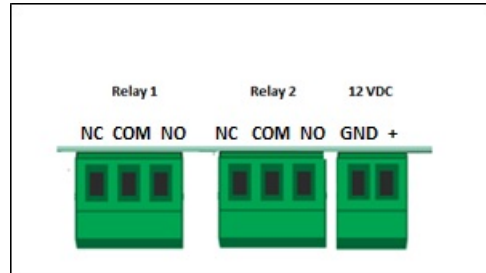

Relay Connection

When connecting to the relay contacts make sure any current or future load will not exceed the load ratings for the relays (per spec. in Appendix B).

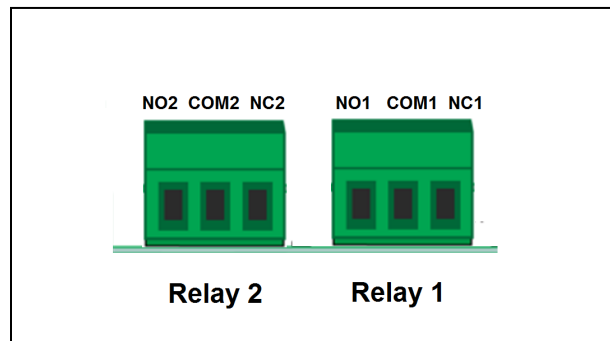

Network Connection

Connect the uSwitch Ethernet port to a 10 Base-T or 100 Base-T switch, router or cell modem/gateway (per diagram below). For configuration, uSwitch can also connect directly to the Ethernet port on a computer using a crossover/null-modem cable. Otherwise, for connection through standard communication equipment a straight cable should be used.

For uSwitchPoE the Ethernet cable should be connected to the UPLINK port on the far left, and the supplied mini Cat 5 Ethernet cable should be connected between the "uLink In" and PoE port 1.

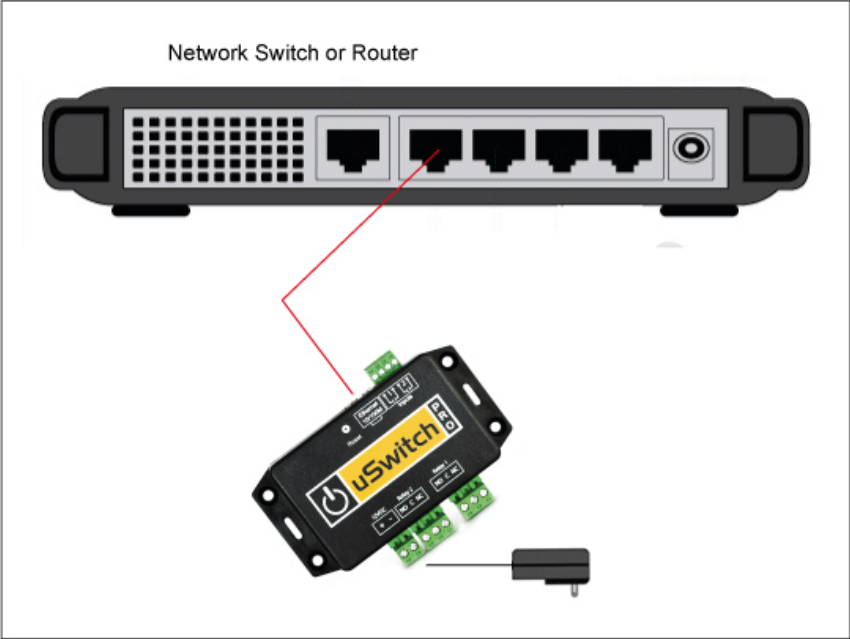

Control Center – Home Page

uSwitch and uSwitchPro

This is the main control and interface of uSwitch, called the “uSwitch Control Center”. The Control Center appears when the IP address or URL assigned to a uSwitch is entered into a browser that has access to this network. The “Control Center” provides manual relay control and status information based on the various operating modes and inputs (see operating modes in uSwitch Control Center Operating Modes section). Navigating between the uSwitch features is done by clicking on the blue menu buttons on the left side of any uSwitch page. The menu options for the uSwitch are, **uSwitch Control Center, Relay Configuration, Watchdog Configuration, GPIO Configuration, Virtual Relay Configuration, Network Configuration, Authorization Configuration, Operations Manual**. There are two levels of user operation. The Control Center home screen is accessible to anyone with the user name and password for user Control. Configuration menus are only accessible to privileged users with a configuration level password (default is ‘admin’).

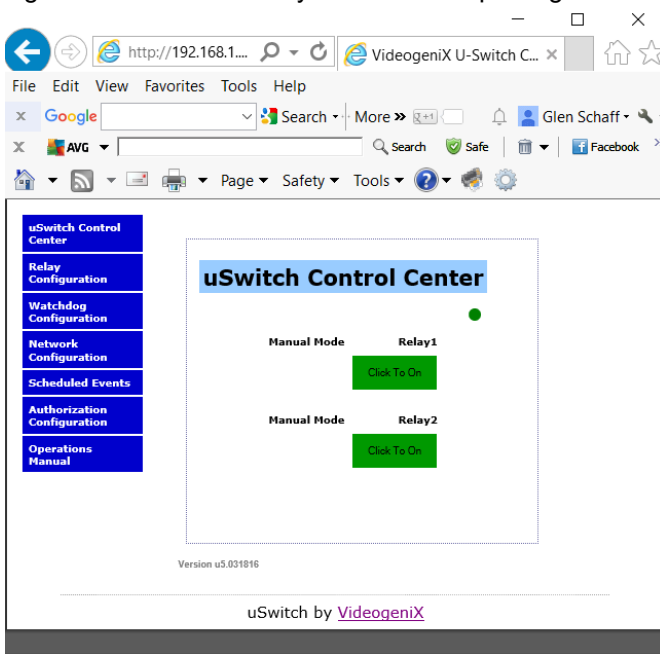

uSwitch/uSwitchPoE

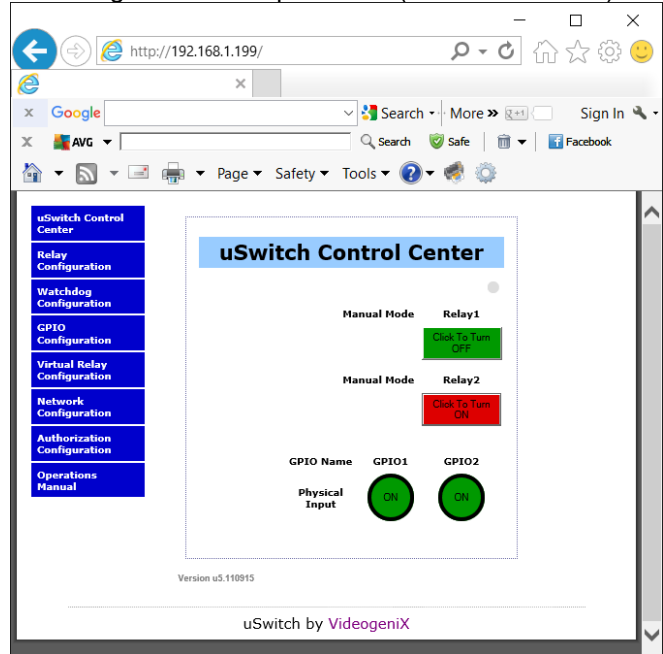

uSwitch Pro

Default Control for uSwitch and uSwitchPoE

Selecting the red “Click to Turn ON” button on the “Control Center” page for a relay, energizes the selected relay forcing a normally closed (NC) contact to open or a normally open (NO) contact to close. The button’s color will simultaneously change from green to red (unless these colors have been changed by the user from the Relay Configuration menu) and the button’s text will change to “Click to Turn OFF” (unless “user assigned text” has been similarly modified).

“Relay1” and “Relay2” are factory default names assigned to the relays on uSwitch and uSwitchPro. Relay names can be changed by the user from the Relay Configuration page (for example, “Front Door”, “Stair Lights”, “Siren” etc.)

As shown on the right above, The Control Center for uSwitchPro also provides the states of the inputs (GPIO1 and GPIO2 in a round icon). GPIO1 and GPIO2 are default names assigned to these inputs. Custom colors, names, and state text for the GPIOs are assigned from the GPIO Configuration Page.

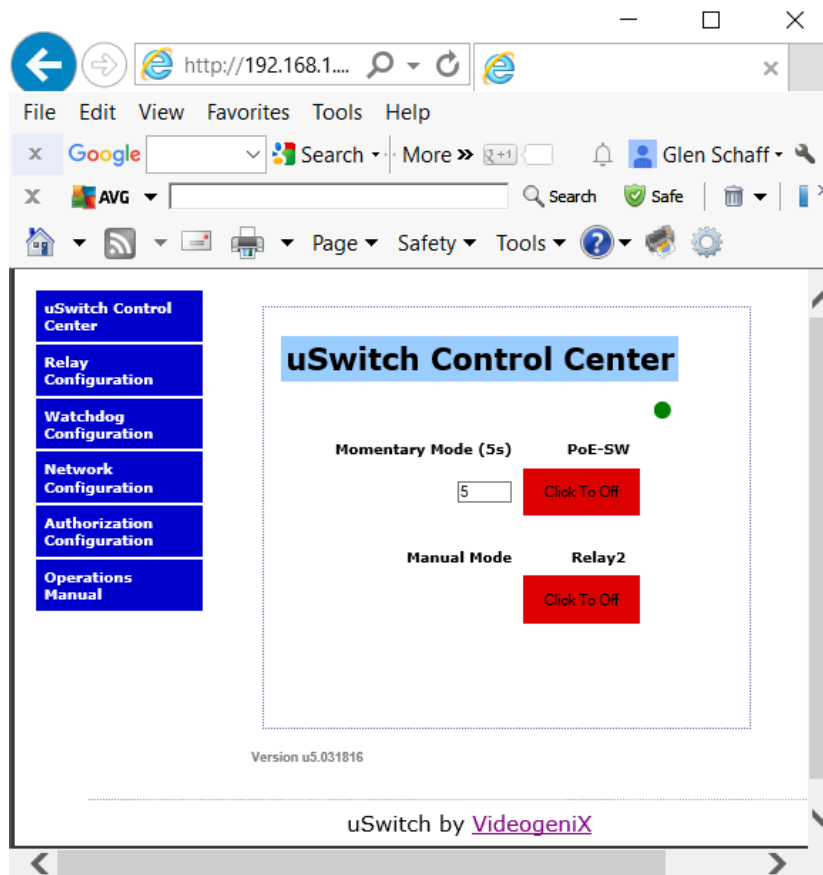

Default Control Center for uSwitch PoE

Selecting the red “Click to Turn ON” button on the PoE-SW relay will force the following PoE Reset confirmation screen.

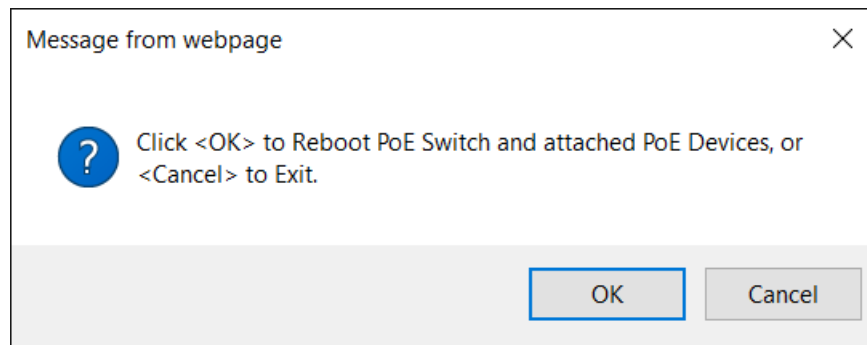

This message screen protects the user from unintentionally rebooting the PoE switch and at the same time allows it if it intentional. Relay 2, functions exactly as the standard relay for uSwitch/uSwitchPro.

Menu Navigation

Navigating between the uSwitch configuration menus is done by clicking on the blue menu buttons on the left side of every page (each configuration page has the identical menu choices available). The menu options for the uSwitch and uSwitchPoE are, **uSwitch Control Center**, **Relay Configuration**, **Watchdog Configuration**, **Network Configuration**, **Scheduled Events**, **Authorization Configuration** and **Operations Manual** (the Operations Manual is only available when an outside web connection is available). Clicking on a configuration menu the first time will require an administrator level password, (the default administrator password is “admin”). **The menu for uSwitch Pro is the same but also has GPIO Configuration, Virtual Relay Configuration, to configure the general purpose digital inputs and to set up virtual buttons or controls for other uSwitch Relays on the network.**

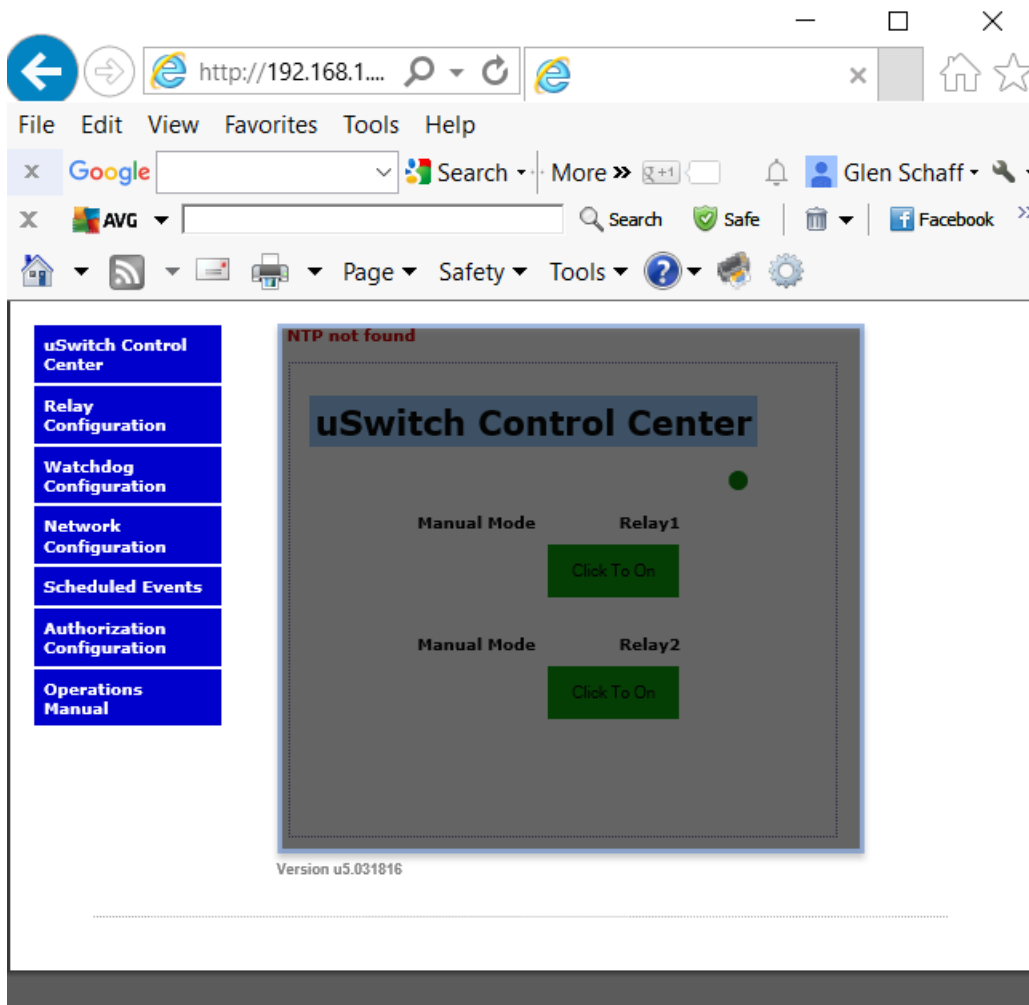

uSwitch Control Center Operating Modes

Control Center (Relay 1- Resettable-Momentary Mode)

The image below shows the Control Center with relay one configured as a twenty (20) second resettable-momentary relay (a relay is configured into momentary mode from the Relay Configuration page). In this case clicking the relay 1 button will force it to change state, count down to zero (currently 16) and then return to its initial state. Clicking the relay control button during the countdown phase resets the timer but the state of the relay does not return to the initial state until the countdown completes. Setting the initial state of a momentary relay sets the state the relay is in prior to being clicked. Therefore it is recommended to set Momentary relays to a startup state of “on” or “off”. Setting to “last” increases the flexibility, but can result in unplanned behavior. Note: during countdown mode the colors of the relay flash between its current state and yellow.

“Warning” if the uSwitch is behind a device which provides the uSwitch’s connection to the network and at the same time a relay on the uSwitch is used to power on and off that device, then that relay must always be in either momentary mode or “Ping Auto Reboot” mode. Otherwise turning power off on that device by the uSwitch will disconnect the uSwitch from the network. It cannot be reconnected because the device sourcing the uSwitch’s network connection is turned off. This mechanism could be used to permanently firewall a network. By powering down a network gateway and the connection could only be re-established by someone with physical access to the network. (MARIO READ THIS).

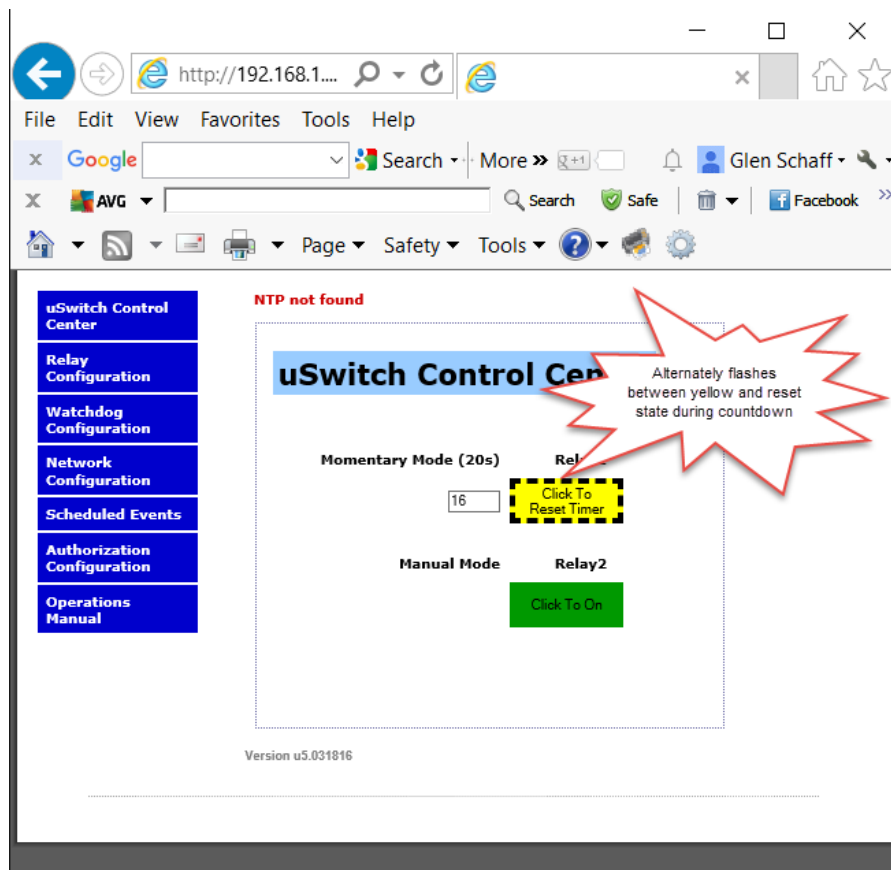

Control Center (Relay1 Watchdog Mode, Startup Delay phase)

The image below shows the Control Center with relay1 configured in Watchdog/“Ping Auto Reboot” mode (a relay is placed in watchdog mode from the Relay Configuration page)..A grayed out relay button indicates manual control is disabled when watchdog mode has been turned on. Whenever a relay is in watchdog mode it cannot be manually controlled by a push button (however there is a watchdog over-ride from the relay configuration screen). The image below

shows Relay1 in Watchdog mode. On the screen below the watchdog feature has started the initial startup countdown specified by the startup delay entry before testing for connectivity, currently 1 min, 33 seconds remain before Watchdog mode becomes fully active. A minimum recommended startup countdown time of five minutes (300 seconds) is recommended which would allow slow connecting devices time to reconnect to the network before the uSwitch begins testing for connection.

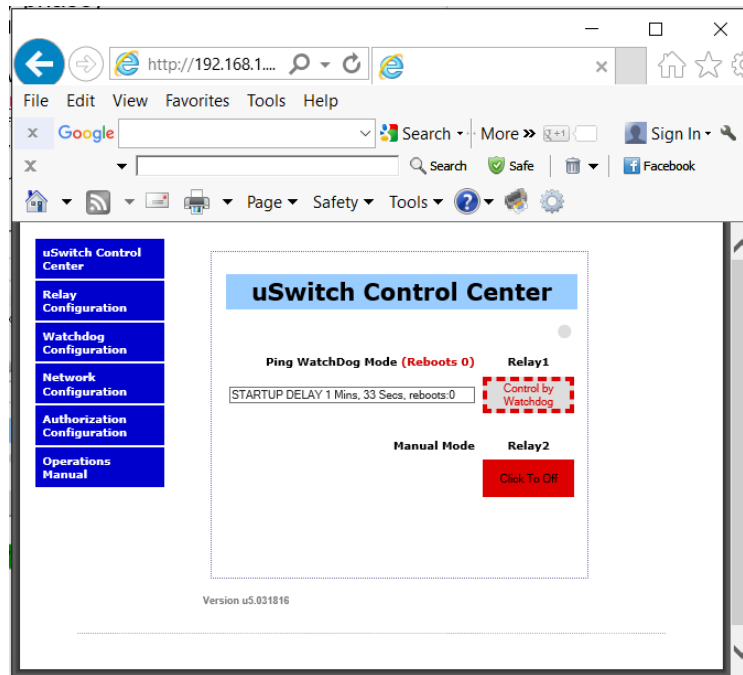

Control Center (PoE-SW Watchdog Mode, Startup Delay phase)The image below shows the Control Center for a uSwitch PoE in Startup Delay mode. A grayed out relay button indicates manual control is disabled when uSwitchPoE is in Watchdog mode. When the uSwitchPoE is in watchdog mode it cannot be manually controlled by a push button (however there is a watchdog over-ride from the relay configuration screen). On the screen below the watchdog feature has started the initial startup countdown specified by the startup delay entry before testing for connectivity, currently 10 seconds remain before Watchdog mode becomes fully active. The comment (Reboots 182) represents the total number of times the uSwitch has rebooted the PoE Switch since it was first put online, or reset last. The “reboots:2” in the current mode box, represents the total number of reboots in the current watchdog cycle. When the number of reboots reaches “max reboot attempts”, (specified by the Watchdog configuration menu) the PoE-SW circuit will go into fault mode. After fault mode times out (based on configuration specified in “period before retry on fault”) , the uSwitch will return to the normal mode of testing URLs and or IP addresses by pinging them for connectivity.

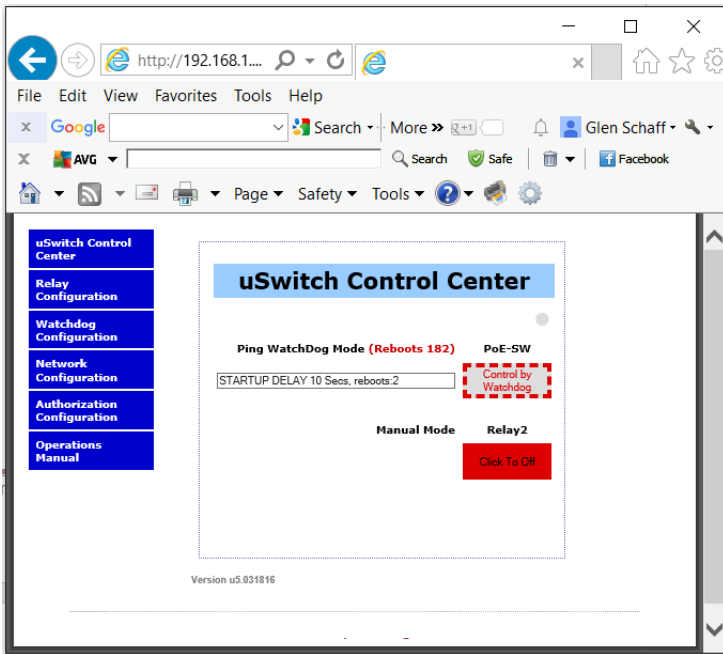

Control Center (Relay1 Watchdog Mode, Ping Delay phase)

The image below shows the Control Center with Relay 1 configured in Watchdog Mode, during the, “Ping Delay” phase. The Ping Delay Phase is the time between successive pings to the same URL. A recommended time of 90 seconds for the “ping delay” setting is suggested. Note: During Watchdog mode manual push-button relay control is disabled so the relay control button is grayed out.

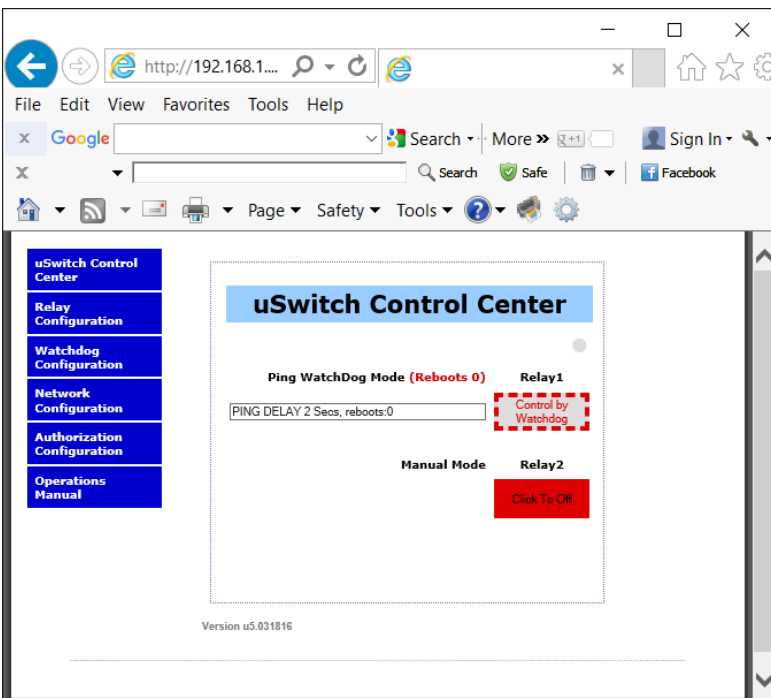

Control Center (Relay1 Watchdog Mode, pinging phase)

The image below shows the Control Center with Relay1 configured in Watchdog Mode. In this instance the uSwitch is attempting to ping the URL “yahoo.com” assigned for Relay 1 to determine if Relay 1 needs to be cycled. Also, note this is the 1st attempt to communicate with the URL.

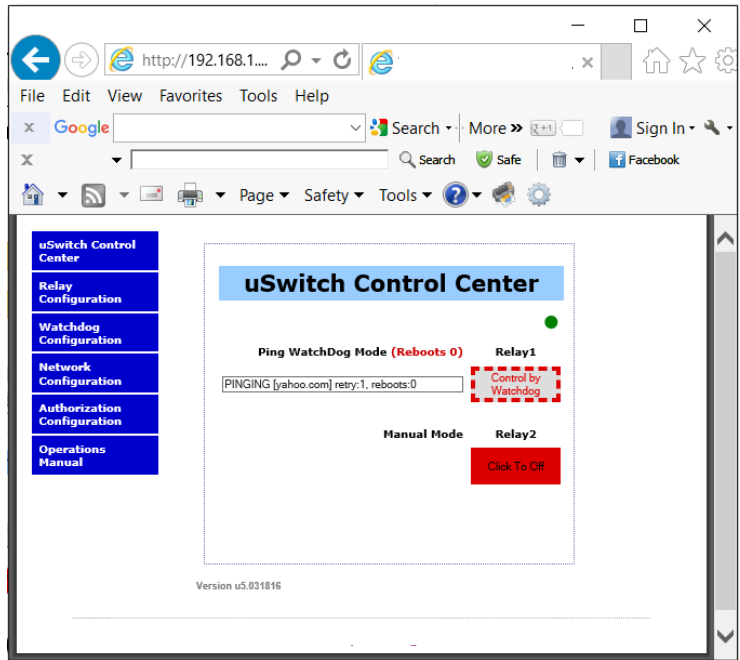

Control Center (PoE-SW Watchdog Mode, ping phase)

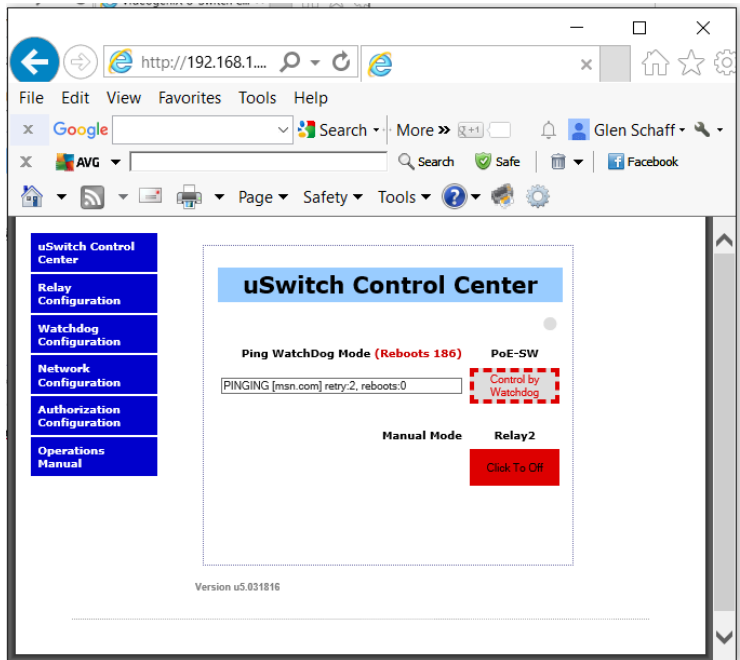

Control Center (Relay1 Watchdog Mode, auto reboot countdown phase)

The image below shows the Control Center with Relay1 configured in Watchdog Mode. The uSwitch automatically is cycling the relay after failing to get responses from the URLs specified by the user on the Watchdog Configuration page for Relay1. The screen shot below shows the reboot countdown time remaining and will turn power back on to device when the countdown reaches 0. The amount of time for the relay to be cycled is as specified in the “Relay Cycle Time” field on the Watchdog Configuration page. After a reboot of the device the Watchdog will again initiate a startup delay countdown and hold off communication tests until the device Startup period completes.

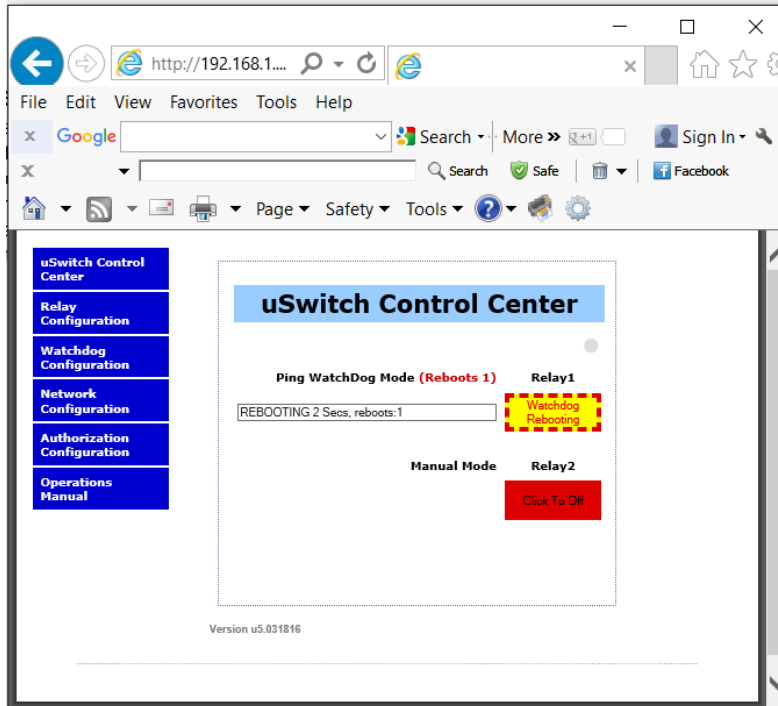

Control Center (Relay1 Watchdog Mode, Fault Mode)

The image below shows the Control Center with Relay1 configured in Watchdog Mode. The uSwitch goes into Watchdog “Fault Mode” after the number of consecutive reboot attempts exceeds the user specified “Max Reboot Attempts”. The screen shot below shows the uSwitch has attempted three consecutive reboots without success. The amount of time left in Fault Mode is 1 hour 46 Mins, 11 Secs. After the Fault Mode counts down to 0, the Watchdog will again initiate normal operation. The purpose of fault mode is after so many consecutive failures the uSwitch discontinue rebooting the device for a specified amount of time before restarting reboot attempts. This prevents continuously rebooting a device that may be working fine and the failure is elsewhere on the network. If at any time during “Fault Mode” the uSwitch determines the device is again operating normally the uSwitch will exit “Fault Mode” and transition back into normal Watchdog mode.

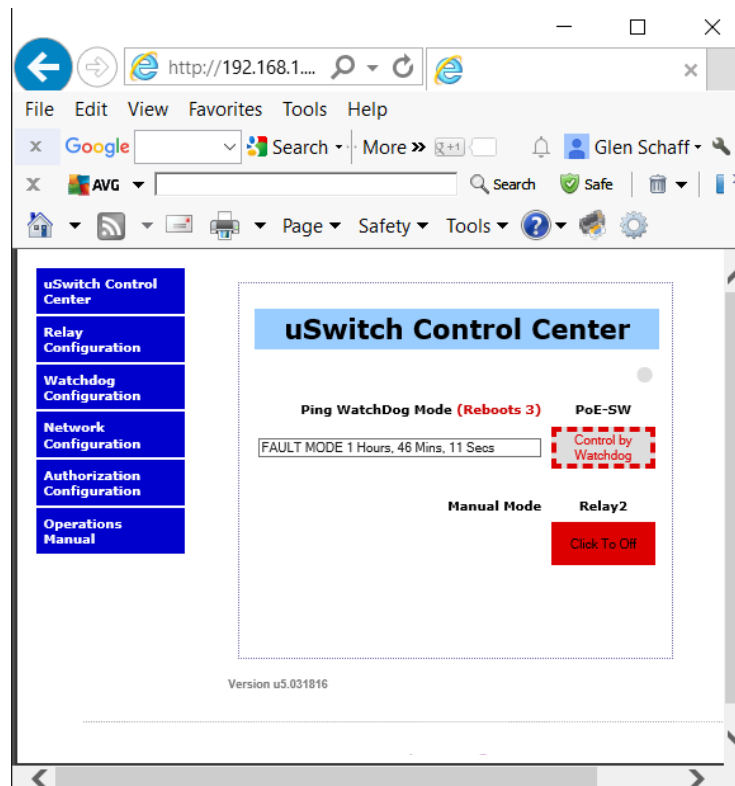

Control Center (GPIO1 with counter enabled)

The image below shows the Control Center with relay1 configured in Watchdog Mode and GPIO1 configured with the “Enable Counting” field checked (if counting is not enabled the running count field and counter reset are not present on this screen). The value 119 in the “Running Count” field means, since the counter starting counting or was last reset by the “Clear Counter” button (directly below), 119 full input state transitions have occurred on GPIO1. Clicking the Reset button clears the counter.

The screenshot shows a web browser window displaying the uSwitch Control Center interface. The browser's address bar shows the URL `http://192.168.1.199/index.htm`. The page features a navigation menu on the left with the following items: uSwitch Control Center, Relay Configuration, Watchdog Configuration, GPIO Configuration, Virtual Relay Configuration, Network Configuration, Authorization Configuration, and Operations Manual. The main content area is titled "uSwitch Control Center" and includes the following controls:

- Ping WatchDog Mode:** A text input field for "STARTUP DELAY" is set to "112 Secs".
- Relay1:** A button labeled "Control by Watchdog".
- Manual Mode:** A green button labeled "Click To Turn OFF".
- GPIO Status:** Two circular indicators for "GPIO1" and "GPIO2", both showing "ON".
- Running Count:** A text input field showing the value "119".
- Reset:** A button labeled "Clear Counter".

At the bottom left of the interface, the text "Version u5.110915" is displayed.

Network Configuration Page

Network settings and control options are modified from the Network Configuration page. If multiple uSwitch devices are used on the same network, connect only one at a time and change the IP address of each uSwitch before connecting the next uSwitch to the network. This prevents having two network devices on the same network with identical network addresses (creating an IP address conflict). You may need to clear the Address Resolution Protocol Cache (ARP) each time you swap uSwitch units on the same network. This is because each uSwitch has a factory default IP address (192.168.1.199) and if the cache is not cleared an IP address conflict could occur if two IP addresses are associated with two different hardware MAC addresses from two different devices (each uSwitch has a unique MAC address). To clear the ARP cache on a Windows PC type "arp -d inet addr" in a DOS/Windows command prompt window ("arp -d -a" as super user on Apple OSX). After changing network properties such as IP address it can take up to a few minutes before all devices on the network can talk to a uSwitch

You can use a proxy server to connect multiple uSwitch devices to an outside network or the internet by using a single static or dynamic IP resolved address. This can be done using most consumer/ industrial grade routers. If a proxy server environment is to be set up, each uSwitch will not be accessible from the internet until the proxy server (router) is configured with the unique and specific port number and IP address assigned to each uSwitch on the router's local area network (LAN). This is a form of Network Address Translation (NAT) also called port forwarding or virtual port addressing. To determine how to set up the proxy server for port forwarding (also called NAT) review the manual for the network device which will act as the proxy server and as the gateway to other networks.

(Note: When multiple uSwitch devices are installed on the same local area network, each must have its own unique 'LAN' IP address. Every uSwitch comes with a factory default IP address of 192.168.1.199. If multiple uSwitch devices are used, assign a unique IP address to each, such as: 192.168.1.195, 192.168.1.196, 192.168.1.197, etc.). The following Network Control Page shows the factory settings on the standard uSwitch and uSwitch products.

Network Configuration	
uSwitch Control Center	Host Name <input type="text" value="USWITCHPRO"/>
Relay Configuration	Enable DHCP <input type="checkbox"/>
GPIO Configuration	IP Address <input type="text" value="192.168.1.199"/>
	Gateway <input type="text" value="192.168.1.1"/>
Virtual Relay Configuration	Subnet Mask <input type="text" value="255.255.255.0"/>
	HTTP Port <input type="text" value="80"/>
Watchdog Configuration	TCP Port <input type="text" value="9780"/>
	Primary DNS <input type="text" value="8.8.4.4"/>
Network Configuration	Secondary DNS <input type="text" value="8.8.8.8"/>
	Auto Discovery <input checked="" type="checkbox"/>
Scheduled Events	Primary NTP <input type="text" value="time-c.nist.gov"/>
	Secondary NTP <input type="text" value="time-a.nist.gov"/>
Authorization Configuration	Time Zone <input type="text" value="EST GMT -5:00"/>
	Daylight Savings <input checked="" type="checkbox"/>
Operations Manual	MAC Address <input type="text" value="<70:B3:D5:73:06:22>"/>

Save Configuration Changes Restore Factory Defaults

Host Name

This configurable field represents a user chosen name for your uSwitch. It will be used when reporting information from this device and in any status logs. It is a virtual name for the current uSwitch device.

Enable DHCP

This check box should be selected when the user chooses to have a DHCP server automatically assign IPV4 addresses to the uSwitch. DHCP is not recommended as DHCP assigned addresses are subject to change making it difficult to permanently access a uSwitch whose address could change at random points in time. (WARNING: DHCP is supported primarily as a setup/initial connection tool. Leaving a remote device in DHCP can result in a loss of remote connect ability should the DHCP server re-assign the uSwitch's IP address)

IP Address

This specifies the unique IPV4 address of the uSwitch on the LAN. (Each uSwitch is factory configured with the default static IPV4 address of 192.168.1.199). This static LAN address should be modified to be consistent with the LAN's subnet on which it is to be installed. When using multiple uSwitch devices on the same LAN each uSwitch must have a unique IPV4 address.

Gateway

This specifies the IP address of the gateway (typically router/cell modem) which is responsible for creating the LAN and connecting to other networks and or the WEB. If unknown, the Gateway address can be obtained from the network administrator. The Gateway is the LAN address of the device that routes the internal LAN to an outside network (WAN) or other networks. The factory default gateway setting for the uSwitch is 192.168.1.1. This must be the assigned address of the device that routes the network on which the uSwitch is connected for uSwitch features to function correctly. For instance, pinging devices that are outside the local area network when Auto Reboot mode is enabled will not work if the correct Gateway address is not assigned..

Subnet Mask

The subnet mask identifies a specific LAN's private addressing scheme on a TCP IPV4 network. The network's subnet mask can typically be obtained from the network administrator. The uSwitch default subnet mask is set to 255.255.255.0. Each of these four, three-digit fields represent an IPV4 address field. Each of these fields represents a byte worth of addressing (1-255). Any bit positions in the address with a value of zero are accessible on the local subnet. Any bit positions with a value of 1 are fixed (unchangeable) on the local subnet. In the subnet mask, 255.255.255.0, the first three IP byte address fields are fixed and the last byte field may vary from 1 to 255 (a value of 255 is equivalent to 11111111 in binary).

HTTP Port

This specifies the HTTP port (for typical WEB access) used for outside communications to the uSwitch. By default, this port is set to 80 (standard access port for HTTP devices). A unique port is required for each uSwitch or other such device that is going to be accessed using a port address from outside the local network. In this case, each uSwitch device on the same local area network would be assigned a different port (for example 41, 42, 43, etc). (Two network devices on the same LAN should never be assigned the same port address). With unique ports assigned to a uSwitch, a router can forward all outside communication for a given device directly to a specific uSwitch without the outside network having any internal knowledge of the addressing scheme on the LAN beyond the address of the gateway to the LAN and the virtual port number (private IPV4 addresses are not accessible to the outside world/cloud). Each uSwitch is then accessed from the cloud on its private network by entering the routable/resolvable IP address of the gateway and the specific port assigned to the uSwitch™. Any port (besides port 80) assigned to a uSwitch™ requires all outside communications to that uSwitch to reference it via its assigned port. For instance, www.uhavecontrol.com:42 (for a device on port 42) or www.MyHomeRouter:41.

TCP Port

This specifies the TCP port for any internal or external TCP commands to the uSwitch used for outside communications to the uSwitch. By default, this port is set to 9760 (standard port for TCP). This port does not need to be changed unless your remote device specifies a port other than 9760 to this device IP address or if multiple uSwitches on the same subnet are to be accessed via TCP from outside the network using only port numbers. With unique ports assigned to a uSwitch, a router can forward all outside communication for a given device directly to a specific uSwitch without the outside network having any internal knowledge of the addressing scheme on the LAN beyond the address of the gateway to the LAN and the virtual port number (private IPV4 addresses are not accessible to the outside world/cloud). Each uSwitch is

then accessed from the cloud on its private network by entering the routable/resolvable IP address of the gateway and the specific port assigned to the uSwitch™.

Primary DNS

This field is used by the uSwitch to resolve outside URLs that may be included in the automatic reboot options or device firmware whose actual IP addresses are unknown inside the LAN.

Secondary DNS

This secondary DNS (Domain Name Server) is used by the uSwitch to resolve outside URLs that may be included in the automatic reboot options or device firmware whose actual IP addresses are unknown from the private network just in case the primary DNS is not available.

Auto Discovery

This checkbox should only be checked if you want to enable auto discovery of a uSwitch on a network. In this mode a uSwitch periodically announces its presence on the network. To hide the uSwitch or silence it and diminish unnecessary network traffic this checkbox should be unchecked. The default value is checked.

Primary NTP

Address of an Network Time Protocol Server that the uSwitch will synchronize its schedule to.

Secondary NTP

Address of a backup Network Time Protocol Server that the uSwitch will synchronize its schedule to.

Time Zone

Time zone for the area where they unit will be programmed from. The times in the schedule are effective based on this time zone.

Daylight Savings

This box should be checked during daylight savings time. It effectively adds one hour to the GMT time provided by NTP servers which do not account for Daylight savings.

MAC Address

This is the physical address permanently assigned a given uSwitch. It cannot be modified however it can be used to verify which LAN IP address is connected to which uSwitch by executing either an arp -a command (from a windows computer in a DOS or command window), or when running the uSwitch discovery utility.

[MAC Address](#)

<40:D8:55:16:3E:00>

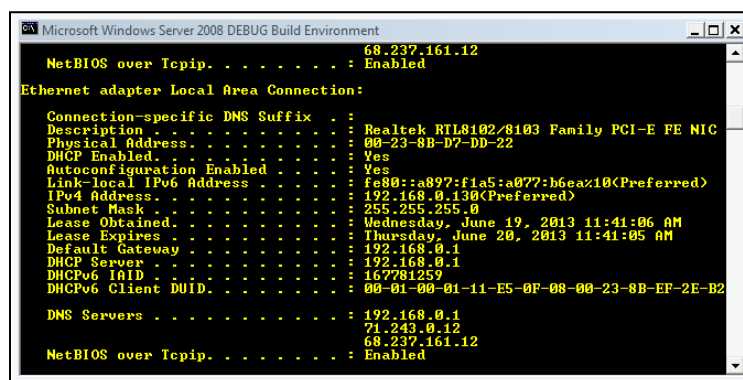

```
Microsoft Windows Server 2008 DEBUG Build Environment
NetBIOS over Tcpip. . . . . : 68.237.161.12
                           : Enabled

Ethernet adapter Local Area Connection:

   Connection-specific DNS Suffix  . : 
   Description . . . . .           : Realtek RTL8102/8103 Family PCI-E FE NIC
   Physical Address. . . . .       : 00-23-8B-D7-DD-22
   DHCP Enabled. . . . .          : Yes
   Autoconfiguration Enabled . . . : Yes
   Link-local IPv6 Address . . . . .: fe80::a897:f1a5:a077:b6ea%10(Preferred)
   IPv4 Address. . . . .           : 192.168.0.130(Preferred)
   Subnet Mask . . . . .           : 255.255.255.0
   Lease Obtained. . . . .         : Wednesday, June 19, 2013 11:41:06 AM
   Lease Expires . . . . .         : Thursday, June 20, 2013 11:41:05 AM
   Default Gateway . . . . .       : 192.168.0.1
   DHCP Server . . . . .           : 192.168.0.1
   DHCPv6 IAID . . . . .          : 167781259
   DHCPv6 Client DUID. . . . .    : 00-01-00-01-11-E5-0F-08-00-23-8B-EF-2E-B2

   DNS Servers . . . . .           : 192.168.0.1
                                       71.243.0.12
                                       68.237.161.12
   NetBIOS over Tcpip. . . . .    : Enabled
```

To access a uSwitch remotely from an outside network, WAN or the internet you will need to set up port forwarding (also called NAT or Virtual Port addressing) on your router or gateway. You can set this up from your router's configuration page as follows:

1. Assign a specific and unique port to each uSwitch from the Network Configuration page of the uSwitch.
2. Find the Port Forwarding/Virtual Server/NAT configuration in your router and specify the unique port number assigned to each uSwitch (from the network configuration page) along with each uSwitch's private IP address assigned in the step above (make sure that any uSwitch is outside the DHCP range of the router).
3. Make sure the Gateway is set up to point to the router.
4. After enabling port forwarding from the router cycle power on the uSwitch with the forwarded port so the router establishes the new route to the uSwitch via the port.
5. If you are on a static IP line you may use a 3rd Party free DDNS provider to register a Domain Name for your Router (URL). Map your router to the free DDNS provider selected.
6. If the address assigned to your router by your ISP is dynamic (changes regularly) than you will need to set up the dynamic DNS page of your router to map the URL to a Dynamic IP Name Server (consult your router's user configuration manual).
7. Browse to your USwitch using the following protocol from a browser; <http://myNetworksURL:myuSwitchPortNumber> (i.e. <http://myHomeRouter:8000>)

Relay Configuration Page

The Relay Configuration allows a user to customize how each relay is displayed, controlled and any configure startup features. The Relay Configuration Page also provides an extra menu option at the bottom titled “Force Watchdog Reboot”. This page is only accessible from within the Relay Configuration page. It allows a user to bypass the Watchdog Cycle and force an immediate reboot of a device that is in Watchdog mode. In auto Reboot mode the user cannot force the relay output to change states from the uSwitch Control Center because the Watchdog is in control of the Relay. Placing access to this control option within a configuration level menu prevents users without higher level passwords to reset a device and bypass the watchdog.

Relay Configuration Page for uSwitchPro

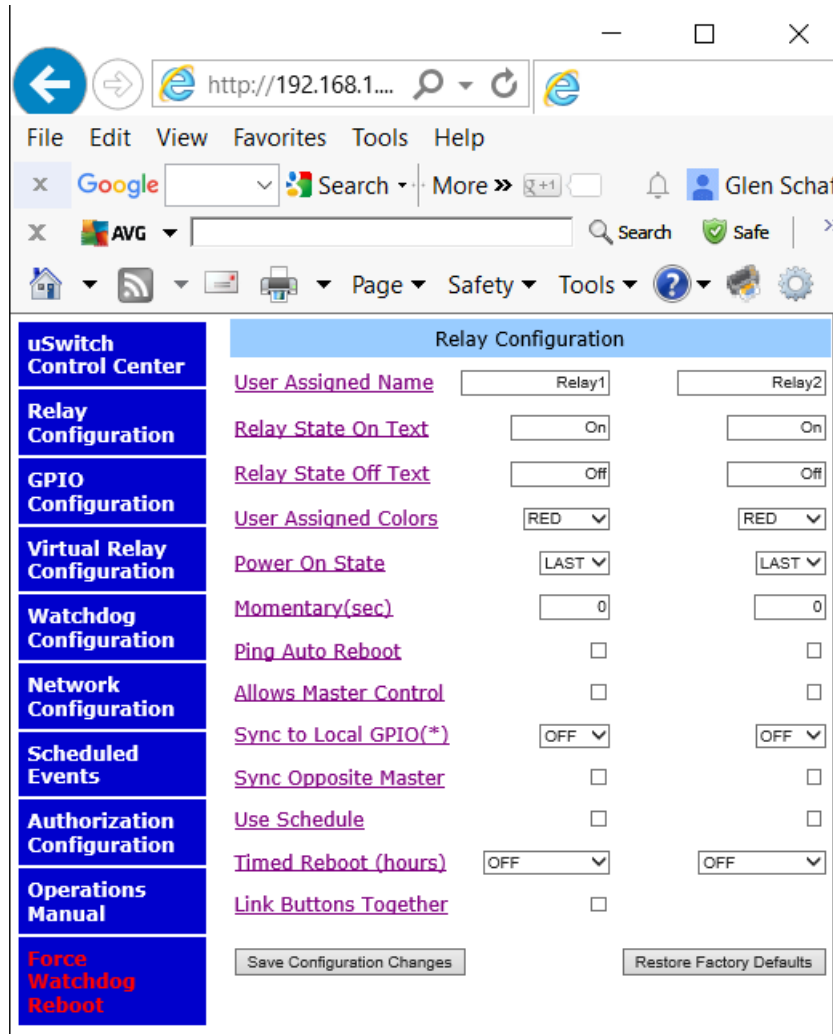

Relay Configuration Page for uSwitch

User Assigned Names

These two configurable fields represent user assigned names for each relay. Once modified all text identifying “Relay1” or “Relay2” from the browser interface will be displayed with customer assigned names. Factory default names are Relay1 and Relay2. **For uSwitchPoe the default name for the relay-switch on the PoE ports is “PoE-SW”.**

Relay State On Text

This field specifies the text assigned to the relay button to be displayed when it is in the “On” state.

Relay State Off Text

This field specifies the text assigned to the relay button to be displayed when it is in the “Off” state.

User Assigned Colors

This field specifies which color is assigned to a relay for a given state. The choices are “RED/GREEN” or “GREEN/RED”. The colors may indicate different states depending on the physical wiring to the uSwitch.

Power On State

This dropdown box configures the initial power on state of the relay when a uSwitch is first turned on. The options are OFF, ON and LAST. **(In Watchdog Mode the Relay Power On State Must be Programmed to “OFF”), for uSwitchPoe this field is locked to OFF on relay 1. If the relay were energized on Power on and if the uSwitch was wired through the PoE switch than the uSwitch could never receive a command from the network and therefore the PoE switch would never turn on.**

1. OFF - Relay is not energized on uSwitch power up
2. ON - Relay is energized on uSwitch power up..
3. LAST - Relay is put in the state it was in when on uSwitch power up.

This dropdown box configures the initial power on state of the relay when a uSwitch is first turned on. The options are

Momentary (sec)

This timer field puts a relay into momentary (pulse) mode. When Momentary is set to zero, the relay is latching. Clicking on the relay’s control changes its state to the opposite state leaving it in that state (latched) indefinitely. A non-zero value in the **Momentary** field puts the relay in momentary/pulse mode. In this mode, each time the relay is clicked it changes its state and retains in the new state for the number of seconds specified in the Momentary field. After the second counter (on the display for the relay) elapses the relay returns to its original state. (Note, if wiring a uSwitch in parallel with another physical momentary switch, such as a garage door opener, the relay must be put into momentary/pulse mode. If not whenever uSwitch relay is closed the pre-existing switch will have its functionality blocked). . When a Momentary Relay is clicked the relay state changes to the opposing state. Clicking the relay again resets the counter, the relay only returns to its original state after the countdown expires. Similarly if a momentary relay is set up as a slave to a remote uSwitch once it changes state it will start counting down, any new messages received prior to completing the countdown will reset the timer without returning to the original state. Only when the countdown reaches 0 will the relay return to its default state.

For uSwitchPoE the factory default for the Relay assigned to PoE power is “momentary” with a value of 5 seconds. This relay can be configured to either a momentary or AutoReboot mode (no other options are possible). This is because if the PoE switch was ever powered off and the uSwitch was wired through the same PoE switch to the network than the uSwitch could never receive another command from the network because all communication has to go through the PoE switch (which would then not have power) and therefore a completed communication lock-out could occur.

Ping Auto Reboot

When checked the selected relay will act as an automatic watchdog reboot device and its state will be automatically controlled as specified in the settings from the **Watchdog Configuration** page. Like momentary mode, watchdog mode, is mutually exclusive). Manual operation of the relay is disabled in Watchdog mode. **(In Ping Auto Reboot Mode the Power on State Must be Programmed to “OFF”).**

Allows Master Control (applies to uSwitch and uSwitchPro)

When **Allows Master Control** is checked the selected relay forfeits local control and only a remote uSwitch’s GPIO, or virtual input can control the relay. When a remote uSwitchPro is programmed to control this relay (on remote uSwitchPro’s GPIO Configuration page) the state of the relay will synchronize to the GPIO (input) from the remote uSwitchPro. This enables a remote uSwitch virtual input or remote GPIO to sync multiple devices such as door locks on a campus from a

single action or uSwitch. uSwitchPros can be set up to remotely control a relay on a standard or Pro uSwitch. This mode is mutually exclusive to other modes that are locally controlled.

Timed Reboot

The “Timed Reboot” field can be programmed to either OFF, 12, 24, 36, or 48 hours. In Timed Reboot mode the relays will automatically change their state after the specified time period expires and then return to its original state after the number of seconds specified in the momentary field. A value must be specified in the momentary field because Timed Reboots are always momentary. (there is also a test option for 30 seconds, since it is unreasonable to wait for 12 hours to test this feature. Timed reboots are intended to be used as a secondary reset strategy.

Sync to Local GPIO

This pulldown menu ties the respective relay to the respective GPIO. The choices are “OFF, ANY, LOW, HIGH”. If “OFF” is not selected than the state of the relay will synchronize with the specified state of the GPIO. When ANY is specified the Relays output changes state with every state change of the GPIO. When LOW is specified the Relay will always track when the GPIO goes LOW however the relay remains under manual control if the GPIO state is HIGH. When HIGH is specified the Relay will always track when the GPIO goes HIGH however the relay remains under manual control if the GPIO state is LOW. The relay will either be in the same state as the GPIO when it is tracking or the opposite state of the GPIO depending on the “Sync Inverts GPIO” field.

Sync Opposite Master

If this field is not checked and Sync to Local GPIO is not set to “OFF” the relay state will match whatever the GPIO state is when it is synchronizing. If “Sync Opposite Master is not checked and Sync to Local GPIO is anything but “OFF” the Relay state will be the opposite state of the GPIO. The same applies when this is synched to a remote relay. Sync Opposite Master will force this relay to be the inverted state of the command from the master control uSwitch.

Use Schedule

When use schedule is checked the relay operation will follow the setup in the schedule. A weekly operational schedule can be set up from the “schedule events” menu

Link Buttons Together

This checkbox is used to assign all the properties for button 1 to button 2 and link them together. When relay buttons are linked, whenever Button1 is manually pushed both relays transition their states simultaneously (note: depending on the initial states they can both transition to the same state or opposite states). If timer mode is specified along with linking, both buttons use Relay1’s timing options.

Special Operating Mode for uSwitch PoE relay only: The configuration settings for the relay dedicated to the PoE switch is different than the two general purpose relays on a standard uSwitch or uSwitch Pro. The first relay on a uSwitch PoE defaults to momentary mode. Which will allow a user to cycle the relay and reset the uSwitch PoE manually. You may also put a uSwitch PoE into Watchdog mode which will assign the uSwitch PoE as a momentary Relay (time being “Relay Cycle Time” from Watchdog Configuration Page). The uSwitch PoE can never be set up as a latching (non-momentary) relay. Doing so could render the PoE switch and uSwitch completely inaccessible. This would happen if the uSwitch was behind the PoE switch and the user set the relay to a state that disconnected power to the uSwitch by latching power off on the PoE switch. Since the uSwitch is behind the PoE switch which is now latched off it could never be accessed again and therefore power could not be turned back on to the PoE switch. For this reason the relay assigned to the PoE switch can only be operated in a momentary configuration.

Force Watchdog Reboot

This Page is accessible only from the menu on the Relay Configuration page. It enables a user to force a Relay in “Ping-Auto-Reboot Mode” to cycle power regardless of where it is in the auto-reboot cycle. Only users with privileges to access the Relay Configuration page will be able to force a Watchdog Relay Reboot. The screen brings up all relays and enables the user to click on any relay and force a reboot if in Ping-Auto-Reboot mode. However certain relay configurations or states still will not allow the relay to be forced to a different state (i.e. relays that are synced to a GPIO, slaves to another uSwitch, or in Ping-Auto-Reboot mode during a Reboot).

Force Watchdog Reboot Page

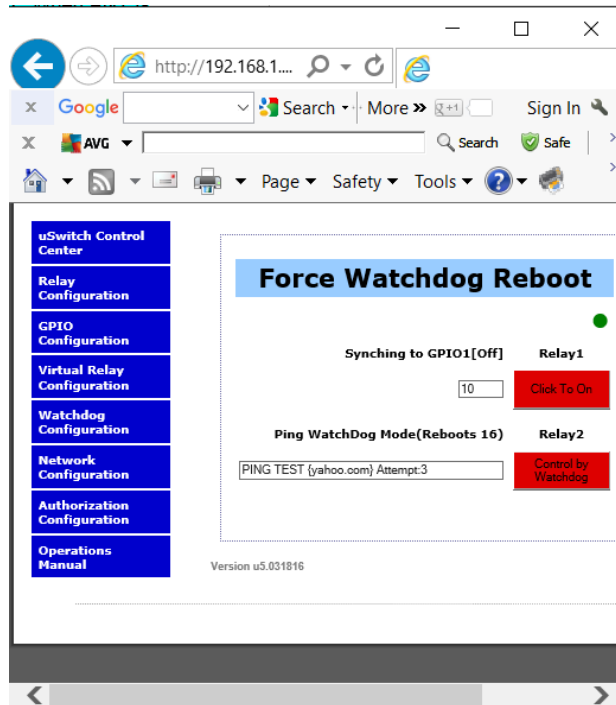

GPIO Configuration Page (uSwitchPro only)

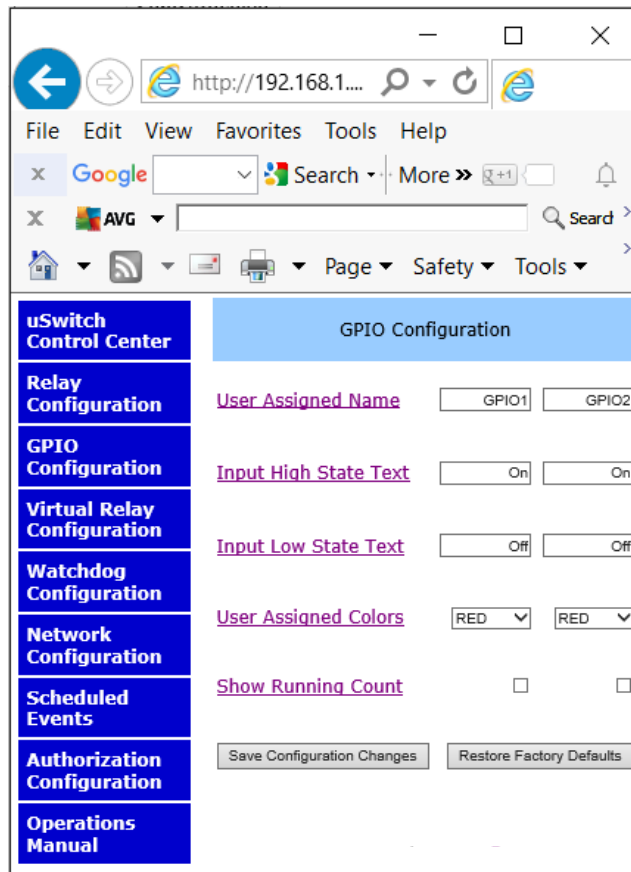

The GPIO Configuration allows a user to customize how each GPIO is displayed, controlled and its control features.

User Assigned Name

These two configurable fields represent user assigned names for each GPIO relay. Once modified all text identifying GPIO1 and GPIO2 from the browser interface will be displayed with customer assigned names.

Input High State Text

This field specifies the text assigned to the GPIO when it is in the high state.

Input Low State Text

This field specifies the text assigned to the GPIO when it is in the low state.

User Assigned Colors

This field indicates the text displayed on the Control Center when the GPIO is in either high state or low state. The choices from the selection box are "ON/OFF", "OPEN/CLOSED", "LOCK/UNLOCK", "START/STOP".

Show Running Count

When checked the internal logging software keeps a running count of full transitions on the associated GPIO and displays it in the "running count" field on the Control Center (home) page. Each time the GPIO goes through a full transition the counter increments. To reset a counter to zero click on the "Clear Counter" button on the Control Center page.

Watchdog Configuration Page

The Auto Reboot Ping feature allows uSwitch to automatically detect failed equipment and reboot or restart it without human intervention. You may set one to three IP addresses or URLs to be periodically tested for each relay. If the uSwitch determines a communication problem exists between any or all of the specified devices, the selected relay will automatically cycle, switching power on and off to reboot a device or devices whose power has been wired across the relay.

The Watchdog feature has been successfully deployed with: IP cameras, kiosks, web signs, cellular routers, Servers, DSL and cable modems, RTUs, control sensors, a variety of Smart Grid technologies, etc.

The following parameters are effective only when uSwitch is set to **Auto Reboot Ping** mode (in the Relay Configuration page).

The screenshot shows a web browser window displaying the uSwitch Watchdog Configuration page. The browser address bar shows the URL <http://192.168.1...>. The page has a navigation menu on the left with the following items: uSwitch Control Center, Relay Configuration, GPIO Configuration, Virtual Relay Configuration, Watchdog Configuration, Network Configuration, Scheduled Events, Authorization Configuration, and Operations Manual. The main content area is titled "Watchdog Configuration" and is divided into several sections:

- URLs to Ping (Relay1)**:
 - Primary:
 - Secondary:
 - Tertiary:
 - Verify All URLs:
- URLs to Ping (Relay2)**:
 - Primary:
 - Secondary:
 - Tertiary:
 - Verify All URLs:
- Watchdog Mode Counters**:
 - Max Ping Failures:
 - Max Reboot Attempts:
- Watchdog Mode Timers**:

	Mins	Secs
Mode Start Delay	<input type="text" value="5"/>	<input type="text" value="0"/>
Time Between Pings	<input type="text" value="1"/>	<input type="text" value="30"/>
Relay Cycle Time	<input type="text" value="0"/>	<input type="text" value="5"/>
- Fault Mode Timer**:

	Hours	Mins	Secs
Period Before Retry on Fault	<input type="text" value="4"/>	<input type="text" value="0"/>	<input type="text" value="0"/>

At the bottom of the page, there are two buttons: "Save Configuration Changes" and "Restore Factory Defaults".

External Heartbeat

This checkbox enables the watchdog to work in network CloakMode™. In this mode the uSwitch watchdog works from an external message embedded in a TCP string sent to the uSwitch from a remotely networked device (its heartbeat). If a uSwitch fails to receive the cloaked message based on the parameters specified than a reboot occurs. If not checked the uSwitch will do all its watchdog testing based on the IP addresses or URLs specified in the URLs to ping field. **Note, for a uSwitch to be placed in watchdog the Ping Auto Reboot checkbox on the Relay Configuration Page must be checked.**

URLs to Ping *(any Relay)*

These three (3) fields contain the IP addresses, or URLs of remote or local devices or servers that uSwitch will ping to test for communication or device problems. These may include the static IP address or remote IP of devices that will be tested (router, computer, Kiosk, network camera, or a device on the opposite side of a communications link). This is ideal for restarting communications devices such as CSU/DSUs/RTUs, cameras, satellite modems, routers, re-closures, power meters etc., after they have locked up.

Verify all URLs

The Verify all URLs checkbox specifies whether response from pings to all URLs (specified in URLs to Ping) is required to determine an operational failure, or if a failure from any single URL is an operational failure.

Max Ping Failures

If no ping responses are received for Max Ping (consecutive) failures than the selected relay will be cycled (forcing a power cycle on any connected device). A ping failure occurs if any single device fails to respond if Verify all URLs is checked, or when no devices respond if Verify all URLs is not checked.

Max Reboot Attempts

After “Max Reboot Attempts” without a successful communication the uSwitch™ exits “Auto Reboot” normal mode and enters “Fault mode”. (During “Fault mode” the uSwitch™ stops cycling the relay to the attached device for the specified Fault Mode Time. The Fault Mode cycle prevents continuous power cycling on a device after detecting that a normal power cycle is not working to bring the device(s) back online.

Mode Start Delay

When uSwitch is first powered on, or after a reboot occurs, the uSwitch will wait “Start Delay” time before restarting a new watchdog testing cycle. This start delay gives a newly restarted device normal setup time to fully establish its connections to external devices before resuming watchdog testing. The recommended minimum and factory default for this field is five (5) minutes. (Certain devices such as cellular modems will not work if not given time to re-establish connections with the ISP and WAN. This can take up to ten minutes).

Time Between Pings

This is the frequency (in seconds) between consecutive device ping attempts to the same URL. This field prevents ping flooding the network and allows the watchdog algorithm to successfully work in situations where the network or its connections are imperfect. (The recommended minimum time between Pings is ninety (90) seconds).

Relay Cycle Time

This is the time period that the uSwitch switches the relay off before switching it back on (giving a device time to have a clean power shutdown and re-power). (The recommended minimum Relay Cycle Time is five (5) seconds)

Period before Retry on Fault

This is the time that uSwitch will remain in “Device Fault Mode” before returning to “Auto Reboot Mode” to re-attempt device startup after the specified Max Reboot Attempt consecutive failures have occurred. This feature prevents the continuous cycling of power on a device that may not have a power cycle curable communication failure. The recommended minimum Period before Retry on Fault is four (4) hours.

Virtual Relay Configuration Page

The Virtual Relay Configuration allows a user to create additional control buttons on the Control Center page of a uSwitchPro to control relays that are on other uSwitch(s) or uSwitchPro(s) across the LAN. This feature is useful to have a single button control multiple different relays simultaneously across a network with the touch of a single button (i.e. for a multi-door lockdown).

Virtual Relay Configuration	
Source of Control	GPIO NONE
User Assigned Name	Remote1 Remote2
Virtual On State Text	On On
Virtual Off State Text	Off Off
User Assigned Colors	RED RED
Momentary(sec)	0 0
Control Slave Relay(s)	1 1
Slave Relay Start IP	192.168.1.200 192.168.1.204
Consecutive Relays	1 1
Slave Relay End IP	192.168.1.200 192.168.1.204
Link Buttons Together	<input type="checkbox"/>
Save Configuration Changes Restore Factory Defaults	

Source of Control

This pull-down field provides four options: None, Button1, Relay1, GPIO. These fields select whether a virtual relay is created on the “Control Center” screen and if so what drives the remote uSwitch’s Relays. If Button1 is selected a virtual button is created on the Relay Control Center and this button controls all remote uSwitches as specified. If Relay1 is selected then the state of Relay1 on this uSwitch drives all other uSwitches specified. If GPIO is specified then the state of the GPIO specified will be used to drive the state of all remote uSwitch Relays.

User Assigned Name

These two configurable fields represent user assigned names for each “virtual relay” button. Once modified all text identifying “Remote1” or “Remote2” from the browser interface will be displayed with the assigned names

Virtual On State Text

This field specifies the text assigned to the virtual relay button to be displayed when it is in the “On” state.

Virtual Off State Text

This field specifies the text assigned to the virtual relay button to be displayed when it is in the “Off” state.

User Assigned Colors

This field specifies which color is assigned to a “virtual” relay for its given state. The choices are “RED/GREEN” or “GREEN/RED”. The colors may indicate different states depending on the physical wiring to the uSwitch.

Momentary (sec)

This timer field puts a “virtual” relay into momentary (pulse) mode. When Momentary is set to zero, the relay is latching. Clicking on the relay’s control changes its state to the opposite state leaving it in that state (latched) indefinitely. A non-zero value in the Momentary field puts the relay in momentary/pulse mode. In this mode, each time the relay is clicked it changes its state only for the number of seconds specified by the Momentary field.

Control Slave Relay(s)

This selection box determines which remote relay or relays on the remote uSwitch(s) or uSwitchPro(s) will be driven. Choices are NONE, 1, 2 or ALL. This is a useful feature if a single HTML button, GPIO or Relay is desired to energize or de-energize multiple relays across a network from a single manual action via a virtual button, or automatically via a sensor attached to an input on one of the GPIOs of a master uSwitch

Slave Relay Start IP

When Control Slave Relay(s) box is set to a selection other than “NONE”, this numeric IP address (such as 192.168.2.17) is the IP address of another uSwitch on this or an outside addressable network whose selected relay or relays are driven by the virtual relay Button, GPIO or Relay specified in the “Source of Control” field on this page. If the IP address specified is not routable from this uSwitch’s network (because of a firewall or addressing limitation) this feature will not drive the relay specified in the Slave Relay Start IP field.

Consecutive Relays

This box allows the entry of the single IP address in the Slave Relay’s Start IP field (above) to extend to multiple consecutive IP addressed uSwitches. This feature enables multiple uSwitch control; however, it requires uSwitches that are driven remotely by a single “virtual” control to have consecutive IP addresses. The number in this box is the number of consecutively addressed uSwitch relays beginning with the address specified by “Slave Relay Start IP” to be controlled by the single “virtual” control being identified (this can be a value of 1 to 4). This only increments the last IP field in field specified by the “Slave Relay Start IP” field above (i.e. 192.168.1.80, 4 would control 192.168.1.80, 192.168.1.81, 192.168.1.82, 192.168.1.83).

Slave Relay’s End IP

This automatically generated informational field shows the last IP address for the last uSwitch to be driven by the “virtual” control button. It is calculated by adding the “Consecutive Relays” count to the “Slave Relay Start IP” address.

Link Buttons Together

This checkbox is only active when both Virtual Relays are configured as “Buttons” in the “Source of Control” pull down. When checked it results in eliminating the second virtual button on the uSwitch Control Center page and ties all remotely driven relays from both fields to a single virtual button. (Linking Buttons Together enables a single push button to control up to Eight (8) remote uSwitches and a single or all of their relays from a single “Virtual Control”).

Scheduled Event Page

The screenshot shows a web browser window displaying the uSwitch Control Center interface. The browser's address bar shows the URL `http://192.168.1...`. The interface has a blue sidebar on the left with the following menu items: uSwitch Control Center, Relay Configuration, GPIO Configuration, Virtual Relay Configuration, Watchdog Configuration, Network Configuration, Scheduled Events (highlighted), Authorization Configuration, and Operations Manual. The main content area is titled "Current Time" and "Relay Control Schedule". Under "Relay Control Schedule", there are fields for "Network Time Servers" with "Primary: 'time-c.nist.gov'" and "Secondary: 'time-a.nist.gov'". Below this is a section for "Relay1" which contains a table with columns: Day of WEEK, Enabled, Start [Hour : Min], Start Event, End [Hour : Min], and Event. The table rows are for Sun, Mon, Tue, Wed, Thu, Fri, and Sat. The "Enabled" column has checkboxes, and the "Event" column has "On" or "Off" dropdown menus. At the bottom of the table are two buttons: "Save Configuration Changes" and "Restore Factory Defaults".

Day of WEEK	Enabled	Start [Hour : Min]	Start Event	End [Hour : Min]	Event
Sun	<input type="checkbox"/>	10 : 00	Off	17 : 00	On
Mon	<input checked="" type="checkbox"/>	08 : 30	Off	17 : 00	On
Tue	<input checked="" type="checkbox"/>	08 : 30	Off	17 : 00	On
Wed	<input checked="" type="checkbox"/>	08 : 30	Off	17 : 00	On
Thu	<input checked="" type="checkbox"/>	08 : 30	Off	17 : 00	On
Fri	<input checked="" type="checkbox"/>	08 : 30	Off	17 : 00	On
Sat	<input type="checkbox"/>	10 : 00	Off	17 : 00	On

Scheduled Event Page

This page is only effective if the "Use Schedule" box is checked in the relay Configuration page for a given relay. If it is then either one or both relays will follow the schedule from the Schedule event page. If a day of week is checked then the relay will reflect the state specified in the event after the time on the day schedule is reached. Time is in 24 hour format. Events can be set to either "on" or "off". To use the schedule NTP servers must be available to the uSwitch. The NTP servers are specified on the Network Configuration page as is the Time Zone and the Daylight Savings property.

Authorization Configuration Page

The Authorization Configuration Page is used to change uSwitch access passwords. A password is required on initial login to uSwitch. Passwords may be up to fifteen (15) characters and numbers. We recommend difficult passwords of at least eight (8) characters including both letters and numerals.

User Password Changes	
Usernames and Passwords (Max 15 characters)	
Username	<input type="text"/>
User Password	<input type="text"/>
Re-enter User Password	<input type="text"/>

Administrator Password Changes	
Administrator Passwords (Max 15 characters)	
Administrator Password	<input type="text"/>
Re-enter Administrator Password	<input type="text"/>

To change user passwords or administrator passwords all fields on this page must be entered completely. Once access is provided to the Authorization Configuration screen the privileged user can change the uSwitch's "Username" field, and the "User Password" which provides access for the Control Center. The user must also, either re-enter the existing Administrator password, or provide a new Administrator password (the administrator password provides access to all uSwitch configuration options and should be given out discriminately).

Security Notes

uSwitch is an extremely secure networking control device.

Passwords: uHave Control recommends that all passwords are secure and non-obvious. This means we recommend at least 8 characters, including digits and upper and lower case letters. using both upper and lower case.

VPN(s) and Firewall(s): If a firewall is in place the firewall can be set up to limit access to only certain network addresses. Additionally a VPN may be used between the uSwitch and connected devices limiting access to only those devices or individuals who have access via the VPN.

uSwitch/uSwitchPro Board Schematic

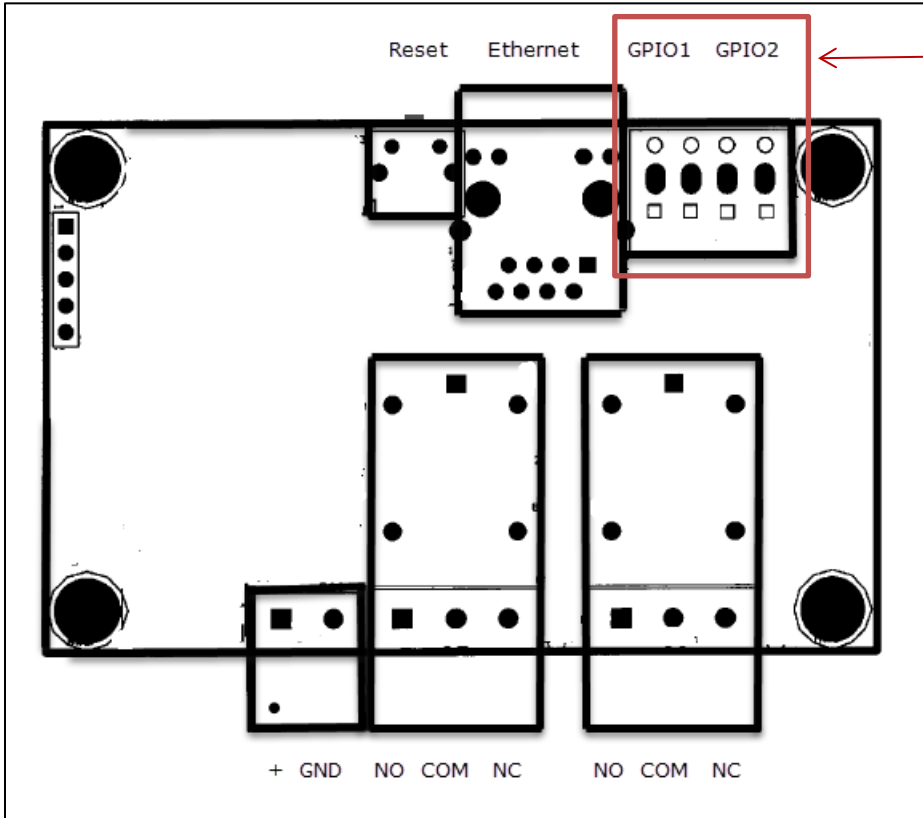

The GPIO contacts are only on the uSwitchPro

Configurations

Access Control to Electronic Door Strike

The following is a configuration where uSwitch is used to provide access control. When connecting to door strikes a reverse-bias diode is recommended. In this example, a reverse-bias diode is connected in parallel with the lock to protect the relay contacts from the inductive kickback that can occur when the lock is switched. A variety of diodes is available and can be ordered either online or directly from us. (For AC door access control no diode is necessary, for DC powered devices a 60V p/p diode is recommended).

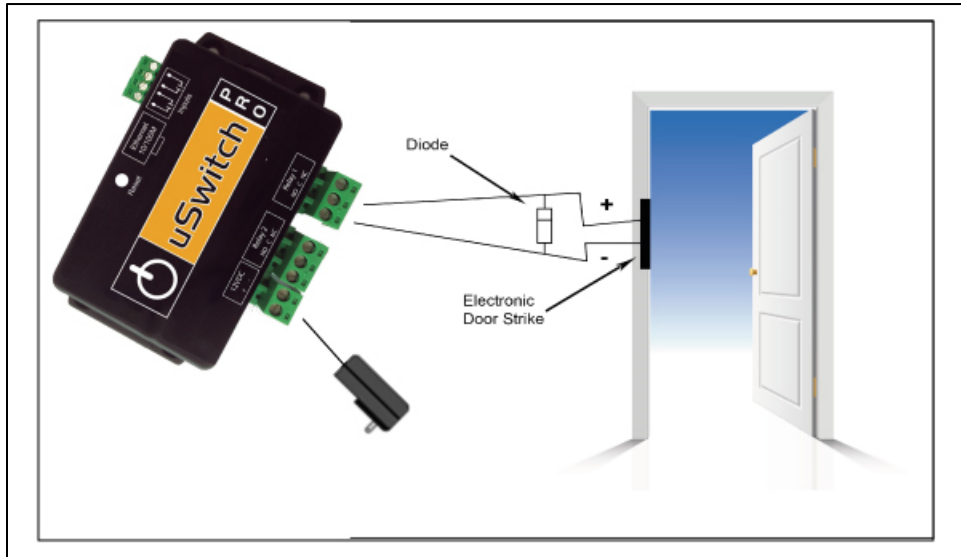

Driving multiple uSwitch Relays from a single uSwitch GPIO or Virtual Button

In addition to a physical push button driving the local relay on the same uSwitch either that push button or the button generated on the Control Center page, or a virtual button can be created to command a relay on a remote uSwitch. Once setup, pushing that button will drive all relays in its configuration as specified by the virtual or physical button. Each uSwitch can be programmed to drive up to eight separate relays on the network. Additionally, if a relay output is hardwired into its own, or another uSwitch's GPIO it can in turn be used to drive an additional 8 relays. By daisy chaining uSwitches in this manner a single GPIO can drive an unlimited number of relays on other uSwitches.

Connecting to High Power devices (such as Motors, etc)

For loads greater than those rated for the uSwitch's internal relays, or when connected to devices with high inrush or peak current surge an external relay should be used with the uSwitch triggering the relay. The illustration below shows how a high current motor or other high load device can be controlled using by wiring to an external relay. A variety of external relays is available and can be ordered either online or directly from uHave Control.

When relays switch inductive loads such as motors, transformers, relays, etc., electricity will arc across the internal relay contacts each time the contacts open. Over time this causes wear on the relay contacts which can shorten their life span. When switching a high inductive load, it is recommended that simple relay contact protection devices be used. To be economically feasible uSwitch cannot provide relay protection for all possible loads.

For applications with excessive loads, the following diagram shows a relay contact protection circuit for DC and for AC applications. For component values required to provide sufficient contact protection for a specific application, consult the application reference. Note: for DC circuits a diode is used and for AC circuits an RC circuit across the load can be used.

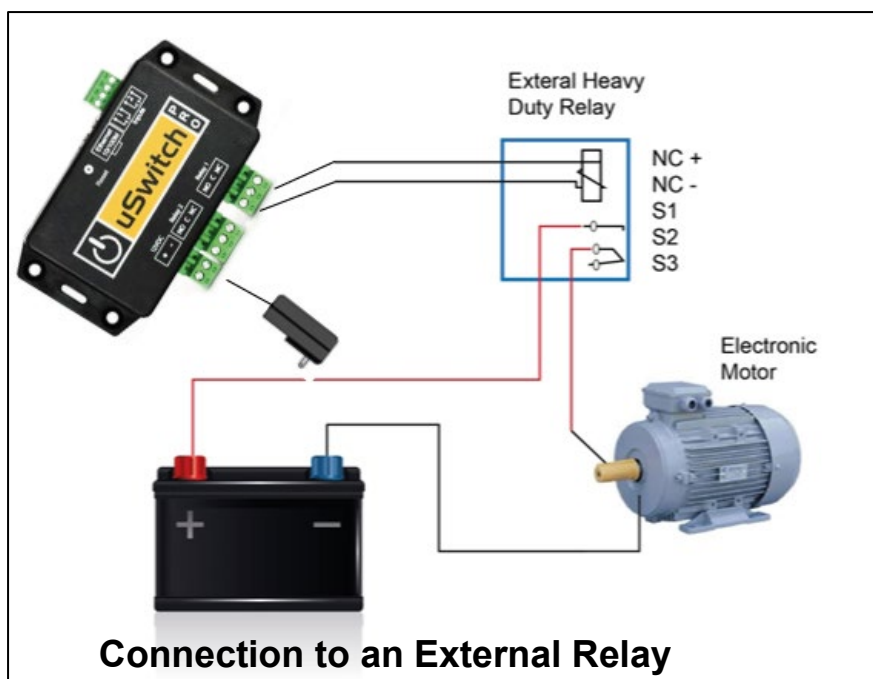

Hard Wired Network Connection

Using standard Ethernet cabling, connect uSwitch's Ethernet port to a 10 Base T or 10/100 Base T Ethernet connection such as a network switch, router or cellular mode. To connect directly to a computer, use a "crossover/Null Modem" cable. For connection to a router or switch, a standard "straight-through" cable is recommended.

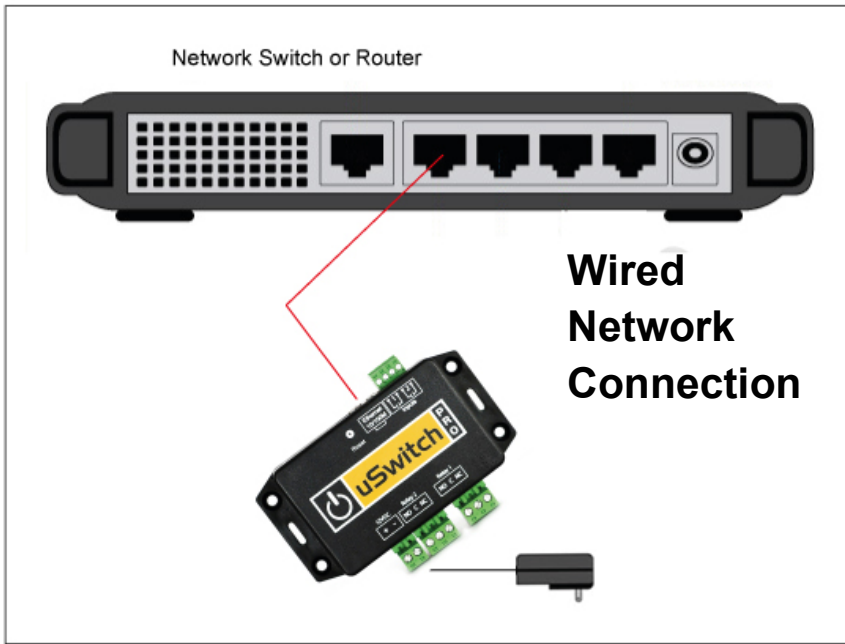

Wireless Network Connection

To operate uSwitch in a wireless network environment, connect the uSwitch's Ethernet port to a wireless repeater or bridge. The wireless bridge in turn connects to the wireless network. The wireless Ethernet Bridge or router must be properly set up for the wireless network first. This information is contained in the End User documentation for the wireless networking device. A variety of wireless repeaters is available and can be ordered either online or from uHave Control.

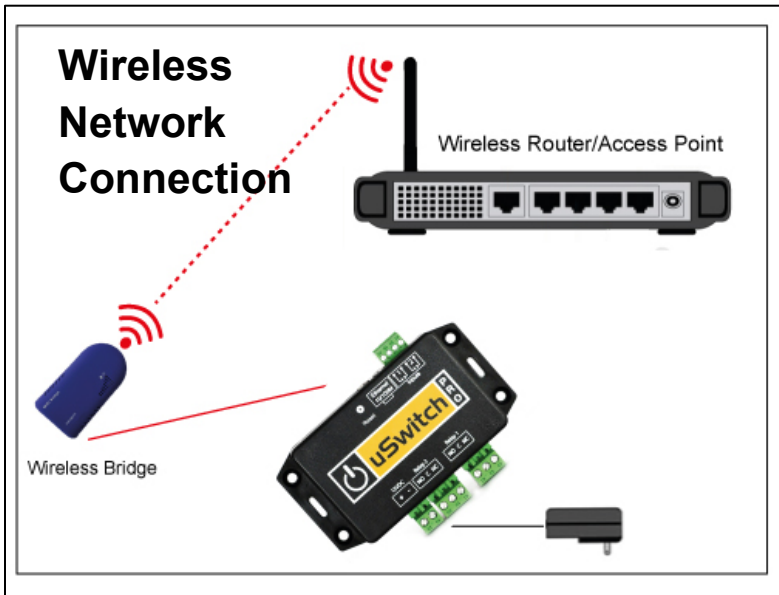

The A-Plug Universal 110VAC uSwitch Adapter

The A-Plug is designed to easily snap into uSwitch or uSwitchPro converting its two relay outputs into two 110VAC outlets. There is no need for wiring or splicing with A-Plug. The A-Plug powers the uSwitch and receives its power directly from any wall outlet to which it is plugged in.



Troubleshooting:

Before returning a device test the power input transformer to uSwitch. This can easily be done by swapping out with a known working power transformer.

Appendix A: Factory Default Settings

In the event that the IP address or passwords are forgotten and you cannot log in to uSwitch, you can reset uSwitch to its factory default settings. With power on press the reset button for a minimum of ten (10) seconds. After ten (10) seconds, release the reset button. Wait thirty (30) seconds then fully cycle power on uSwitch. At this point all settings should be restored to factory default settings (shown below)

Network Configuration:

Host Name: U-SWITCH
Enable DHCP: unchecked
IP Address: 192.168.1.199
Gateway: 192.168.1.1
Subnet Mask: 255.255.255.0
HTTP Port: 80
TCP Port: 9760
Primary DNS: 8.8.8.8
Secondary DNS: 8.8.4.4
Auto Discovery: checked
MAC Address: Predefined at Factory (non-configurable)

Relay Configuration:

User Assigned Name: Relay1/Relay2
User Assigned Text: On (Off)
User Assigned Colors: Red/Green
Power Up State: Last (sets relay to return to previous state after each uSwitch power cycle)
Momentary(sec): 0 (non-momentary)
Ping Auto Reboot: unchecked
Allows Master Control: unchecked
Sync to Local GPIO: unchecked
Sync Inverts GPIO: unchecked
Timed Reboot (hours): Off
Link Buttons Together: unchecked

GPIO Configuration:

User Assigned Name: GPIO1/GPIO/2
GPIO Hi State Text: On/On
GPIO Low State Text: Off/Off
User Assigned Colors: Red/Green
Show Running Count: unchecked
Peak Detect: 250
Peak Cycle Time: 1 min

Watchdog Configuration:

URLs to Ping

External Heartbeat: unchecked
URL Primary: 8.8.8.8
URL Secondary: 4.2.2.2
URL Tertiary: 192.168.0.1
Verify All URLs: checked

Auto Reboot Counters

Max Ping Failures: 3
Max Reboot Attempts: 3

Auto Reboot Timers

Mode Start Delay: 5 min, 0 seconds
Time Between Pings: 1 min, 30 seconds
Relay Cycle Time: 5 Seconds

Fault Mode Timer

Period Before Retry on Fault: 4 hours, 0 minutes, 0 seconds

Authorization Configuration

Username: "admin"

User Password: "admin"
Admin Password: "admin"

Appendix B: Specifications

AC

Relay Capacity: 7.5 A Max at 105-125 VAC, 5 A Max at 210-240 VAC

Power Requirements:

Model uSwitch

Voltage: 12VDC – 24VDC%

Model uSwitch, uSwitchPro

Standby Current

(Relays OFF) - 58mA

One Relay on - 92mA

Both Relays on - 126mA

Relay Ratings:

Rated Carrying Current: 5A @ 125VAC, 5A @ 250VAC, 10A @ 24VDC

Max Current: 10A

Max Voltage: 240VAC, 110 VDC

Relay Performance

Relay Control Options: ON/OFF, Pulsed, Automatic, Momentary

Contact Resistance <50m ohms (initial value)

Contact Material: Ag alloy

Max Switching Voltage: 240VAC, 110VDC

Max Switching Current 20A

Mechanical life (rated load) 10,000,000 ops.

Electrical life (rated load) 100,000 ops.

Networking:

Network: 10/100 Base-T, IPv4

Network Setup: static IP address assignment, DHCP, HTTP port selectable

Network Connector: 8-pin RJ-45 socket

Connectors:

Power/Input: 2-position, removable terminal strip, 3.81mm terminal spacing

Relays: 3-position (Normally Closed, Normally Open, Common) removable terminal, 3.81mm terminal spacing

Ethernet: 8-pin RJ-45 socket

GPIOs 4-position, removable terminal strip, 3.0mm terminal spacing

LED Indicators: (on Ethernet jack)

-Network linked

-Network activity

Physical:

MTBF 360,000 hours

Temperature 0 – 50 degrees C (-30C, +80C)

Size: .42 in (106 mm) long, 2.15 in (55mm) wide, 1.0 in (25 mm) deep

Weight: 4.3 oz. (122 grams)

Password Settings:

Password protection on setup page: Yes

Password protection on configuration pages: Yes

Other:

Virtual Control: Yes

Control Linking: Yes

Appendix C: Updating Firmware

The uSwitchPro Supports Firmware upgrades. To upgrade firmware follow these steps.

1. Download the Ethernet bootloader Programmer Zip file from uHaveControl.com, “ethernetloader.zip”.
2. Download the latest firmware from the uHave Control Website (file.hex).
3. Unzip the files onto your windows machine
4. Go to the directory where the files were unzipped and click on “enc_loader.exe”
5. The following screen is loaded

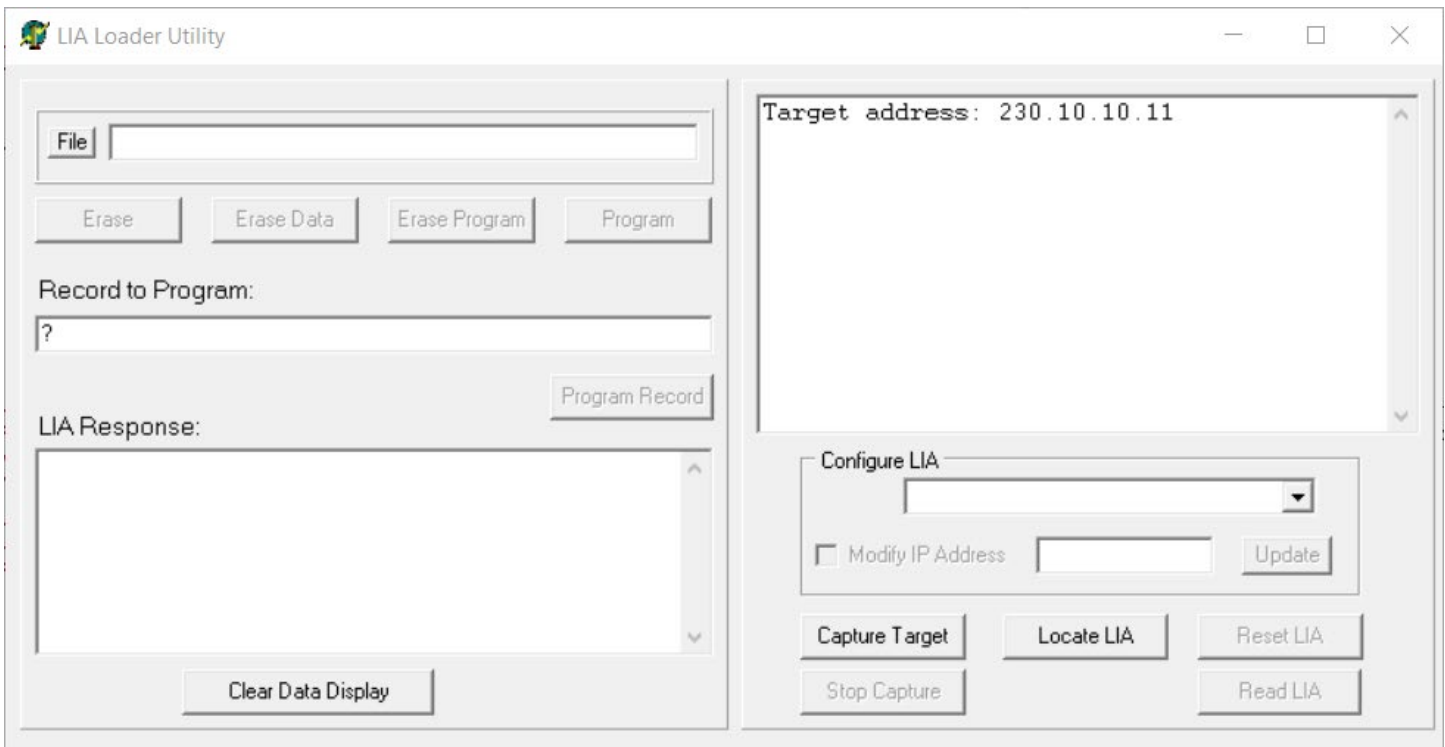

6. On the file menu select the latest firmware from the directory where you placed it above in step 3.

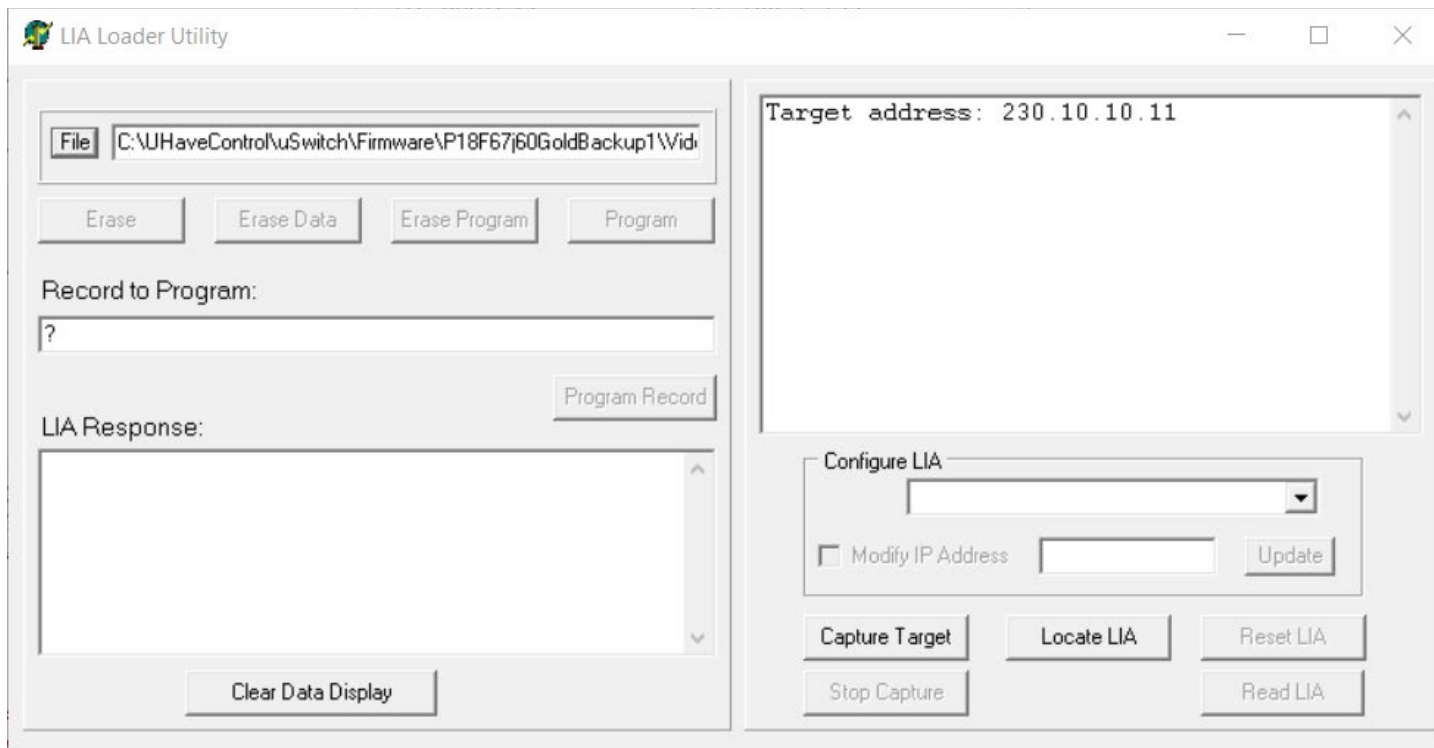

7. Cycle Power on the uSwitch to be upgraded
8. Click Locate LIA, the following screen shows up with the uSwitch identified

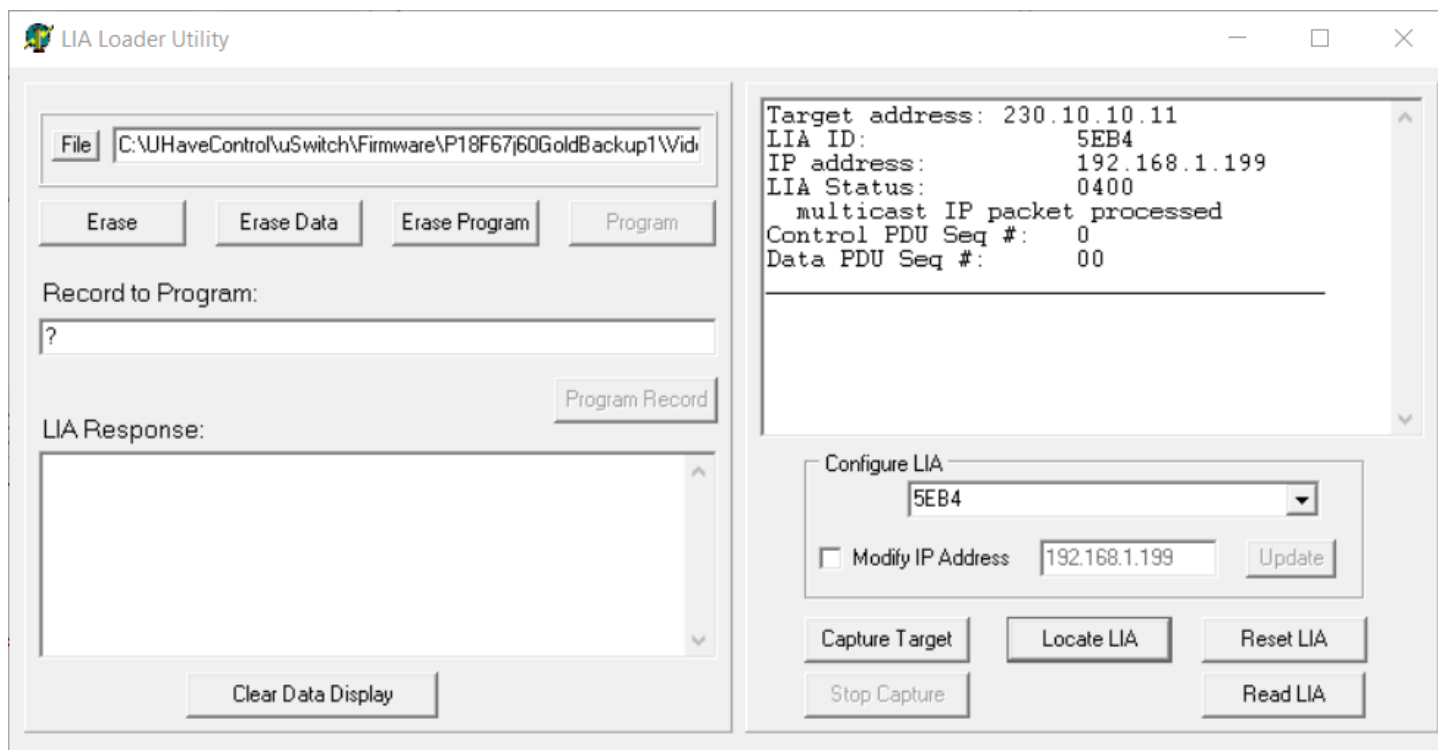

9. Immediately click on Reset LIA
10. Immediately click “Capture Target” and then immediately click “Program” under the file you selected in Step 6 (steps 8-10 must be done within 5 seconds of each other).
11. The software will begin to download the new firmware to the uSwitch.
12. On completion you will see a screen similar to the one below. (notice the downloaded file name is specified and the message “programming complete” should be in the message window on the upper right).

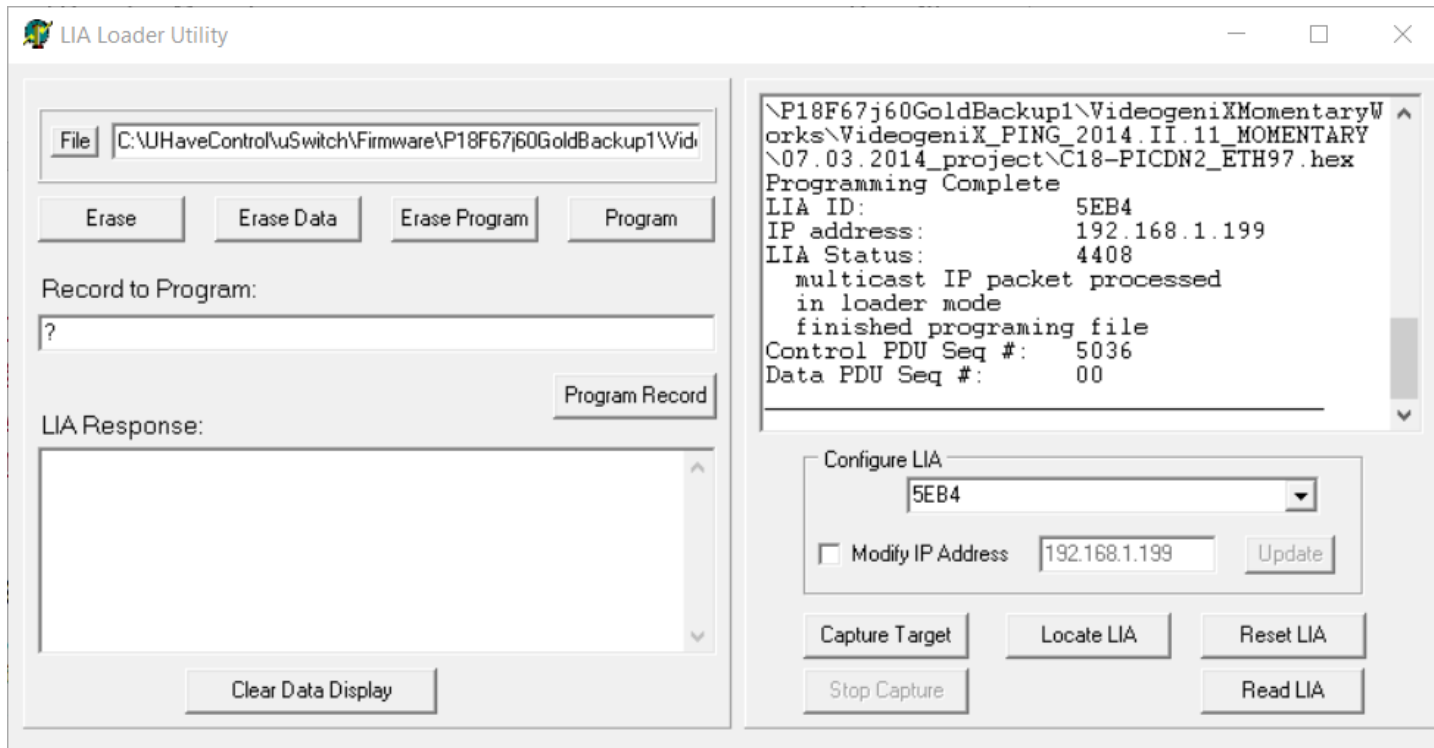

13. Click Reset LIA one final time. Wait 5 seconds and then you can log into the uSwitch with the upgraded firmware.
14. If this update requires a webserver update than also upload the .bin file associated with the firmware upgraded..
15. To upload web-server pages enter the ip address of the uSwitch followed by the “/upload” string. (192.168.1.199/upload). Click OK to upload.

Appendix B: Installing New Firmware

From time to time, updates are made to WebRelay™ firmware. The firmware can be updated in the field. The procedure for updating the firmware is outlined below. Please note that it is important that this procedure is followed precisely.



Requirements

The firmware update software requires Windows XP/Vista/7 with the .Net framework installed. The .Net framework is generally installed automatically through Windows update. To install it manually, go to the following address:

<http://www.microsoft.com/downloads/details.aspx?FamilyId=333325FD-AE52-4E35-B531-508D977D32A6&displaylang=en>

Select the Download button. Once you've downloaded the installation file, double click on the installation file to install the framework.

Setup

1. Download the firmware zip file from the ControlByWeb website. Only a WebRelay™ image can be installed on WebRelay™ so make sure the correct image is being downloaded.
2. bootloader.exe will connect to WebRelay™ using default IP address 192.168.1.2, not the address currently assigned to WebRelay™. After the update, all settings will be lost and the device will return to its default IP address of 192.168.1.2. Configure the PC to the same subnet as the IP address 192.168.1.2, such as 192.168.1.10. For instructions on doing this, see section 2.3 Establishing Communications for Setup.

Note: The IP address of WebRelay™ will automatically be set to the default 192.168.1.2 during the update process.

Note: A crossover cable cannot be used during the update procedure; an ethernet switch will be necessary to properly update the firmware.

3. Open the bootloader.exe utility on the computer by double clicking on the downloaded file (Figure

4. Within the ControlByWeb™ Programmer utility programmer, select File, then Open. Specify the firmware image downloaded from the ControlByWeb™ web site.

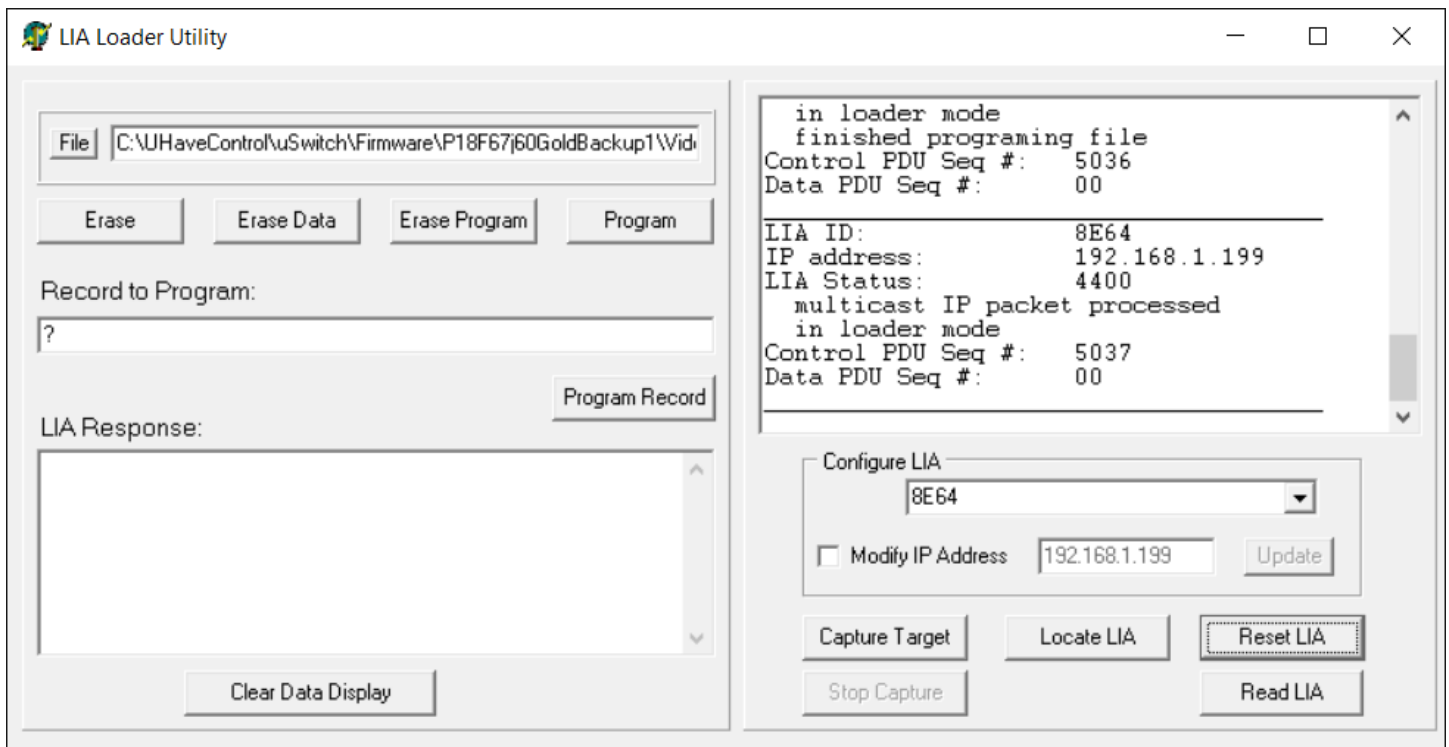
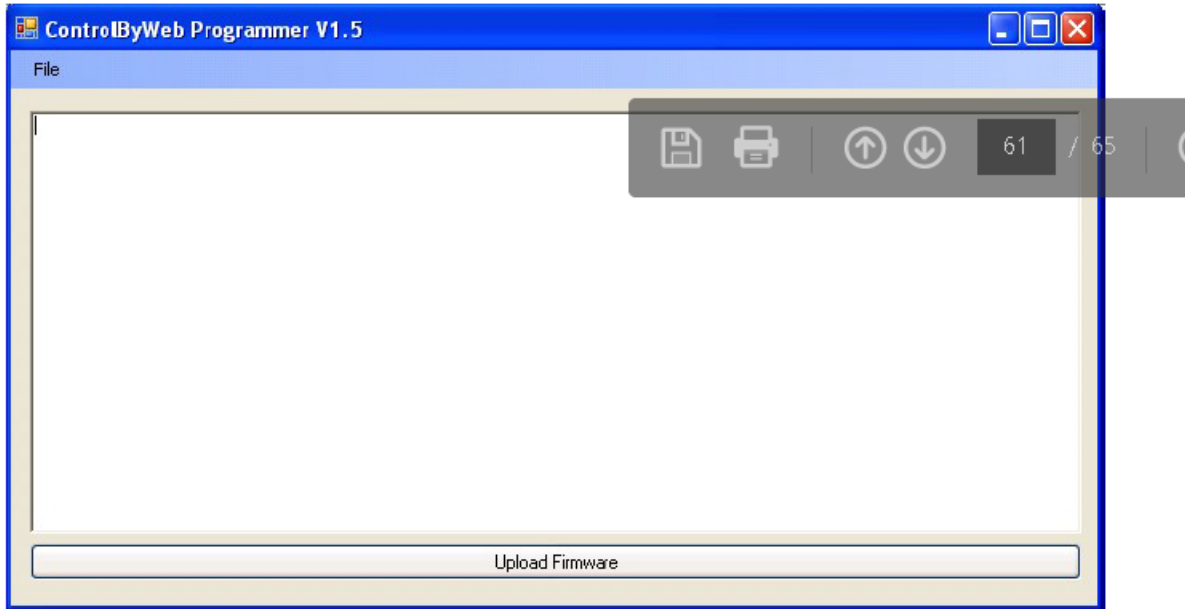

Device Dimensions:

uSwitch, uSwitchPro, aPlug Dimensions

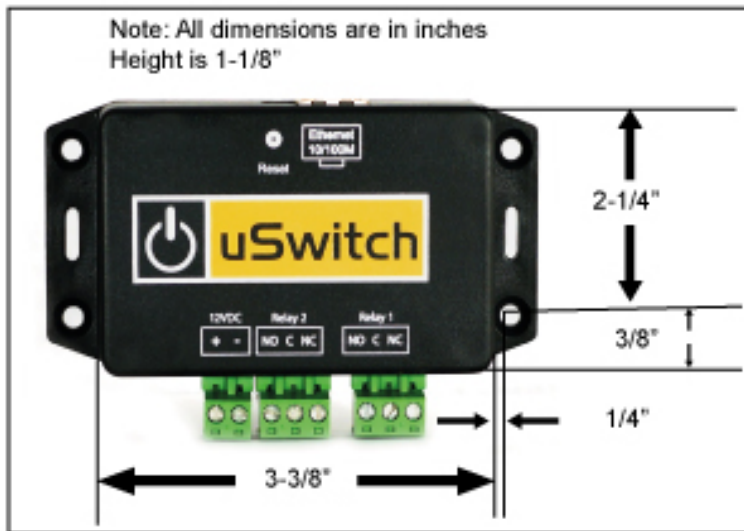

Uswitch PoE Dimensions:

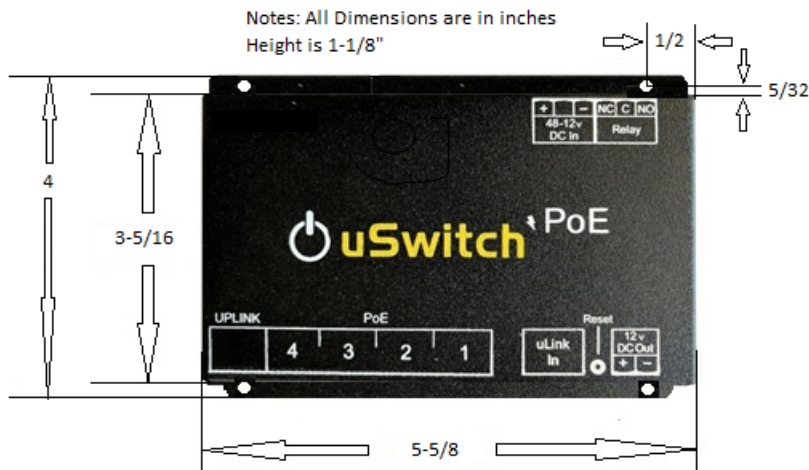

Product Safety: FCC Statement

This device complies with Part 15 of the FCC Rules. Operation is subject to the following two Conditions:

- This device may not cause harmful interference.
- This device must accept any interference received, including interference that may cause undesired operation.

Warning:

This equipment has been tested and found to comply with the limits for a Class B digital device, pursuant to Part 15 of the FCC Rules. These limits are designed to provide reasonable protection. This equipment generates uses and can radiate radio frequency energy and, if not installed and used in accordance with the instructions, may cause interference to radio communications. However, there is no guarantee that interference will not occur in a particular installation. If this equipment does cause harmful interference to radio or television reception, which can be determined by turning the equipment off and on, the user is encouraged to try to correct the interference by one or more of the following measures:

- Reorient or relocate the receiving antenna
- Increase separation between the equipment and receiver.
- Connect the equipment into an outlet on a circuit different from that to which the receiver is connected.

Consult the dealer or an experienced radio/TV technician for help.

Warranty

uHave Control warrants this product, if used in accordance with all manufacturers' specification, to be free from original defects in material and workmanship for a period of One Year from the date of initial purchase. If the product should prove defective within that period, Seller will repair or replace the product at its sole discretion.

This warranty is extended to the original purchaser of the equipment only. Call uHave Control Technical service to receive a Return Materials Authorization (RMA) Number prior to sending any equipment back for repair. Include all cables, power supplies and proof of purchase with shipment. For warranty service or repair, return to uHave Control at 241 Perkins Street, A501, Jamaica Plain, MA 02130. Purchaser shall prepay all charges for shipping to uHave Control. uHave Control will pay the shipping charges to return the product to the purchaser as long as the product is shipped within the United States. If the product is shipped outside of the United States, the purchaser shall pay all shipping charges, duties, and taxes.

THIS WARRANTY DOES NOT APPLY TO NORMAL WEAR OR TO DAMAGE RESULTING FROM ACCIDENT, IMPROPER USE, MISUSE, UNAUTHORIZED REPAIR, TAMPERING, MODIFICATION, IMPROPER CONNECTION, OPERATION OUTSIDE THE ENVIRONMENTAL OR ELECTRICAL SPECIFICATIONS, ABUSE OR NEGLIGENCE. SELLER MAKES NO EXPRESS WARRANTIES OTHER THAN THE WARRANTY EXPRESSLY SET FORTH HEREIN. EXCEPT TO THE EXTENT PROHIBITED BY LAW, ALL IMPLIED WARRANTIES, INCLUDING ALL WARRANTIES OF MERCHANT ABILITY OR FITNESS FOR ANY PURPOSE ARE LIMITED TO THE WARRANTY PERIOD SET FORTH ABOVE; AND THIS WARRANTY EXPRESSLY EXCLUDES ALL INCIDENTAL AND CONSEQUENTIAL DAMAGES.

Limitation

Further, the warranty does not cover Acts of God, such as fire, flood, hurricanes, and tornadoes. This warranty does not cover damage to property, equipment, direct, indirect, consequential, or incidental damage (including damage for loss of business profit, business interruption, loss of data, and the like) arising out of the use or misuse of this product. UNDER NO CIRCUMSTANCES WILL THE LIABILITY OF uHave Control TO THE PURCHASER OR ANY OTHER PARTY EXCEED THE ORIGINAL PURCHASE PRICE OF THE PRODUCT, REGARDLESS OF THE FORM OF THE CLAIM. No other warranty is expressed or implied. uHave Control specifically disclaims the implied warranties or merchantability and fitness for particular purpose. Some jurisdictions may not allow the exclusion of limitation of liability for consequential or incidental damage.

Notice:

Changes or modification not expressly approved by the party responsible for compliance could void the user's authority to operate the equipment.

Trademark and Copyright Information

This document is Copyrighted ©2022 by uHave Control, Inc. All rights reserved. uHave Control and uSwitch and uSwitchPro are Trademarks of uHave Control. All parts and features of our products and designs including but not limited to media, graphics, manuals, PCB layouts, web design, algorithms, software, firmware, Schematics, etc., are property of uHave Control, Inc. ©2022. uHave Control products may not be opened, disassembled, copied, or reverse engineered without explicit written agreements to do so.

This manual may not be reproduced, copied, faxed or transmitted in any form or by any means, electronic or mechanical., other than by the end-user, or purchaser. uHave Control Inc., assumes no responsibility for any mistakes or errors herein.

uHave Control, Inc. reserves the right to modify its products, features, interfaces, specifications, business practices at any time.

uHave Control, Inc. is not liable for any damages or losses including direct, indirect, special, incidental, or consequential damages or losses arising from either the use of any information contained within this manual or the use of any products or services referenced in this manual.

uHave Control

**241 Perkins Street, A501
Jamaica Plain, MA 02130**

Copyright © 2022 uHave Control, Inc.

617-271-4445

www.uhavecontrol.com