



Aeotec

## Single Nano Switch

SKU: AEOEZW139



### Quickstart

This is a **Switch for Europe**. To run this device please connect it to your mains power supply. To add this device to your network execute the following action:

1. Set your Z-Wave controller into pairing mode.
2. Press the Action Button on the Nano Switch or toggle the external manual switch once, the green LED (non-secure indication) will blink to indicate the Nano Switch is entering into pairing mode.

### What is Z-Wave?

Z-Wave is the international wireless protocol for communication in the Smart Home. This device is suited for use in the region mentioned in the Quickstart section.

Z-Wave ensures a reliable communication by reconfirming every message (**two-way communication**) and every mains powered node can act as a repeater for other nodes (**meshed network**) in case the receiver is not in direct wireless range of the transmitter.

This device and every other certified Z-Wave device can be **used together with any other certified Z-Wave device regardless of brand and origin** as long as both are suited for the same frequency range.

If a device supports **secure communication** it will communicate with other devices secure as long as this device provides the same or a higher level of security. Otherwise it will automatically turn into a lower level of security to maintain backward compatibility.

For more information about Z-Wave technology, devices, white papers etc. please refer to [www.z-wave.info](http://www.z-wave.info).



### Product Description

Aeotec Nano Switch is a low-cost Z-Wave Switch specifically used to enable Z-Wave command and control (on/off) of any wall switches. In the event of power failure, non-volatile memory retains all programmed information relating to the unit's operating status.

It can connect to 2 external manual switches to control the load ON/OFF independently. Its surface has a pin socket, which can be used for connecting to the touch panel, so you can also use the touch panel to control the Nano Switch.

The Dual Nano Switch is also a security Z-Wave device and supports Over The Air (OTA) feature for the products firmware upgrade.

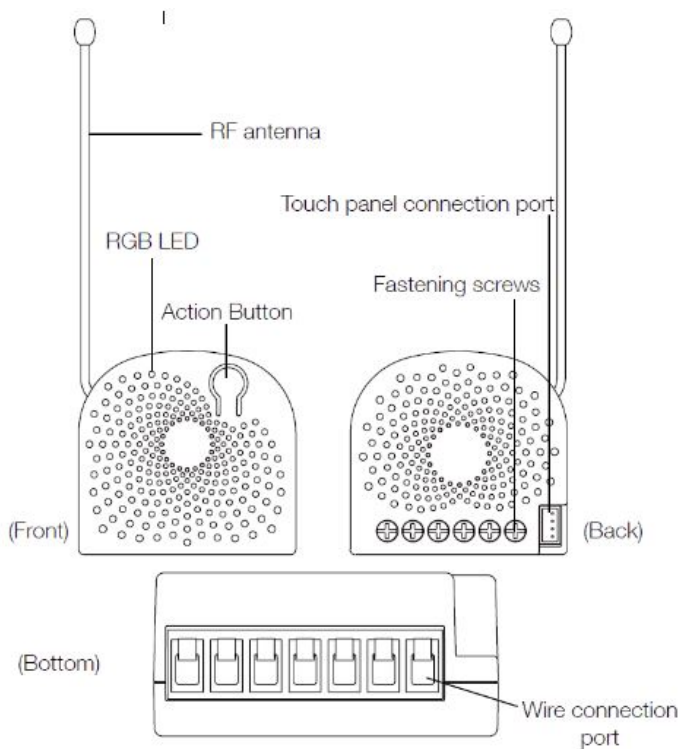

## Prepare for Installation / Reset

Please read the user manual before installing the product.

In order to include (add) a Z-Wave device to a network it **must be in factory default state**. Please make sure to reset the device into factory default. You can do this by performing an Exclusion operation as described below in the manual. Every Z-Wave controller is able to perform this operation however it is recommended to use the primary controller of the previous network to make sure the very device is excluded properly from this network.

### Reset to factory default

This device also allows to be reset without any involvement of a Z-Wave controller. This procedure should only be used when the primary controller is inoperable.

Set Parameter 255

### Safety Warning for Mains Powered Devices

**ATTENTION:** only authorized technicians under consideration of the country-specific installation guidelines/norms may do works with mains power. Prior to the assembly of the product, the voltage network has to be switched off and ensured against re-switching.

## Installation

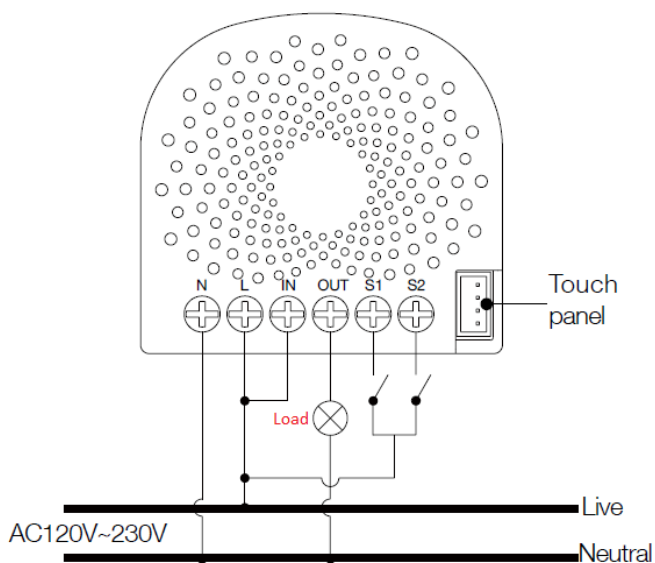

### Notes for the wire connection ports:

N – Power input for neutral

L – Power input for live

IN – Input for load power supply

## S2 – External switch control for load 2

1. Shut off the main circuit breaker of your home for safety during the installation and ensure the wires are not short circuited during the installation which will cause damage to the Nano Switch.

**Note:** Your home's main circuit breaker must support the overload protection for safety.

2. Preparing connection wires 14 AWG power wires for Input/ Output. 18 AWG copper wires for external manual switch. Use the wire stripper cut the metallic part of the connection wire and make sure the length of the metallic part is about 5mm.

**Note:** All connection wires needs to be flexible cable.

### Wiring diagram of AC120V/230V power input.

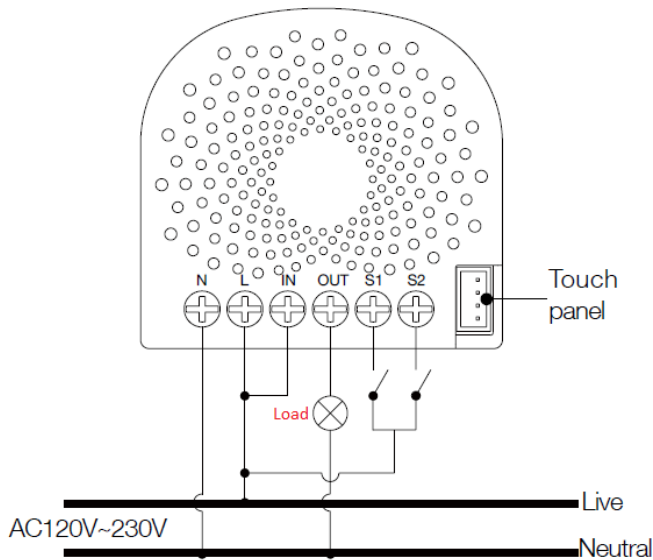

In some cases, you may have some loads just only can be used on the voltage of DC24V and hope that it still can be controlled by the Nano Switch, so please refer to the following diagram to achieve this:

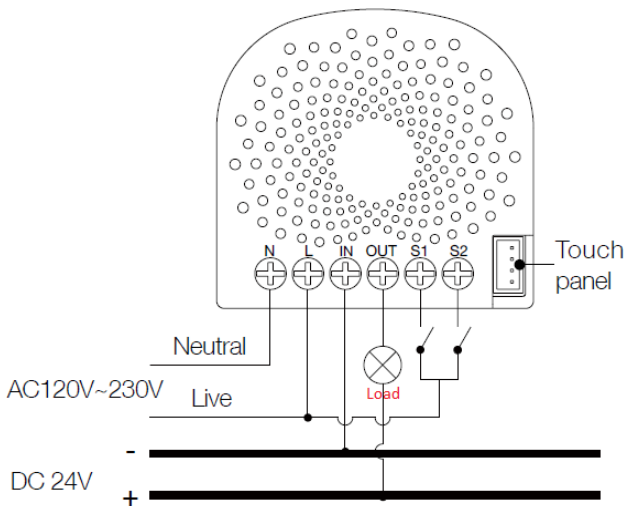

**Note:** The "IN" terminal should be connected to the "-" of DC 24V input.

### Wiring diagram of DC24V power input.

Since the Nano Switch also supports the DC24V power input, so you can use it to control the loads that powered by DC24V.

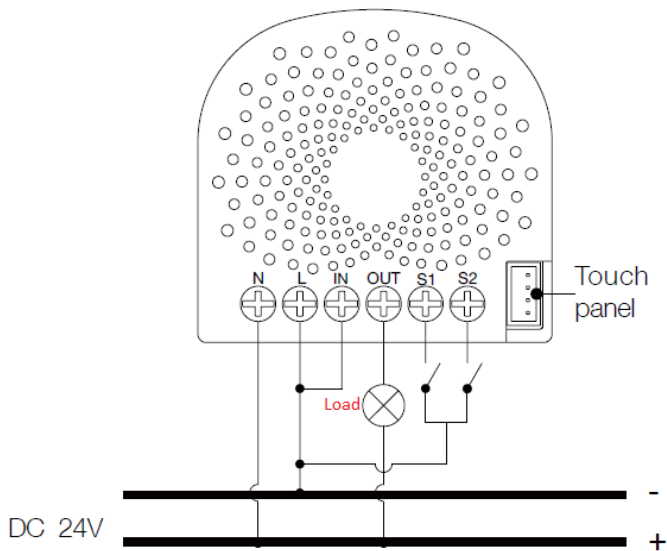

If the output loads should be only powered by AC120V or AC230V, you can change the wire connection as below:

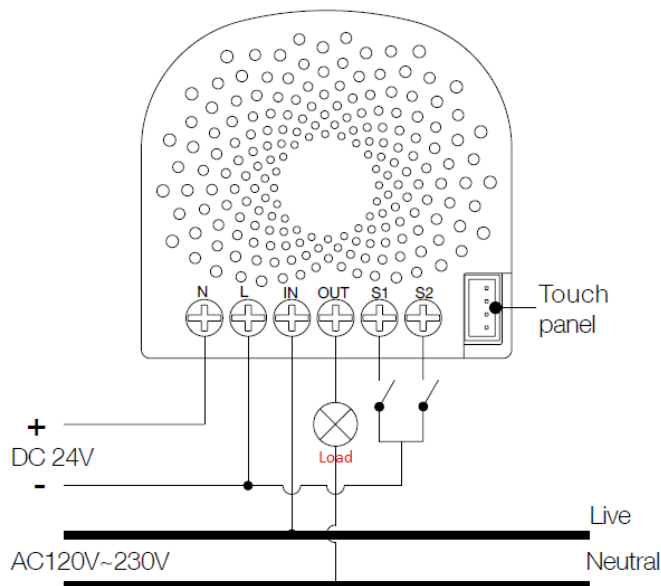

**Note:** The "IN" terminal should be connected to the "Live" of AC 120V/230V power wire.

All above wiring diagrams show that the Nano Switch uses 2-Way or momentary button switches as the external manual switch for 2-Way connection. The below diagram will show you that the Nano Switch uses the SPDT (Single-Pole Double-Throw) switches as the external manual switch for 3-Way connection.

**Wiring diagram of 3-Way connection for the external manual switch.**

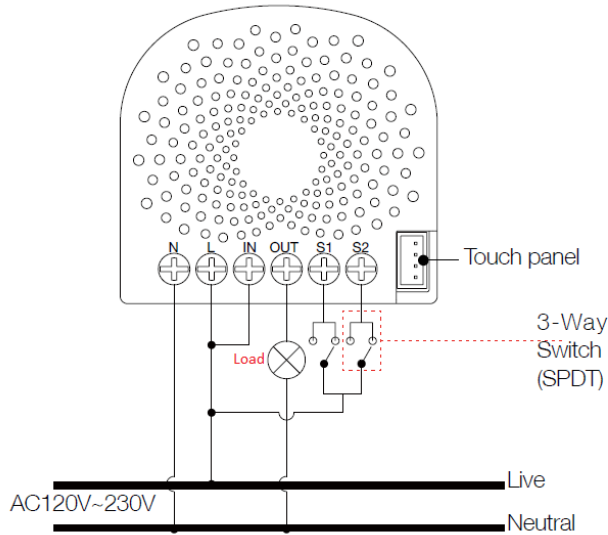

### Inclusion/Exclusion

On factory default the device does not belong to any Z-Wave network. The device needs to be **added to an existing wireless network** to communicate with the devices of this network. This process is called **Inclusion**.

Devices can also be removed from a network. This process is called **Exclusion**. Both processes are initiated by the primary controller of the Z-Wave network. This controller is turned into exclusion respective inclusion mode. Inclusion and Exclusion is then performed doing a special manual action right on the device.

#### Inclusion

1. Set your Z-Wave controller into pairing mode.
2. Press the Action Button on the Nano Switch or toggle the external manual switch once, the green LED (non-secure indication) will blink to indicate the Nano Switch is entering into pairing mode.

#### Exclusion

1. Set your Z-Wave controller into removal mode.
2. Press the Action Button on the Nano Switch or toggle the external manual switch 3 times in fast succession.

### Quick trouble shooting

Here are a few hints for network installation if things dont work as expected.

1. Make sure a device is in factory reset state before including. In doubt exclude before include.
2. If inclusion still fails, check if both devices use the same frequency.
3. Remove all dead devices from associations. Otherwise you will see severe delays.
4. Never use sleeping battery devices without a central controller.
5. Dont poll FLIRS devices.
6. Make sure to have enough mains powered device to benefit from the meshing

### Association - one device controls an other device

Z-Wave devices control other Z-Wave devices. The relationship between one device controlling another device is called association. In order to control a different device, the controlling device needs to maintain a list of devices that will receive controlling commands. These lists are called association groups and they are always related to certain events (e.g. button pressed, sensor triggers, ...). In case the event happens all devices stored in the respective association group will receive the same wireless command wireless command, typically a 'Basic Set' Command.

#### Association Groups:

Group Number	Maximum Nodes	Description
1	5	Z-Wave Plus Lifeline. When the load state of Nano Switch (on/off) is changed, the Hail CC, Switch Multilevel Report and Basic Report (configured by parameter 80) can be sent to the associated nodes in this group.
2	5	Forward the Basic Set, Switch All, Scene Activation Set to associated nodes in Group 2 when the Nano Switch receives the Basic Set, Switch All, Scene Activation Set commands from main controller.
3	5	Send Basic Set (configured by parameter 82) to the associated nodes in Group 3 when the external switch S1 is operated
4	5	Send Basic Set (configured by parameter 82) to the associated nodes in Group 4 when the external switch S2 is operated

### Configuration Parameters

Z-Wave products are supposed to work out of the box after inclusion, however certain configuration can adapt the function better to user needs or unlock further enhanced features.

same logic applies: Values greater than 32768 may needed to be given as negative values too.

#### Parameter 4: Overheat protection.

*Output Load will be turned off automatically after 30 seconds and if the temperature of product inside exceeds 100°C.*

Size: 1 Byte, Default Value: 0

Setting	Description
0	Disable
1	Enable

#### Parameter 20: Configure the output status after re-power on it.

*Configure the output status after re-power on it.*

Size: 1 Byte, Default Value: 0

Setting	Description
0	Last status
1	Always on
2	Always off

#### Parameter 80: To set which notification would be sent to the associated devices (Group 1)

*To set which notification would be sent to the associated devices (Group 1) when the state of Nano Dimmers load is changed.*

Size: 1 Byte, Default Value: 0

Setting	Description
0	Send Nothing
1	Send Hail CC
2	Send Basic CC report
3	Send Hail CC when using the manual switch to change the load state.

#### Parameter 81: To set which notification would be sent to the associated nodes in association group 3

*To set which notification would be sent to the associated nodes in association Group 3 when using the external switch 1 to switch the loads.*

Size: 1 Byte, Default Value: 1

Setting	Description
0	Send Nothing
1	Send Basic Set CC

#### Parameter 82: To set which notification would be sent to the associated nodes in association group 4

*To set which notification would be sent to the associated nodes in association Group 4 when using the external switch 2 to switch the loads.*

Size: 1 Byte, Default Value: 1

Setting	Description
0	Send Nothing
1	Send Basic Set CC

#### Parameter 83: Configure the state of LED

*Configure the state of LED when it is in 3 modes*

Size: 1 Byte, Default Value: 0

Setting	Description
0	The LED will follow the status (on/off) of its load (Energy mode).
256 - 316	The hour value of ON time
2	Night light mode.

#### Parameter 84: ON/OFF time

*Set the ON/OFF time of the LED when it is in Night light mode.*

Size: 4 Byte, Default Value: 524306

Setting	Description
0 - 60	The minute time of OFF
256 - 316	The hour time of OFF
65536 - 65596	The minute time of ON

## Parameter 86: Set appointment 1

*Set appointment 1*

Size: 4 Byte, Default Value: 2293760

Setting	Description
0 - 60	The minute value of ON time
256 - 316	The minute value of ON time
65536 - 65543	The day value (Mon to Sun)
16777215	Disable the setting.
16777216	Enable the setting.

## Parameter 87: Set appointment 2

*Set appointment 2*

Size: 4 Byte, Default Value: 2293760

Setting	Description
0 - 60	The minute value of ON time
256 - 316	The hour value of ON time
65536 - 65543	The day value (Mon to Sun)
16777215	Disable the setting.
16777216	Enable the setting.

## Parameter 120: Configure the external switch mode for S1.

*Configure the external switch mode for S1.*

Size: 1 Byte, Default Value: 0

Setting	Description
0	Enter automatic identification mode
1	Momentary push button mode
2	3 way switch mode
3	2-state switch mode

## Parameter 121: Configure the external switch mode for S2.

*Configure the external switch mode for S2.*

Size: 1 Byte, Default Value: 0

Setting	Description
0	Enter automatic identification mode
1	Momentary push button mode
2	3 way switch mode
3	2-state switch mode

## Parameter 122: Set the control destination for external switch S1

*Set the control destination of the external switch.*

Size: 1 Byte, Default Value: 3

Setting	Description
1	control the output loads of itself.
2	control the other nodes
3	control the output loads of itself and other nodes.

## Parameter 252: Lock/unlock configuration parameters

*Lock/unlock configuration parameters.*

Size: 1 Byte, Default Value: 0

Setting	Description
0	Unlock
1	Lock

Reset the Nano Dimmer to factory default.  
Size: 4 Byte, Default Value: 0

Setting	Description
0	Reset all configuration parameters to factory default setting
1431655765	Reset to factory default setting and removed from the z-wave network

## Technical Data

Dimensions	0.0390000x0.0420000x0.0200000 mm
Weight	28.67 gr
Hardware Platform	ZM5202
EAN	1220000015050
IP Class	IP 20
Voltage	24V DC/ 230V AC
Load	6,5A
Device Type	Switch
Generic Device Class	Binary Switch
Specific Device Class	Binary Power Switch
Firmware Version	01.01
Z-Wave Version	04.26
Certification ID	ZC10-17035523
Z-Wave Product Id	0x0086.0x0003.0x008b

## Supported Command Classes

- Basic
- Switch Binary
- Switch All
- Scene Activation
- Scene Actuator Conf
- Association Grp Info
- Device Reset Locally
- Zwaveplus Info
- Configuration
- Alarm
- Manufacturer Specific
- Powerlevel
- Firmware Update Md
- Clock
- Association
- Version
- Hail

## Controlled Command Classes

- Hail

## Explanation of Z-Wave specific terms

- **Controller** — is a Z-Wave device with capabilities to manage the network. Controllers are typically Gateways, Remote Controls or battery operated wall controllers.



- **Primary Controller** — is the central organizer of the network. It must be a controller. There can be only one primary controller in a Z-Wave network.
- **Inclusion** — is the process of adding new Z-Wave devices into a network.
- **Exclusion** — is the process of removing Z-Wave devices from the network.
- **Association** — is a control relationship between a controlling device and a controlled device.
- **Wakeup Notification** — is a special wireless message issued by a Z-Wave device to announces that is able to communicate.
- **Node Information Frame** — is a special wireless message issued by a Z-Wave device to announce its capabilities and functions.