



DECKZ

DECKING  
BROCHURE



# A REVOLUTION IN OUTDOOR FLOORING

As an alternative to natural wood decking, Deckz offers a solution that is environmentally friendly, sustainable, and safe, but without the flaws and setbacks of natural wood products. With no need to stain, paint, or treat, Deckz is low-maintenance. Plus, with a wide range of finishes and designs, you're sure to find the perfect complement to your outdoor haven. Just select your desired finish, and this ready to install composite solution can be the final touch to your ideal outdoor space.

## WHY CHOOSE DECKZ?



Our own fleet of  
delivery vehicles



Easy  
installation



Low  
maintenance



Engineered with  
specialised  
carpenters



Environmentally  
friendly

**15-25  
YEARS**

Extended Limited  
Warranty

## DECKZ ASA DECKING EXPLAINED

Deckz have designed an exclusive co-extruded ASA line which takes outdoor flooring to another level, never before though possible!

- It arrives in two pre-cut lengths, for ease of installation (3.6m and 4.8m). Custom sizes upon request.
- A carbonised double protective layer is the best weather resistant resin technology available.
- ASA is incredibly lightweight yet exceptionally strong.
- Does not absorb heat. Easy to walk on.
- In-built fade resistance (0.2% per year).\*
- ASA looks & feels like natural wood.
- 25 year extended limited warranty.\*\*

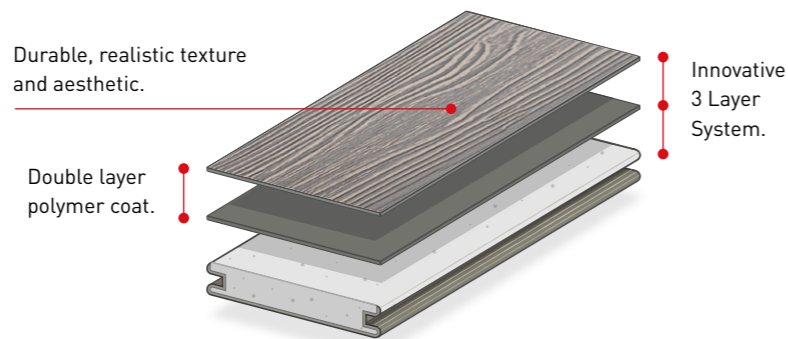

\* Tested estimation.  
\*\* See inside back page for Additional Warranty information.

## DECKZ WPC DECKING EXPLAINED

Designed in consultancy with working carpenters, Deckz WPC is a non polymer wrapped product which is fully re-sandable. It's a popular wood tree fibre and recycled plastic extruded product. With wood fibres taken from Canada, it is extremely hard and durable due to the harsh conditions the trees are designed to endure.

- It arrives in two pre-cut lengths, for ease of installation (3.6m and 4.8m). Custom sizes upon request.
- Re-sandable technology, removing any marks, minor burns or stains.
- All WPC ranges fully reversible.
- Will not rot or warp like wood.\*
- 15 year limited extended warranty.\*\*

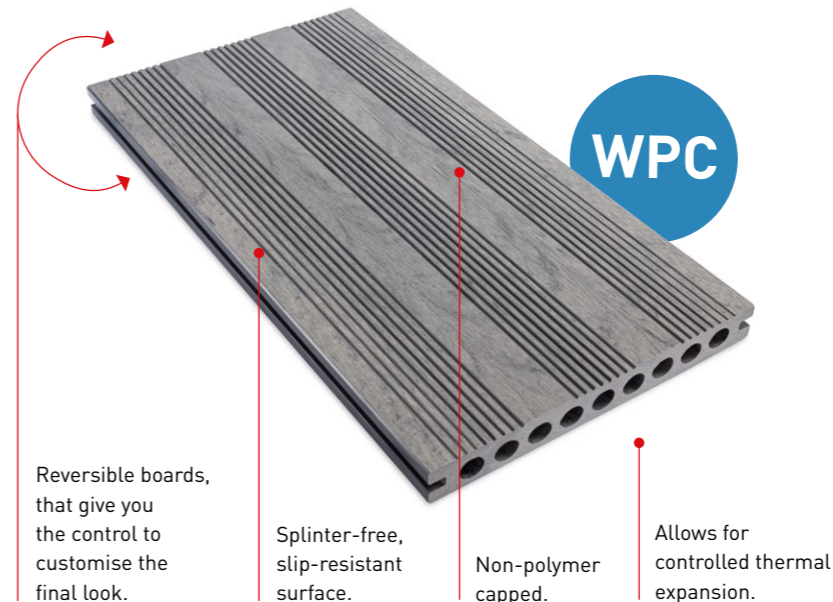

### Deckz WPC board can be sanded

Deckz is solid composite, meaning any scratches or damage can be sanded down, restoring your boards to their original beauty.



\* Correct installation necessary.  
\*\* See inside back page for Additional Warranty information.



LOOKS AND FEELS  
LIKE REAL WOOD

## INTRODUCING

# DECKZ VINTAGE ASA

The new Vintage line reaches new heights in what is possible for decking.

Featuring a durable and lightweight core, each board is capped with a carbonised double protective ASA coating providing unmatched durability against stains, cracking, mould and mildew. Every board is uniquely stunning in appearance and backed by a 25 year warranty.\*

Vintage decking is a bamboo filled PVC decking profile with an ultra durable **engineered acrylic polymer cap** setting new heights for **UV fade protection**. The Vintage decking cap technology has an undeniably realistic appeal and texture as well as boasting immense strength and resistance to the elements.

Vintage Decking: Our most durable, market leading range. Vintage decking range features powder coated aluminium edge finishes for a sleek, minimalistic result.



DIMENSIONS: 135 x 22 x 3600 & 4800mm  
JOIST SPACING: 300mm on centres

WEIGHT: 2.1KG/M  
FASTENERS: Deckz hidden 'Clipz' system

VINTAGE DECKING



CROSS SECTION  
135 x 22mm

DUAL COLOUR  
SINGLE SIDED



VINTAGE  
ARCTIC BIRCH

DIMENSIONS: 135 x 22 x 3600 & 4800mm  
JOIST SPACING: 300mm on centres

WEIGHT: 2.1KG/M  
FASTENERS: Deckz hidden 'Clipz' system

DIMENSIONS: 135 x 22 x 3600 & 4800mm  
JOIST SPACING: 300mm on centres

WEIGHT: 2.1KG/M  
FASTENERS: Deckz hidden 'Clipz' system



CROSS SECTION  
135 x 22mm

DUAL COLOUR  
SINGLE SIDED



CROSS SECTION  
135 x 22mm

DUAL COLOUR  
SINGLE SIDED

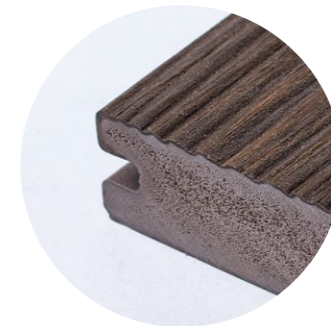

FORTIZ  
CHARRED CEDAR

VINTAGE  
DISTRESSED CHESTNUT

# VINTAGE DECKING

ASA

DIMENSIONS: 135 x 22 x 3600 & 4800mm  
JOIST SPACING: 300mm on centres

WEIGHT: 2.1KG/M  
FASTENERS: Deckz hidden 'Clipz' system



CROSS SECTION  
135 x 22mm

DUAL COLOUR  
SINGLE SIDED

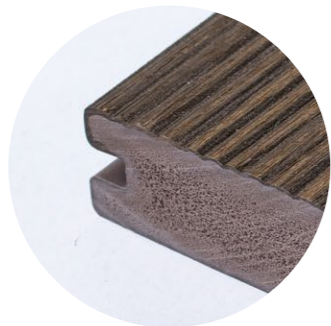

FORTIZ  
OLIVE OAK

VINTAGE DECKING  
LOOKS AND FEELS LIKE REAL WOOD



### THE PERFECT FIT

Vintage finished edge fascias are the perfect way to enclose your decking.



DIMENSIONS: 150 x 12 x 2500mm  
JOIST SPACING: 400mm on centres

WEIGHT: 1.25KG/M  
FASTENERS: Stainless Steels Screws



## VINTAGE FASCIA'S



VINTAGE  
ARCTIC BIRCH



VINTAGE  
OLIVE OAK



VINTAGE  
DISTRESSED CHESTNUT



VINTAGE  
CHARRED CEDAR



# FORTIZ DECKING

WPC

**Beautiful, strong, durable. A robust composite structure, and deep-grooved surface designs makes Fortiz about strength and durability, while still being an unmistakably sharp decking option.**

Fortiz is hard-wearing, with sturdiness and durability at the core of its design. Distinct, high-grip groove patterns on each side of the boards guarantee stability, while also offering complete control over the aesthetic, without compromise. These grooves are uniquely developed in another way: when used with Clipz, Fortiz boards create a perfect ridge pattern. Correctly fitted they line up perfectly, with exact and precise spacing between each and every board; a precise design making for a precise finish.

Fortiz: Strength and beauty in precision.

As with all the ranges, the Fortiz range offer finished edge boards, eliminating need for L-Trim.







FORTIZ DECKING  
STRENGTH AND BEAUTY IN PRECISION



CROSS SECTION  
150 x 25mm x 3600 & 4800mm



FINISHED EDGE  
BOARDS AVAILABLE

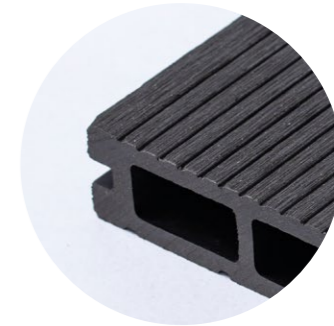

NARROW GROOVE SIDE

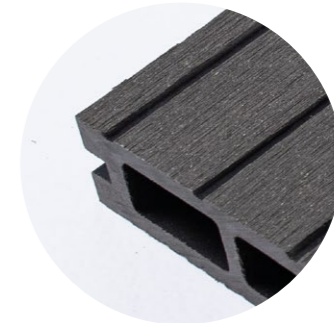

WIDE GROOVE SIDE



FORTIZ  
CHARCOAL



CROSS SECTION  
150 x 25mm x 3600 & 4800mm



FINISHED EDGE  
BOARDS AVAILABLE

**FORTIZ DECKING**



CROSS SECTION  
150 x 25mm x 3600 & 4800mm



FINISHED EDGE  
BOARDS AVAILABLE

**FORTIZ DECKING**



NARROW GROOVE SIDE

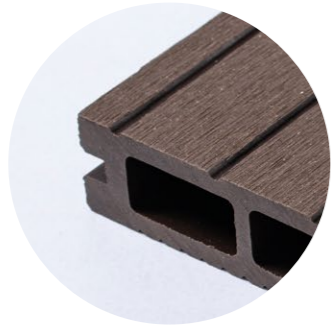

WIDE GROOVE SIDE

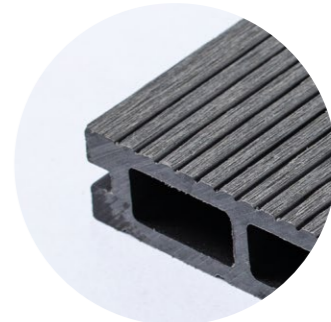

NARROW GROOVE SIDE

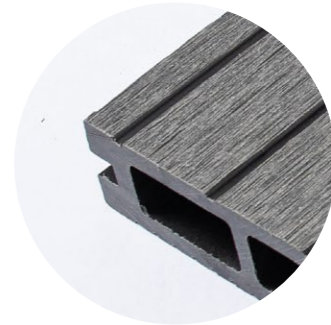

WIDE GROOVE SIDE



**FORTIZ**  
CHOCOLATE

**FORTIZ**  
GRAPHITE



# MODERNO DECKING WPC

**Less is more. Moderno offers sleek reflections of an urban environment, all while retaining the natural beauty and adaptability of wood.**

Moderno's boards are designed wider than any others in the Deckz range, reducing both the time it takes to install and the amount of Clipz needed. Crafted with two grey-tone colours through each and every board, Moderno can be deeply sanded if required to remove scratches and dents, or simply to adjust the aesthetic closer to the image you have of your ideal space. While minimal is key in the way in which Moderno has been designed, each board is reversible, offering two very different effects: smooth and marbled, or a bold, high grip triple-grooved effect.

Moderno: Bold, Urban design with a minimalist edge.

As with all the ranges, the Moderno range offer finished edge boards, eliminating need for L-Trim.

CROSS SECTION  
200 x 25mm



FINISHED EDGE  
BOARDS AVAILABLE





DIMENSIONS: 150 x 25 x 3600 & 4800mm  
JOIST SPACING: 400mm on centres

WEIGHT: 4.7KG/M  
FASTENERS: Deckz hidden 'Clipz' system

**MODERNO DECKING**



SMOOTHER SIDE



GROOVED SIDE

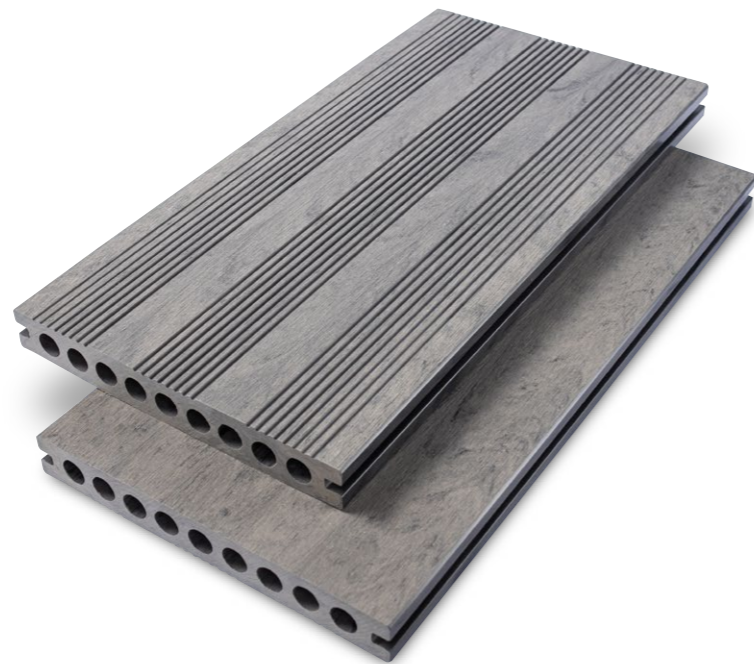

**MODERNO DECKING**



**MODERNO**  
**DUO GREY**



MODERNO DECKING

MODERNO DECKING

BOLD, URBAN DESIGN WITH A MINIMALIST EDGE

# SUBFRAME

Deckz supply Aluminium Sub-Structures to suit most applications.

The benefits of using Aluminium over timber sub-frames is longevity & strength without movement.

Timbers over time will rot. Even though the joists are not seen, using a composite decking board which is designed to perhaps last 25 years, on top of timber which will not last a quarter of this lifespan, makes us here at Deckz enthusiastic to educate on alternative solutions.

Deckz design and supply aluminium sub-structures which can be used on flat roofs with low height requirements.

We also supply systems that can be used on gravel beds, concrete or existing patio flags.

## Why we recommend Aluminium

Timber Joists & Sub-frames naturally absorb water. This leads to rot and decay. It also leads to movement, contraction and expansion due to heat and water absorption. Movement underneath a deck although a slow process, can put undue pressure on the surface above and encourage deck board movement.

## Please Note

Modern day timbers due to demand are not always seasoned long enough. This leads to timber sub-frames constructed 'wet' & 'young'. Once seasoned and dry, the timbers shrink back and this leads to sub-structure movement. This can lead to top surface board movement. If installing timber sub-structures please use well seasoned timber and install dry. **Never install top surface boards onto a wet substructure.**

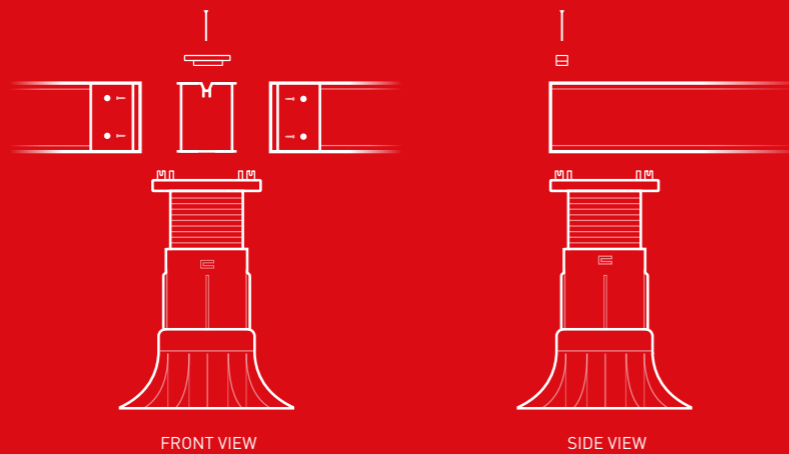



# CLIPZ

Made in the UK from durable, 100% recycled materials, they are purposefully designed to fit perfectly and near-invisibly with all Deckz decking.

While Clipz are made to universal specifications, and can therefore be used with other decking manufacturers, they have been streamlined to work with Deckz in a specific way.

Each Deckz board has a 6mm groove along its side, into which Clipz fit perfectly. The 6mm overhang also allow Clipz to be used to tie edging boards in. So, not only do they hold the boards side-by-side, but also at a 90° angle too. Clipz are available in 3 colours (brown, grey and black) so they can work seamlessly with whatever design has caught your eye.

**Please Note:** Where 2 boards meet, 6mm expansion should be left. Call 0800 002 9887 for info as it is weather dependant. 2 joists should be used where 2 boards meet, 1 clip at the end of each board that meet. **Do not** span 1 clip across 2 end boards.

GRAPHITE



BROWN



BLACK



Colours may vary.  
An exact match with your decking is not necessary.

**PATENTED DESIGN** Snap off expansion pegs allow for thermal contraction & expansion in all directions.





# L-TRIM WPC

**Deckz WPC L-Trim (or corner trim) is a fully composite way of finishing the edges of your brand new Decking or Cladding.**

Deckz L-Trim is deeper and thicker than other brands. This means you can drill and counter sink screws for an invisible level of security not offered by other L-Trims. It is designed to fit seamlessly with our products, and create a visual effect that is minimal, and stunning.

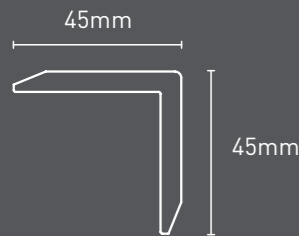

CHOCOLATE

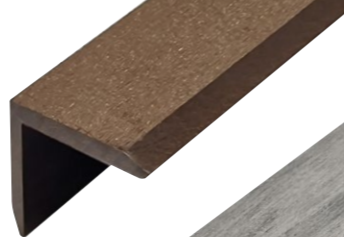

DUO GREY



GRAPHITE



CHARCOAL



# L-TRIM ASA

**Deckz Powder Coated Aluminium L-Trim (or corner trim) is a market leading premium corner profile, which leave a crisp edge on your new deck or cladded building.**

Aluminium is tough and lightweight! This premium product will not be prone to splitting or extreme fading. This is a level of L-Trim not seen before, and has been designed & manufactured by Deckz engineers.

This is the **ultimate** in L-Trim.

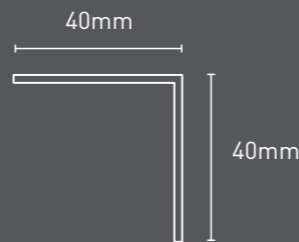

DISTRESSED CHESTNUT

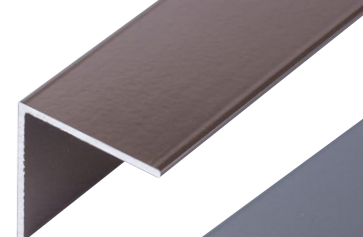

ARCTIC BIRCH



CHARRED CEDAR



OLIVE OAK

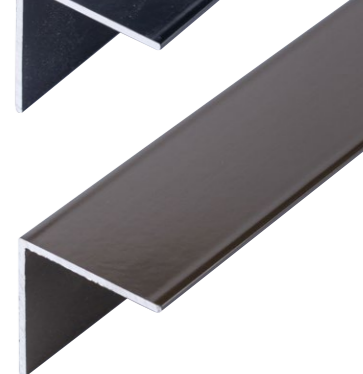

# DESIGN AND INSTALLATION

We have a trained, in-house design team ready to help you plan, and execute your installation. Our team of professionals can assist you through the entire project from start to finish, which can include liaising with your contractor, enabling you to communicate your exact vision for your space, giving you more control in the process and outcome. Our plans and design team will equip you or your contractor with the know-how to successfully install Deckz.

Alternatively, if you decided to install our products yourself, we have a brief guide of how each aspect of the Deckz installation system works.

Do you have a query about our product range, or would you like to arrange a consultation?

**Additional warranty:** Please note that warranty is conditional on correct and proper installation. Installation and ownership instructions as well as warranty information can be found on our website at [deckz.co](http://deckz.co)

**Move one step closer to your perfect outdoor space, and contact us on 0800 002 9887.**

## STARTER FIXING CLIP

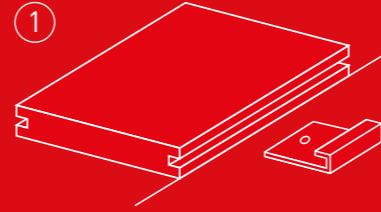

Our carefully engineered starter clip is designed to be used on end boards, steps etc. It secures and locks in the board seamlessly.

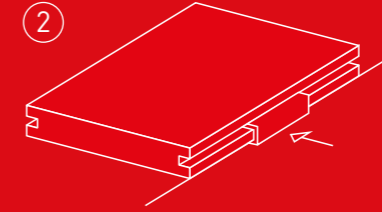

The stainless steel fixing locks into the board's internal clip groove. The fixing is firstly screwed down to each joist (300mm or 400mm centres), then the board is pushed into the clip.

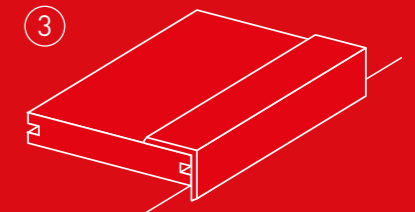

The fixing is very sleek and seamless. However, to hide the end fixings, an L-Trim can be used over the edge of the board as shown.

## BOARDS & JOISTS

Constructing your sub-frame system & installing your top decking boards correct is **KEY** to a long lasting & successful decking area.

Correct size joists and the spacing and layout of them is what separates our designs & advice from our competition. Information on joist spacing and expansion gaps can be found in this brochure and our installation guides.

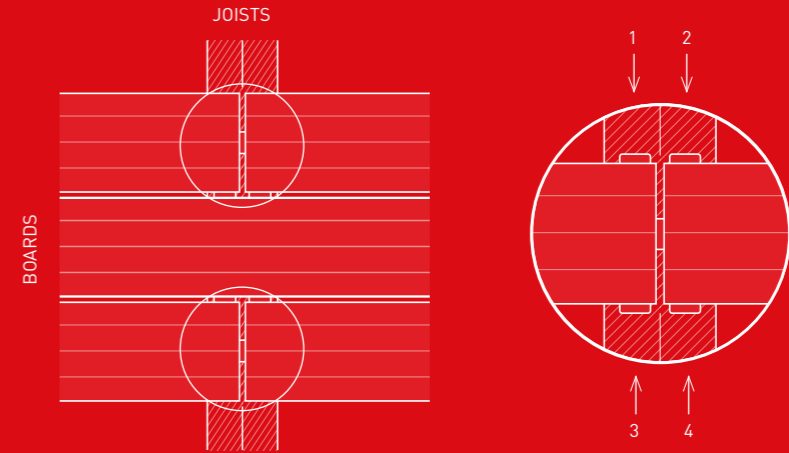

Where a decking board joint occurs and 2 boards meet you must use 2 joists in the substructure side by side. Equally you must use one Deckz Clipz at the end of each board as shown.

**Note:** 6mm minimum expansion gap must be left at the end of each board. More explained on the next page.

150 x 47mm or 6" x 2" treated timbers minimum required.

## EXPANSION GAPS

Deckz products are made from the most robust and premium materials available. Our thermal expansion is controlled to the highest level.

However **ALL** products in our day-to-day lives such as doors and windows expand and contract based on thermal temperatures. Decking is no different.

Deckz products need a 6mm thermal expansion gap leaving at the ends of all the boards. This can occur where a composite decking board meets a wall, a step or another board.

Most companies do not advise on the need to allow for thermal expansion. However at Deckz, we have an eye for detail and want to ensure perfection and longevity.

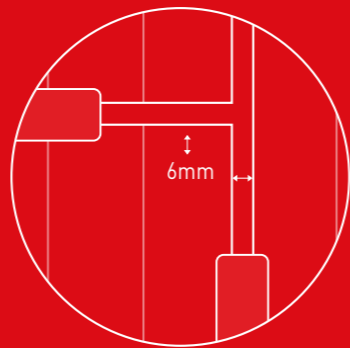
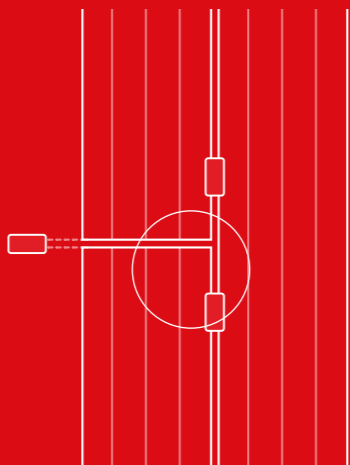

This magnified illustration shows a uniformed 6mm spacing assisted by using a Deckz Clipz.

To help have a uniformed 6mm expansion gap around the entire decking project, we recommend using one of our Deckz Clipz as a spacing guide.

Using a Deckz Clipz at the end of decking boards temporarily, will ensure a 6mm spacing joint between 2 boards.

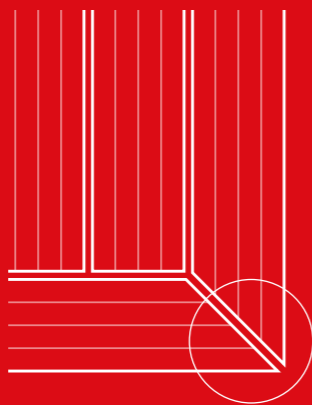
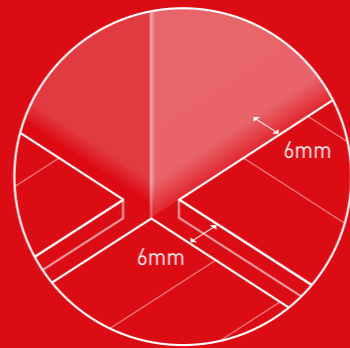

If using a border in your design, remember to still use a 6mm thermal expansion gap wherever boards meet.

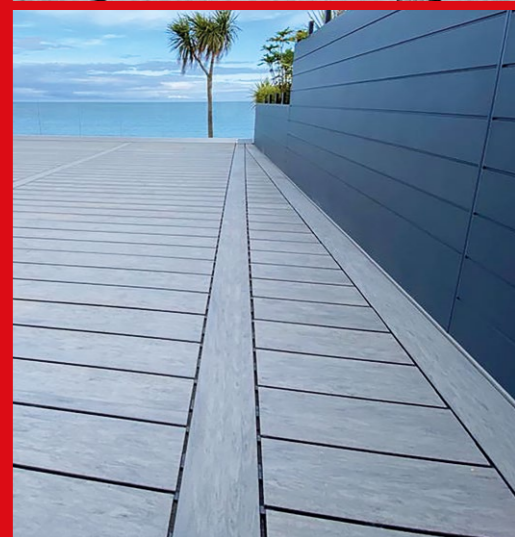

0800  
002  
9887

DECKZ.CO

