

**TOTAL
CONTROL
SYSTEMS**

700-15 Rotary Meter

"The Standard of Measurement"

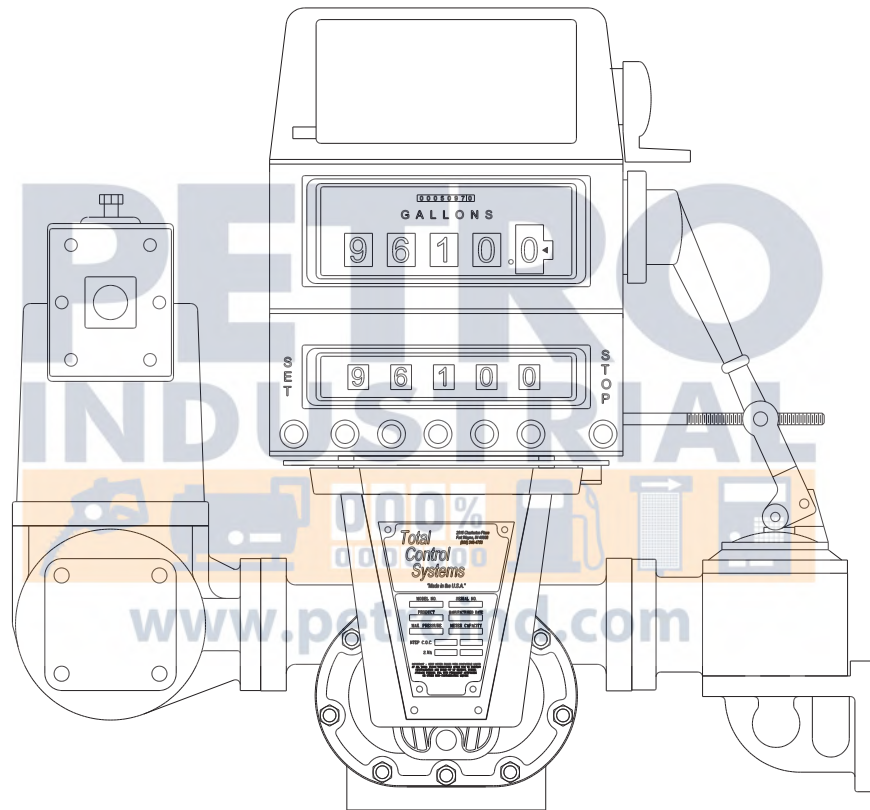

Installation, Operation & Maintenance Manual

Table of Contents

Safety Warning Symbols	2	Hydraulic Preset Valve Assembly	26
Receipt & Inspection	3	Hydraulic Preset Valve Assembly (Continued)	27
Notice	3	Back Pressure Check Valve Assembly	28
Meter Overview	4	Torque Specifications	29
Meter Specifications	5	Drive Components	30
Meter Types	5	Disassembly of Meter	31
Material of Construction	6	Disassembly of Meter (Continued)	32
System Recommendations	6	Disassembly of Meter (Continued)	33
System Recommendations (Continued)	7	Inspection of Parts	34
System Recommendations (Continued)	8	Reassembly of Meter	35
Above Ground Storage System	9	Reassembly of Meter (Continued)	36
Mobile Fueling System	10	Reassembly of Meter (Continued)	37
Start Up Recommendations	11	Reassembly of Meter (Continued)	38
Start Up Recommendations (Continued)	12	Disassembly of Strainer	39
Direction of Flow	12	Reassembly of Strainer	39
Meter Calibration	13	Disassembly of Air Eliminator	40
Meter Calibration (Continued)	14	Reassembly of Air Eliminator	40
Meter Calibration (Continued)	15	Disassembly of Hydraulic Preset Valve	41
Calibration Adjustment	15	Disassembly of Hydraulic Preset Valve (Continued)	42
Split Compartment Testing	16	Reassembly of Hydraulic Preset Valve	42
Split Compartment Testing (Continued)	17	Meter Trouble Shooting	43
Split Compartment Testing (Continued)	18	Air Eliminator Trouble Shooting	44
Maintenance	19	Hydraulic Preset Valve Trouble Shooting	45
Maintenance (Continued)	20	Material Safety Data Sheet	46
Storage Instructions	20	MSDS (Continued)	47
Dimensions	21	MSDS (Continued)	48
Meter Assembly	22	MSDS (Continued)	49
Meter Assembly (Continued)	23	Notes	50
Air Eliminator & Strainer Assembly	24	Warranty	51
Air Eliminator & Strainer Assembly (Continued)	25		

Warning Symbols



CAUTION

Follow the warning instructions within the following information to avoid equipment failure, personal injury or death.



TURN POWER OFF

Before performing any maintenance, be sure to turn system power off to avoid any potential electric spark



FLAMMABLE

Flammable liquids and their vapors may cause a fire or explosion if ignited.



EYE PROTECTION

Pressurized systems may cause hazardous leaks and spray that may be dangerous for your eyes. Always wear eye protection around pressurized systems and its hazardous liquids.



INJURY

Wear gloves for protection from hazardous liquids that may cause irritation or burns.



READ

Read and understand all related manuals thoroughly. The Engineering and OIM manuals will provide the knowledge for all systems, maintenance and operation procedures. If you have any questions, please consult the factory.

Receipt & Inspection

Upon receipt of meter shipment, be sure to inspect the packaging and the flow meter assembly for any damage before signing the receipt of the shipment. Notify the delivery company about possible damage and refuse receipt of the shipment.

Meters are individually boxed and are protected with packing material. Each package is identified with the flow meter assembly part number, description, direction of flow and serial number. Verify the meter model is the correct model, size, and configuration as ordered. Contact your distributor if there is any discrepancy or question.

Meter assemblies should be handled with appropriate methods for the awkwardness of size and weight involved. Appropriate clothing and shoes need to be utilized. Transport the meter package to the installation site with appropriate transportation methods, careful not to damage the flow meter.

Be careful of any loose or protruding staples from the packaging, as they can be very sharp and may potentially cause injury.

If foam has been used to protect meter, carefully remove top foam layer before attempting to remove meter assembly from box. Foam packaging maybe formed around the meter assembly making it difficult to remove. If meter is bolted upon a wood pallet remove bolts while being careful not to let the meter tip over when the support has been removed. Do not lift the meter assembly by flex hoses, thermowells, wires, pulsers, or put objects through meter. Removing meter assembly from packaging without adhering these warnings may cause serious injury.

The wooden pallets and bases meet the ISPM 15; Guidelines for Regulating Wood Packaging Material in International Trade through the Timber Products Inspection Company (TP #2134).

Every effort has been made to remove the calibration fluid before shipment. All TCS flow meters are plugged and enclosed in a plastic bag. A Material Safety Data Sheet (MSDS) can be reviewed on PAGE 46. Appropriate precautions should be taken regarding any personal, environmental and material compatibility with the end use system.

Flow Meter Identification Plate

The image shows a 'Flow Meter Identification Plate' form. At the top, it reads 'TOTAL CONTROL SYSTEMS' with a logo. Below this, there are several fields for identification: 'MODEL NUMBER', 'SERIAL NUMBER', 'DIRECTION OF FLOW', and 'METER ASSEMBLY'. There are also fields for 'FLOW RATE', 'METER SIZE', and 'METER TYPE'. At the bottom, there is a CE mark and the text 'Made in the USA'.

Notice

Total Control Systems (TCS) shall not be liable for technical or editorial errors in this manual or omissions from this manual. TCS makes no warranties, express or implied, including the implied warranties of merchantability and fitness for a particular purpose with respect to this manual and, in no event, shall TCS be liable for special or consequential damages including, but not limited to, loss of production, loss of profits, etc.

The contents of this publication are presented for informational purposes only, and while every effort has been made to ensure their accuracy, they are not to be construed as warranties or guarantees, expressed or implied, regarding the products or services described herein or their use or applicability. We reserve the right to modify or improve the designs or specifications of such products at any time.

TCS does not assume responsibility for the selection, use or maintenance of any product. Responsibility for proper selection, use and maintenance of any TCS product remains solely with the purchaser and end-user.

All rights reserved. No part of this work may be reproduced or copied in any form or by any means – graphic, electronic or mechanical – without first receiving the written permission of Total Control Systems, Fort Wayne, Indiana USA.

Meter Overview

The TCS Model 700 series flow meter is a simple and efficient design. The meter consists of a single fluid chamber that contains a single blocking rotor and two displacement rotors whose rotation is synchronized with mating gears. As the fluid enters the fluid chamber, the blocking rotor is forced to rotate. The displacement rotors, also rotating in conjunction with the blocking rotor help direct the fluid flow through the chamber and to the outlet. The linear flow of the fluid is thus translated into rotary motion in the meter. The output of the meter is picked up from the rotation of the blocking rotor and transmitted to a register or pulse transmitter.

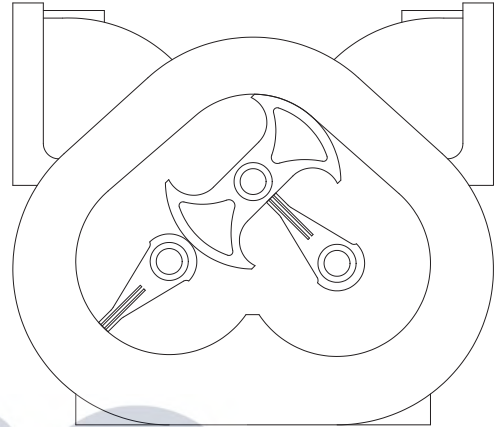

The rotors in the meter are designed to operate at close tolerances to one another and the wall of the fluid chamber. There are slight clearances between the rotors and the chamber wall. Because of this, it is important that the meter be properly applied for the flow rate and operating pressure of the system.

Because the fluid flowing through the meter is redirected only slightly from its natural flow, there is very little pressure drop across the meter, unlike other meters that use multiple measuring chambers.

The meter design uses high performance materials for the rotor bearings and journals. Since there is no contact between the rotors and the fluid chamber wall, these critical components have a long life expectancy.

Calibration of the meter involves adjusting the rotation of the output shaft relative to the rotation of the internal rotors of the meter. This is accomplished by changing the settings on an adjuster device. Calibration of the meter is discussed in detail in the section Meter Calibration.

FLOW ILLUSTRATION

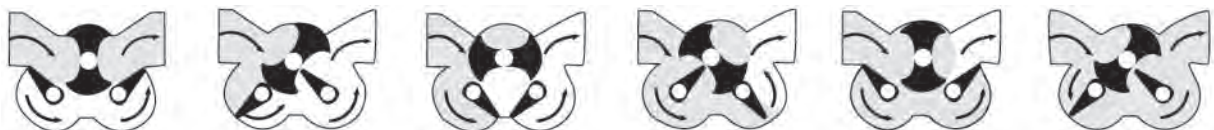

Meter Specifications

Flange Connection:	1-1/2" NPT Flange Connection, 2" NPT Flange. Optional BSPT, Slip Weld or ANSI flanges available upon request.
Flow Rate:	700-15 up to 60 GPM (227 LPM)
Maximum Pressure:	150 PSI (10.5 BAR)
Working Temperature:	-20 F to 160 F (-28.9 C to 71 C)

Meter Types

SP - Standard Petroleum

For metering refined petroleum products such as Leaded and Unleaded Gasoline, Fuel Oils, Diesel, Bio-Diesel, Kerosene, Jet Fuels, Vegetable Oils, Motor Oils, Ethylene Glycol (Antifreeze), etc.

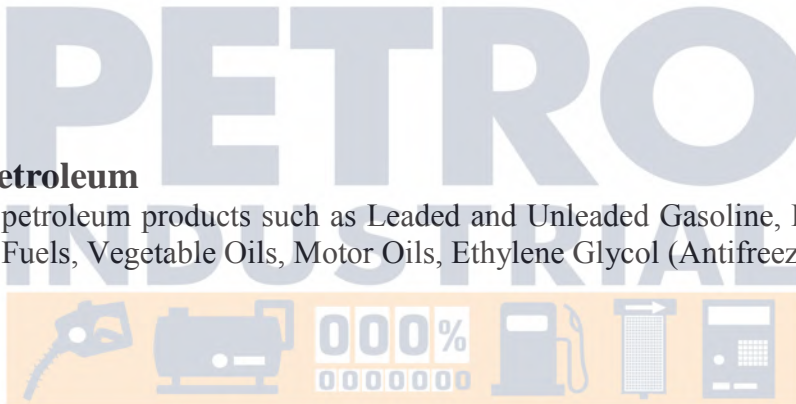

SPA - Standard Petroleum (Aviation)

For metering refined petroleum products such as Aviation Gasoline, Fuel Oils, Jet Fuels, Gasoline, Diesel, Bio-Diesel, Kerosene, etc.

IP - Industrial Products

For metering Industrial Chemicals, General Solvents and many other liquids; such as Liquid Sugars, Corn Syrup, Soy Bean Oil, Shortenings, Latex Products, Adhesives, etc.

IC - Industrial Products (Carbon Bearings)

For metering Industrial Chemicals, General Solvents, Water and other Non-lubricating Liquids, such as Alcohol, Acetones, Ethanol, Naptha, Xylene, MEK, Toluene, Deionized Water, Demineralized Water, Potable Water, etc.

Material of Construction

Description	SP	SPA	IP	IC
Housing	Hardcoat Anodized Aluminum	Hardcoat Anodized Aluminum	Hardcoat Anodized Aluminum	Hardcoat Anodized Aluminum
Rotors	Hardcoat Anodized Aluminum	Hardcoat Anodized Aluminum	Hardcoat Anodized Aluminum	Hardcoat Anodized Aluminum
Rotor Journals	Plated SS	Plated SS	Plated SS	Plated SS
Bearing Plates	Ni-Resist	Ni-Resist	Stainless Steel	Ni-Resist
Bearing Sleeves	Ni-Resist	Carbon Graphite	Non-Galling SS	Carbon Graphite
Timing Gears	Stainless Steel	Stainless Steel	Stainless Steel	Stainless Steel
Packing Seal	Viton®	Viton®	Simriz®	Simriz®
Body O-rings	Viton®	Viton®	Teflon®	Teflon®

Viton® is a registered trademark of E.I. DuPont de Nemours & Co.
 Simriz® is a registered trademark of Freudenberg-NOK.
 Teflon® is a registered trademark of Dupont Dow Elastomers, L.L.C.

System Recommendations



Meter Selection

The flow meter must be carefully chosen from the Meter Selection factors in the Engineering Manual. The meter must be selected based on the operating system and product characteristics. System variables include flow rate, temperature and pressure. The product characteristics include the material compatibility, lubricity, viscosity, suspensions, pH, and whether the product can congeal, crystallize or leave a dry film. Failure to select the correct flow meter may result in system failure or serious injury.

Air Elimination

In any system that the tank may be completely drained or multiple products manifold into one metering system, the possibility of air being present increases. The solution is an air or vapor eliminator located before the flow meter to vent the air or vapor from the system before it can be measured. Air or vapor elimination is required for all weights and measures regulatory approvals in custody transfer applications.

System Recommendations (Continued)



Control Valves

Safety and isolation valves should be used throughout the metering system. In any pumping system where there is one (1) pump and multiple flow meters, a digital or hydro-mechanical Rate-of-Flow control valve must be used at each flow meter to prevent over speeding of the flow meters.

Best Plumbing Configuration

- 1). Flow meter must have secure mounting to a riser or foundation
- 2). The inlet and outlet piping must be securely supported, in a manner of not to allow pipe stress on flow meter.
- 3). System should be designed to keep the flow meter full of liquid at all times.
- 4). System piping should have full 1-1/2" pipe diameter throughout the metering system to allow for minimal pressure loss.
- 5). The pipe should be laid out as straight as possible to reduce pressure loss from flow restriction.
- 6). The meter and piping must be installed in such a way as to avoid accidental draining of the meter. Meter inlet and outlet should be lower than the associated system plumbing (sump position).
- 7). It is not necessary for the air eliminator to be installed bolted directly to the meter. It can be installed upstream from the meter. For effective operation of the air eliminator, it should be mounted between the meter and any valves, tees or any other potential places where air may enter the system.
- 8). The metering system should include a means for calibration.

Protection From Debris

On new installations, care must be taken to protect the meter from damage during start-up. It is recommended to put a strainer before the meter. Damage may result from the passage through the meter of dirt, sand, welding slag or spatter, thread cuttings, rust, etc. The insertion of a spool (a flanged length of pipe equal in length to the meter and accessories attached to the meter) in place of the meter until the system is flushed, temporarily bypassing the plumbing around the meter, will also protect the meter from debris. Once the system has run "clean" for a period of time the meter may be reinstalled or protective devices removed.

Thermal Expansion

As with most liquids, they will expand and contract with temperature. In any system where there is a chance for liquid to be captured between closed valves without relief, thermal expansion will likely occur and create dangerously high pressures within the system. Care should be taken in designing the system in which thermal shock may occur by implementing Pressure Relief Valves or Thermal Expansion Joints in the system design.

When product is trapped within the system, the pressure will increase by 126 PSI (8.69 BAR) for every one (1) temperature degree increase.

System Recommendations (Continued)



Thermal Shock

The system operating temperature will expand or contract the metals within the flow meter. For systems that have sudden or immediate temperature increases of 68 F (20 C) degrees or more, will require clearance rotors. Clearance rotors will be necessary to eliminate the effect of immediate expansion of the rotors vs. meter body, caused by thermal shock.

Hydraulic Shock (Water Hammer)

Hydraulic shock is a rise in pressure, which happens when an operating system has immediate change in direction of flow such as a fast valve closure at a high operating flow rate. Hydraulic shock can damage any item in the way of the product flow such as internal parts of the meter, valves, and pump. System design and improper operating procedures will elevate this problem. The use of 2-stage preset control valves or surge suppressing bladders or risers will help reduce or eliminate this problem.

To compute the shock pressure when a valve is closed quickly (recommended to be less than 6 PSI):

$$\text{Shock Pressure (PSI)} = 63 \times \text{Velocity (FPS)}$$

In order to eliminate hydraulic shock, you need to slow down the valve closure rate. The time required to close the valve so that the line pressure will not exceed the normal pressure at no flow is:

$$\text{Time (seconds)} = \frac{0.027 \times L \times V}{N - F}$$

V = Velocity in Feet/Seconds

L = Length of pipe before the valve in feet

N = Line pressure at no flow

F = Line pressure at full flow

Products that Dry/Congel/Crystallize

There are many liquids that crystallize, harden and/or solidify on contact with air or with an increase in temperature. A proper system design and a good understanding of the product being measured will help to avoid the possibility of air entering into the system and the product being affected.

Calibration

The meter shall be tested and calibrated with the product it is intended to measure when installed. Total Control Systems shall not be responsible for loss of product or any damages resulting from the end user's failure to test this meter to insure proper calibration. Every 700 series meter is tested and calibrated at the factory to prove it is calibratable in your system. It is the owner's responsibility to report this device to the local Weights and Measures officials for their inspection before the meter is put to use.

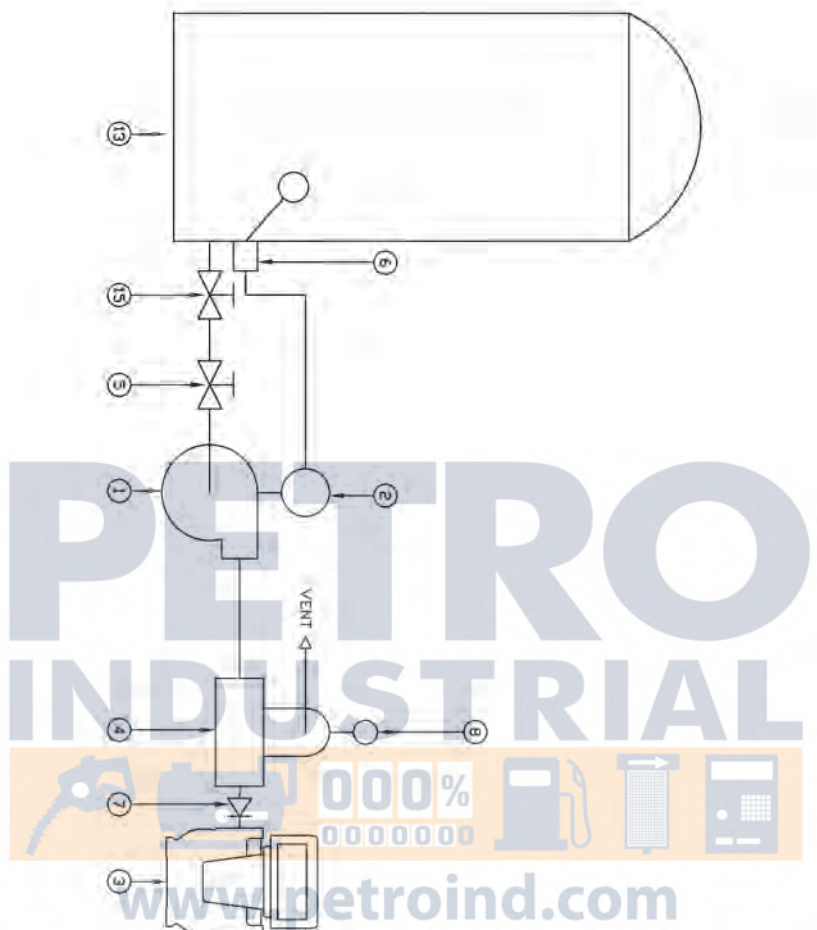

PARTS LIST

ITEM	DESCRIPTION
1	PUMP
2	PUMP MOTOR
3	FLOW METER W/ REGISTER
4	STRAINER/VAPOR ELIMINATOR
5	ISOLATION VALVE
6	LIQUID LEVEL CONTROL DEVICE (OPTIONAL)
7	CHECK VALVE
8	PRESSURE GAUGE (OPTIONAL)
9	TEMPERATURE GAUGE (OPTIONAL)
10	FLOW RATE CONTROL VALVE
11	CHECK VALVE
12	FILL NOZZLE
13	SUPPLY TANK
14	PRESET VALVE (OPTIONAL)
15	SAFETY VALVE

CONDENSATION THERM AIR COMPRESSOR AND PROPRIETARY TO MURRAY EQUIPMENT, INC. THE DRAWING MAY NOT BE COPIED OR REPRODUCED TO OTHERS WITHOUT EXPRESS WRITTEN PERMISSION OF MURRAY EQUIPMENT, INC.

FOR
TOTAL CONTROL SYSTEMS
A DIVISION OF
MURRAY EQUIPMENT, INC.

DATE 08/16/06
REV. SEP 06

DRAWING NUMBER
TCS00111

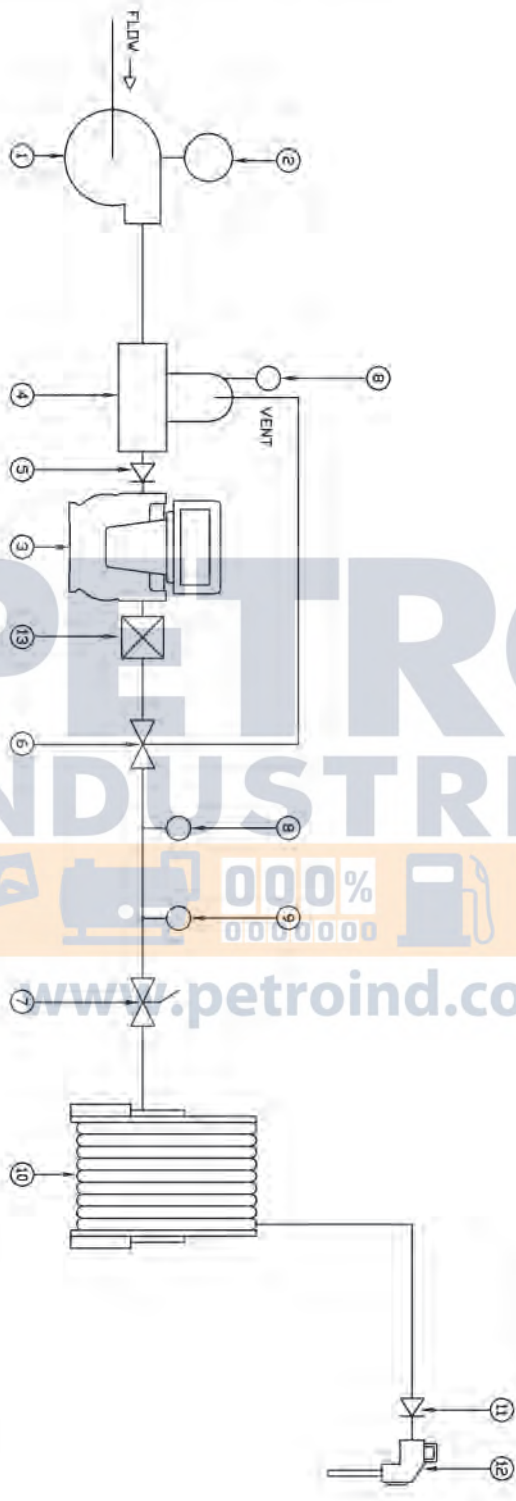

PETRO INDUSTRIAL

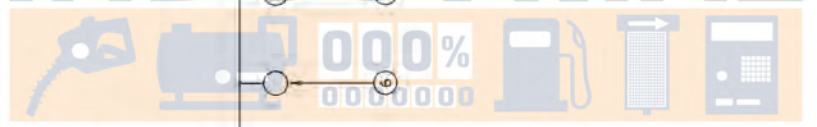

www.petroind.com

PARTS LIST

ITEM	DESCRIPTION
1	PUMP
2	PUMP MOTOR
3	FLOW METER W/ REGISTER
4	STRAINER/VAPOR ELIMINATOR
5	CHECK VALVE
6	AIR CHECK VALVE (OPTIONAL)
7	FLOW RATE CONTROL VALVE
8	PRESSURE GAUGE (OPTIONAL)
9	TEMPERATURE GAUGE (OPTIONAL)
10	HOSE REEL
11	CHECK VALVE
12	FILL NOZZLE
13	PRESET VALVE (OPTIONAL)

THIS DRAWING AND THE INFORMATION CONTAINED THEREIN ARE CONFIDENTIAL AND PROPRIETARY TO MURRAY EQUIPMENT, INC. THE DRAWING MAY NOT BE COPIED OR DISCLOSED TO OTHERS WITHOUT EXPRESS WRITTEN PERMISSION OF MURRAY EQUIPMENT, INC.

MOBILE LIQUID-MEASURING SYSTEM

FOR

TOTAL CONTROL SYSTEMS
A DIVISION OF
MURRAY EQUIPMENT, INC.

DATE: 08/16/06
DRAWN BY: SEP
REV: INC.
DRAWING NUMBER: TCS00112

MURRAY EQUIPMENT, INC.
A DIVISION OF
MURRAY EQUIPMENT, INC.

Start up Recommendations



!WARNING!

Test equipment should be grounded to prevent a possible spark. Test area should have no ignition source. Operators should wear personal protection and prevent any product exposure and environmental issues.

Start-up instruction for new installations or after maintenance and repairs:

- 1). Only properly trained personal should design, install, or operate metering system.
- 2). Remove plastic threaded plugs placed in meter for shipping protection. They are not to be used in meter system because of the PVC plugs low rated pressure, compatibility, and sealing issues.
- 3). Place the meter in an area with ample workspace, secure from vibration, and pipe line stress. Mount and bolt down on to a fixed stand or platform. This prevents meter stress, which will cause leakage and metal fatigue.
- 4). Apply thread sealing compound and gasket materials that are compatible with product.
- 5). Do not weld to meter or accessories. This will weaken housings and cause o-ring and casting leaks and potentially distort the critical tolerances within the flow meter.
- 6). Always wear personal safety protection equipment such as goggles, steel toed shoes, gloves and full body clothing.
- 7). Be sure to install a pressure relief valve or expansion joint in the system to protect against thermal expansion.
- 8). Make sure all system components are properly secured and tightened.
- 9). All meter assembly bolts and connections are tight.
- 10). Air eliminator vapor release is properly vented and piped into a reservoir container or back to the supply tank.
- 11). Electrical connections are properly installed and start/stop switches are off and locked-out.
- 12). Flooded suction to the Pump. Fluid is available to system and will not starve or cavitate pump.
- 13). Slow flooding of system

Start up system with all shut off valves in the closed position. When a pump is turned on and a valve opened in a new, dry system, tremendous liquid and air pressure can be built up in the piping and forced through the meter. The high pressure and volume of air causes the meter to operate more quickly than normal. When product reaches the meter, there is an abrupt slowing of the meter rotors, which could cause damage to the register, rotor shafts, packing gear and/or blade, timing gears and other components. *The recommended method of starting any system is to flood the piping gradually. This allows product to slowly force the air from the entire system.*

Start-Up Recommendations (CONTINUED)



- 15). When operating the meter with accessories, valves should be opened slowly to avoid a pressure surge that can damage the meter or air eliminator. System pressures should be maintained below 70 PSI (4.9 BAR).
- 16). Custody transfer metering systems must be calibrated by a regulatory agency before product can be sold off the meter. Contact your local authorities for proper calibration.
- 17). Strainers should be cleaned frequently or have a maintenance schedule. This will ensure a clean system and long service life.

Direction of Flow

The meter is set up at the factory for left to right flow. To change the meter to right to left flow, begin by removing the screws (#9 on the Meter Assembly Breakdown) and the adjuster cover plate (#7) on the front of the meter. Remove both the screws (#1), the drive shaft retainer (#10), the drive shaft (#3), the e-ring (#4) and the face gear (#5). Reinstall the gear on the shaft with the gear teeth facing up. Snap the e-ring back into place to hold the gear in place. Reinstall the shaft, mating the face gear with the drive gear of the packing capsule assembly. Reinstall the screw and cover plate. The meter will now be set up for right to left flow. See Page for a parts breakdown of entire meter assembly.



Meter Calibration



The method of proving should be selected, and necessary provisions made, during the design stage of the installation. Of the most common used systems, portable provers have the advantage of more closely reproducing the condition under which the product is normally delivered.

Use Accurate Prover

Scientifically designed provers are commercially available for proving meters, and no other kind should be used. Even scientifically designed provers should be checked periodically for accuracy. Weights and Measures officials have been very cooperative in giving assistance to checking privately owned volumetric provers.

Recommended size of test measure:

The prover capacity should be equal to at least one minute's flow through the meter at its maximum rate.

These provers are not merely truck compartments or drums, but are scientifically designed test measures, having proper drainage means built into them, a calibration gauge glass neck, and protection against deformation (which causes volume changes).

A "homemade" prover, whether a drum or a tank is not likely to be satisfactory, and may cause expensive errors due to inaccurate meter calibration.

Setting a Prover

The prover should be set level, using the levels provided on the prover, or separate ones. This insures consistent results when moving the prover from meter to meter.

Where to Test a Meter

The best place to test is in its normal operating position, instead of a test stand. In this way, the correctness of the installation and of the operation conditions will be verified by the test. Always test a meter with the same liquid it is to measure, because a difference in viscosity, temperature and system plumbing slightly affects meter accuracy.

Discharge Line from Meter

Where a portable prover is used, the liquid is generally discharged in to the prover in the same manner, as a normal delivery would be made. Where a special test connection is used, the discharge line must be arranged to drain to the same point on each test. The meter flow rate and off/on is controlled at the end of the discharge line.

Wetting the Prover

Reset the meter register to zero, and fill the prover to the zero or 100% marking of the scale. Disregard the meter reading. Drain the prover, and reset the register. The reason for disregarding the first meter reading is that the prover must be wetted, as its calibrated capacity is determined on its wet measure capacity by its manufacturer, and because the prover will be wet for the subsequent tests to be run.

Meter Calibration (Continued)



After the prover has drained, allow a definitive time of a few minutes for drainage from the sides of the tank. Total drainage time should be the same between all tests to insure uniform results. If a considerable length of time is to elapse between tests, the wetting operation can be eliminated by allowing the prover to remain full until the next test is to be run.

Making the Tests

The setup is now ready for accuracy the test. Reset the register to zero, and run the required test through the meter. Do not exceed the maximum recommended rate of flow for the meter. Maximum and minimum recommended rates of flow for various sizes and types of 700 series meters are marked on their identification plates and maintenance manuals.

Determining Test Results

Run the meter to the mark on the dial corresponding to the prover capacity, and read the over or under delivery in cubic inches or percent on the calibrated plate on the neck of the prover. If the plate is calibrated in cubic inches, the percentage error can readily be computed on the following basis:

- (a) One gallon equals 231cu.in.
- (b) A 100-gallon prover holds 23,100cu.in. Therefore, 23.1cu.in. represents 0.1% error.

The National Institute of Standards and Technology, in its NIST Handbook 44 specifies a tolerance of plus or minus the following:

METER TOLERANCE

Indication of Device	Tolerance		
	Acceptance Test	Maintenance Test	Special Test
Wholesale	0.2%	0.3%	0.5%
Vehicle	0.15%	0.3%	0.45%

Acceptance tolerances apply to new meters and repaired meters after reconditioning.

Repeatability

When multiple tests are conducted at approximately the same flow rate and draft size, the range of test results for the flow rate shall not exceed 40% of the absolute value of the maintenance/normal tolerance and the results of each test shall be within the applicable tolerance.

Changing Meter Calibration

Refer to meter literature for method of changing meter calibration. Any change in the meter calibration adjustment will change the delivery in the same amount for all rates of flow. That is, the calibration curve retains its shape, but is moved up or down. Therefore, if a meter tests satisfactorily at full flow, but drops off too much at low flow, changing the calibration will not remedy this condition; it will bring the low flow test to 100%, but it will also bring the full flow above 100% by the same amount that the low flow was raised. A condition of this kind is caused either by the metering system, need for meter cleaning or repairs, or because of an attempt to retain accuracy below the minimum recommended rate of flow for the meter.

Meter Calibration (Continued)



Temperature Correction

If the conditions of testing are such that there will be a change of more than a few degrees in the temperature of the liquids between the time it passes through the meter and the time the prover is read, it will be advisable to make a temperature correction to the prover readings. To do this, it is necessary to install thermowells; to take readings of the temperature of the liquids in the meter and in the prover; and to take the degrees API of the liquid. Corrections can then be easily made by the use of the National Standard API Tables.

Calibration Adjustment

One complete turn of the adjuster barrel is equal to 1 gallon in 100 gallons or 1% of delivered volume. The adjuster body will show divisions of 1%, while the adjuster barrel has divisions of 0.02%.

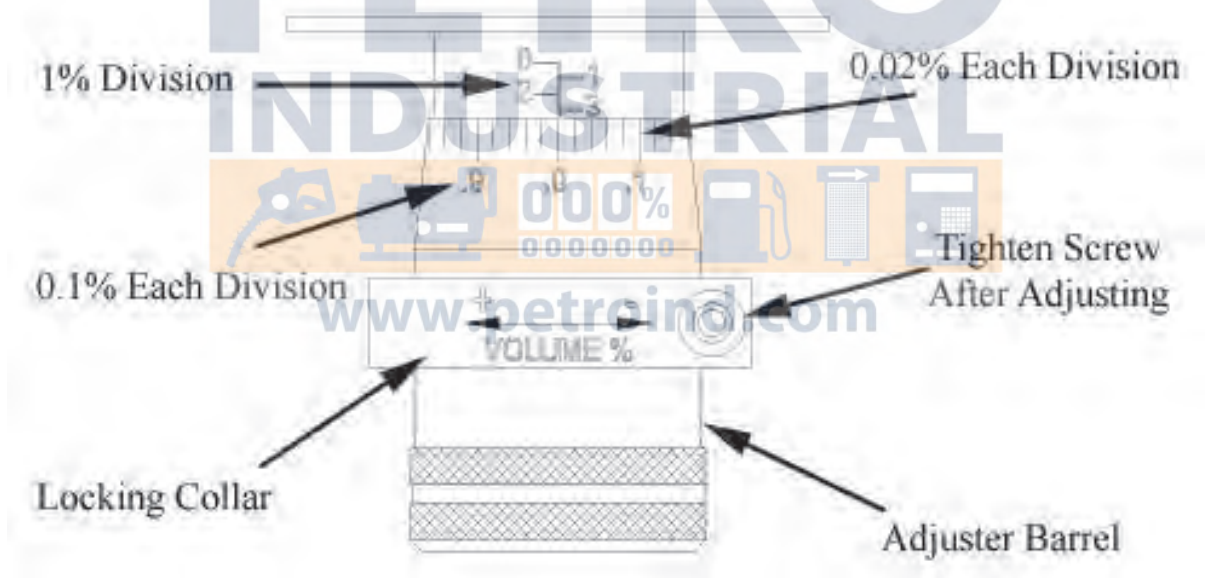

For volumes other than 100 gallons, the following formula may be used to calculate the Adjuster percent to increase or decrease prover volume.

$$\frac{\text{Volume on Prover minus Volume on Meter Counter}}{\text{Volume on Meter Counter}}$$

Split Compartment Test



Purpose: A product depletion test verifies the proper operation of air elimination when the storage tank for the product being measured is pumped dry. This test is necessary for meters that may drain a tank completely, such as a vehicle tank meter.

Multiple-Compartment Test Procedure:

- 1). Begin the test from a compartment (ideally the largest compartment) containing an amount of fuel equal to or less than one-half the nominal capacity of the prover being used. Operate the meter at the normal full flow rate until the compartment is empty. There are several methods for determining that the compartment is empty. There may be a significant change in the sound of the pump. There may be visual evidence that the compartment has run dry. The meter may stop entirely or may begin to move in jumps (pause, resume running, then pause, then run again.)
 - 2). Continue the test until the meter indication stops entirely for at least 10 seconds. If the meter stops for 10 seconds or more, proceed to step 3. If the meter indication fails to stop entirely for a period of 10 seconds, continue to operate the system for 3 minutes.
 - 3). Close the valve from the empty compartment, and if top filling, then close the nozzle or valve at the end of the delivery hose. Open the valve from another compartment containing the same product. Carefully open the valve at the end of the delivery hose. Pockets of vapor or air may cause product to splash out of the prover. The test results may not be valid if product is splashed out of prover. Appropriate attire and protection is required, but caution is still necessary.
 - 4). Continue delivering product at the normal full flow rate until the liquid level in the prover reaches the nominal capacity of the prover.
 - 5). Close the delivery nozzle or valve, stop the meter. Allow any foam to settle, then read the prover sight gauge.
 - 6). Compare the meter indication with the actual delivered volume in the prover.
 - 7). Calculate the meter error, apply Product Depletion test tolerance, and determine whether or not the meter error is acceptable. Reference the NIST Handbook 44 for further information.
-

Split Compartment Test (Continued)



Single Compartment Test Procedure:

The test of single-compartment tanks is easier to accomplish if there is a quick-connect hose coupling between the compartment valve and the pump that supplies product to the meter. If the system does not have quick-connect couplings between the compartment and the meter, an additional source of sufficient product at the test site is required.

Without a quick-connect coupling:

- 1). Begin the tests with the compartment containing an amount of fuel equal to or less than one-half the nominal capacity of the prover being used. Operate the meter at the normal full flow rate until the supply tank is empty. There are several methods for determining that the tank is empty. There may be significant change in the sound of the pump. Someone may visually watch for the tank to run dry. The meter may stop entirely or may begin to move in jumps (pause, resume running, the pause, then run again).
 - 2). Continue the test until the meter indication stop entirely for at east 10 seconds. If the meter stops for at least 10 seconds, proceed to step 3. If the meter indication fails to stop entirely for at least 10 seconds, continue to operate the system for 3 minutes.
 - 3). Close the compartment valve and the delivery nozzle or valve if top filling. Stop the pump and load sufficient product from the alternate source into the supply compartment for the meter being tested. Allow the product to stand in the compartment for a brief time to allow entrained vapor or air to escape.
 - 4). Open the compartment valve and restart the pump without pump resetting the meter to zero. Care fully open the nozzle of valve at the end of the delivery hose. Pockets of vapor or air may cause product to splash out of the prover. The test results may not be valid if product is splashed out of the prover. Appropriate attire and protection is required, but caution is still necessary.
 - 5). Continue delivery of product at the normal full flow rate until the liquid level in the prover reached the nominal capacity of the prover.
 - 6). Close the delivery nozzle or valve, stop the meter, and allow any foam to settle, then read prover sight gauge.
 - 7). Compare the meter indication with the actual delivered volume in the prover.
 - 8). Calculate the meter error, apply Product Depletion test tolerance, and determine whether or not the meter error is acceptable. Reference the NIST Handbook 44 for further information.
-

Split Compartment Test (Continued)



With a quick-connect coupling:

- 1). During a normal full flow test run; close the compartment valve at approximately one-half of the nominal prover capacity. Then slowly and carefully disconnect the quick-connect coupling, allowing the pump to drain the supply line.
- 2). Continue the test until the meter indication stops entirely for at least 10 seconds. If the meter fails to stop entirely for at least 10 seconds, continue to operate the system for 3 minutes.
- 3). If the meter stops for at least 10 second or after 3 minutes, close the delivery nozzle or valve at the end of the delivery hose if top filling.
- 4). Disconnect and reconnect the quick-connect coupling and open the compartment valve.
- 5). Carefully open the nozzle or valve at the end of the delivery hose. Pockets of vapor or air may cause product to splash out of the prover. The test results may not be valid if product is splashed out of the prover. Appropriate attire and protection is required, but caution is still necessary.
- 6). Continue the delivery of product at the normal full flow rate until the liquid level in the prover reaches the prover's nominal capacity.
- 7). Close the delivery nozzle or valve, stop the meter, allow any foam to settle, then read the prover sight gauge.
- 8). Compare the meter indication with the actual delivered volume in the prover.
- 9). Calculate the meter error, apply Product Depletion test tolerance, and determine whether or not the meter error is acceptable.

Tolerance for Vehicle-Tank Meters

Meter size	Maintenance and Acceptance
2" (50 mm)	137 cubic inches
3" (75 mm) and larger	229 cubic inches

The results of the product depletion test may fall outside of the applicable test tolerance as this is a stand-alone test.

The test draft should be equal to at least the amount delivered by the device in 1 minute at its maximum discharge rate, and in no case should it be less than 50 gallons.

Maintenance



!WARNING!

Test equipment should be grounded to prevent a possible spark. Test area should have no ignition source. Operators should wear personal protection and prevent any product exposure and environmental issues.

- 1). Keeping accurate maintenance and calibration records can be an excellent tool in determining the frequency of inspection or maintenance for a system. As the meter wears, the calibration will be affected and require adjustment. A personality profile can be created for each meter to help guide in a maintenance schedule.
- 2). Great care should be utilized in the maintenance of the metering system. Personal safety protection, environmental hazards, and government regulations need to be the foremost priority. Only fully trained personnel should be involved in maintenance. Failure to use original TCS replacement parts will void any Weights & Measures approvals and risk damage to the meter system.
- 3). ALWAYS RELIEVE INTERNAL SYSTEM PRESSURE TO ZERO BEFORE DISASSEMBLY OR INSPECTION.
- 4). SERIOUS INJURY OR DEATH FROM FIRE OR EXPLOSION COULD RESULT FROM MAINTENANCE OF AN IMPROPERLY DEPRESSURIZED AND EVACUATED SYSTEM.
- 5). Total Control Systems flow meters and accessories are often used with petroleum, solvents, chemicals, and other liquids that may be explosive, extremely flammable, very toxic, oxidizing, and corrosive. Severe injury or fatalities may arise if appropriate safety precautions are not followed.
- 6). Before replacing or cleaning filter/strainer screen, the electrical system must be turned off. Product needs to be drained from system. Collect all product and return to storage or dispose of properly. Replace all drain plugs that were removed. Personal safety protection must be worn at this time. Make sure there is adequate ventilation in the area. The metering system will not completely drain so make sure you collect extra product when you remove the strainer cover. Clean the screen once a week, or more often if there is a lot of sediment in the system. Make sure there is no ignition source and the system is grounded. Replace all plugs that were removed for drainage.
- 7). The metering system is heavy and awkward so take precaution to handle it properly.
- 8). Do not use force to disassemble or use a screwdriver to pry open any part of the metering system. Have the proper tools available before trying to repair the meter system. Be careful of the parts as they can be sharp and heavy. Do not drop housing or rotors as they can cause injury and can destroy the parts. Be careful when inspecting and turning the timing gears and rotors as they can pinch fingers, turn slowly to verify smooth operation.
- 9). When inspecting the spring loaded preset valves do not place anything inside the housing, as the action of the valve will pinch this object when the valve closes.

Maintenance (CONTINUED)



!WARNING!

Test equipment should be grounded to prevent a possible spark. Test area should have no ignition source. Operators should wear personal protection and prevent any product exposure and environmental issues.

- 10). When removing gaskets or o-rings, carefully check for damage or corrosion. Any cracked, rough, worn, elongated or swollen o-rings need to be replaced. When replacing the o-rings, place grease along the inside of the o-ring groove or completely around the o-ring to help the o-ring stay in the o-ring groove during assembly. If o-ring is pinched or not in the o-ring groove, the meter system will leak and cause serious problems to the environment and equipment. Collect all replaced parts and dispose of properly. Do not weld any part of the meter system or accessories as this will weaken the part and allow for leaks
- 11). All bolts and screws need to be coated with anti-seize. Then follow the torque specifications for each flow meter.
- 12). Recommended levels of maintenance and inspection will depend upon the system variables, such as the products being measured, their corrosiveness, system pressure requirements, government or company regulations, and age of metering system. If hydrostatic testing is required, the system pressure should not exceed 1.5 times the marked meter pressure. It is not recommended to pneumatically test the meter system at anytime.
- 13). If any component of the meter system is removed from the system, it should be thoroughly flushed with a compatible liquid. After this is done, immediately refill the meter or accessory with a compatible liquid to prevent corrosion and water build up.

Storage Instructions



Short periods of non-use of the meter (a week or less) should present no problem, provided that the meter remains full of product. For long periods of non-use, such as winter storage, the following procedure is recommended. Before long-term storage, a good practice is calibration of the meter to determine that it is functioning properly.

- 1). To store the meter when it is left in line, flush the system with clean water until 70-80 gallons of water have gone through the meter.
- 2) Pump a 50% anti-freeze / 50% water solution through the entire system (100% RV antifreeze may be used instead). With the pump running, shut off a valve downstream from the meter, making sure that anti-freeze solution is present at that point. Then close an upstream valve, such that the meter remains full of anti-freeze solution.
- 3) Remove the register from the meter, and lubricate the drive coupling shaft. After lubrication, reassemble the register onto the meter.

When starting the system after a period of storage, check the meter's calibration as detailed earlier in the service manual.

700-15 Dimensions

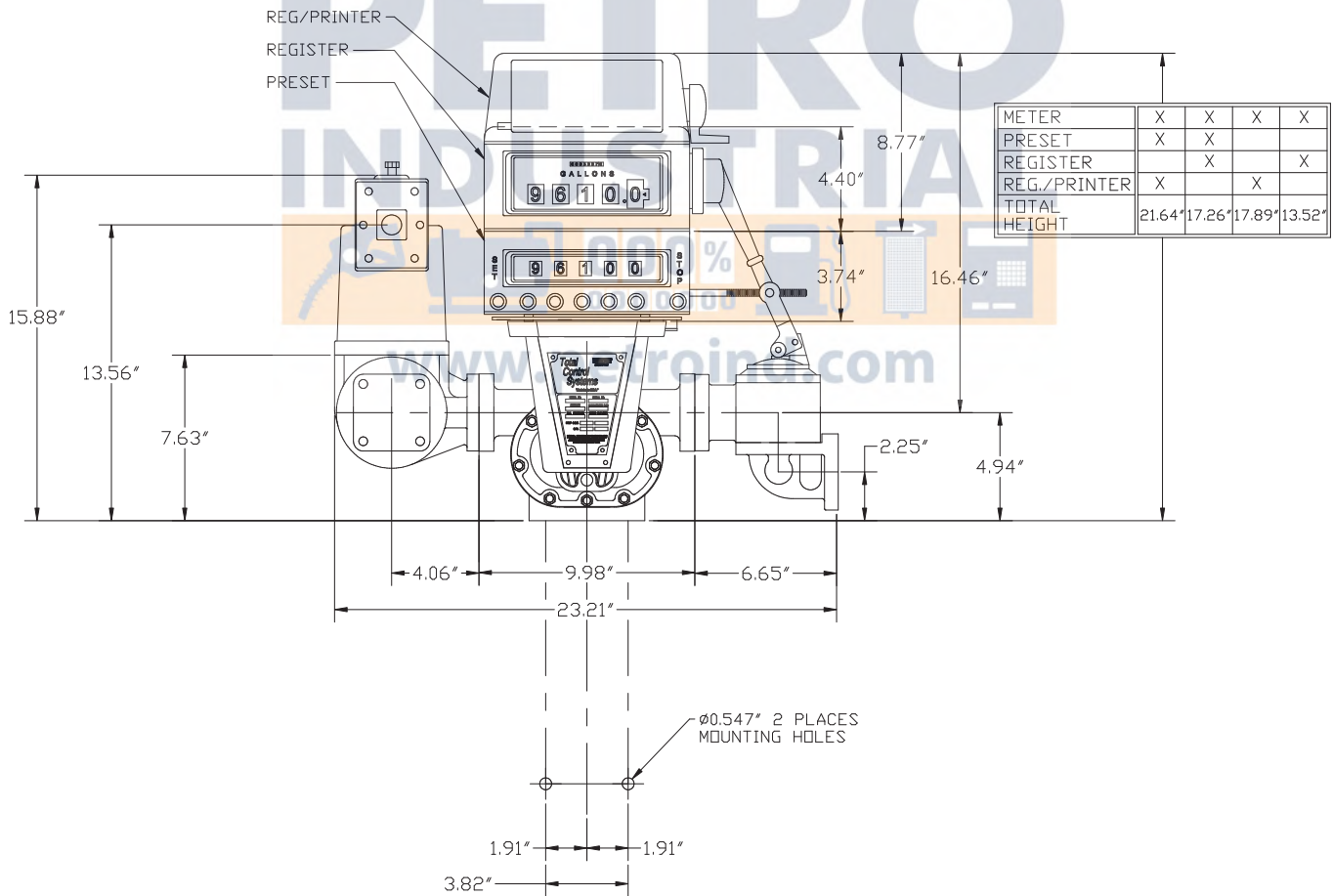
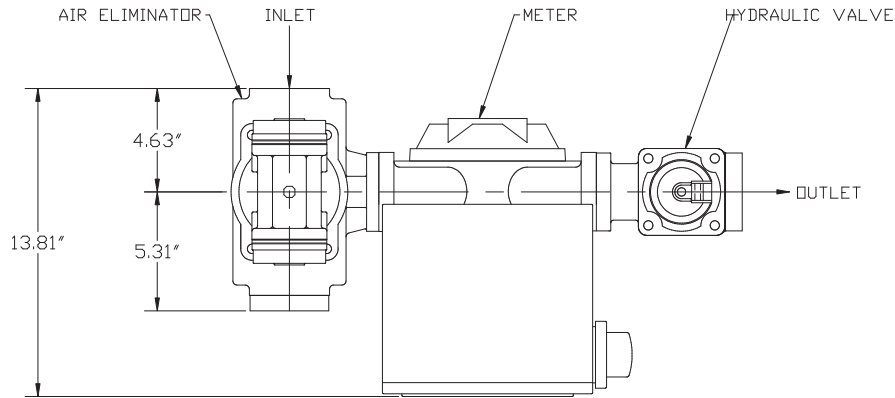

All measurements are in inches.

700-15 Meter Assembly

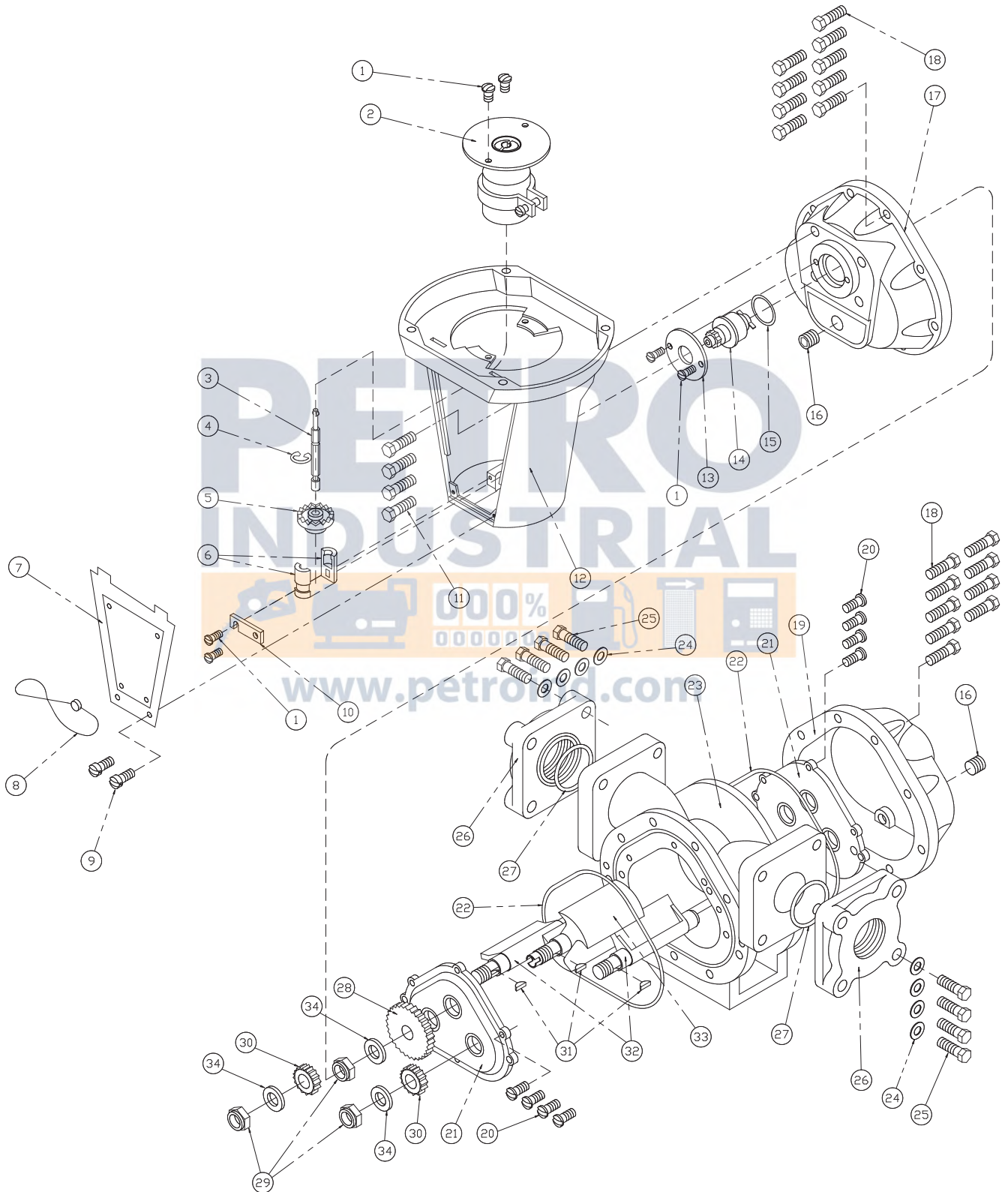

700-15 Meter Assembly

Item	Description	Qty	700-15			
			SP	SPA	IP	IC
1	Round Head Screw	6	1-128279	1-128279	1-128279	1-128279
2	Adjuster Assembly	1	700100	700100	700100	700100
3	Drive Shaft	1	700019	700019	700019	700019
4	E-Ring	1	700016	700016	700016	700016
5A	Acetal Face Gear, STD	1	700037	700037	700037	700037
5B	Brass Face Gear, High Temp.	1	700041	700041	700041	700041
6A	Acetal Bushing, STD	2	700020	700020	700020	700020
6B	Brass Bushing, High Temp.	2	700055	700055	700055	700055
7	Adjuster Cover Plate	1	700017	700017	700017	700017
8	Seal Wire	1	1-118849	1-118849	1-118849	1-118849
9	Drilled Head Screw	2	700042	700042	700042	700042
10	Drive Shaft Retainer	1	700022	700022	700022	700022
11	Head Mount Screw	4	700040	700040	700040	700040
12	Register Support	1	700200	700200	700200	700200
13	Packing Retaining Plate	1	700015	700015	700015	700015
14	4:1 Packing Capsule Assy.	1	700160	700160	700165	700165
15	Packing O-ring	1	700009	700009	700010	700010
16	Plug	2	700024	700024	700024	700024
17	Front Cover	1	701500	701500	701500	701500
18	Cap Screw	18	700026	700026	702016	702016
19	Rear Cover	1	701550	701550	701550	701550
20	Round Head Screw	8	702014	702014	702014	702014
21	Bearing Plate	2	701230	701225	701205	701225
22	Cover O-ring	2	701001	701001	701002	701002
23	Housing	1	701110	701110	701110	701110
24	Flat Washer	8	702018	702018	702018	702018
25	Cap Screw	8	702017	702017	702017	702017
26	Flange	2	701600K	701600K	701600K	701600K
27	Flange O-ring	2	702012	702012	702013	702013
28	Blocking Rotor Gear	1	701351	701351	701351	701351
29	Rotor Lock Nut	3	701010	701010	701010	701010
30	Displacement Rotor Gear	2	701451	701451	701451	701451
31	Rotor Key	3	701008	701008	701008	701008
32	Displacement Rotor	2	701405	701405	701410	701410
33	Blocking Rotor	1	701305	701305	701310	701310
34	Gear Spacer	3	701355	701355	701355	701355

740 Air Eliminator / Strainer Assembly

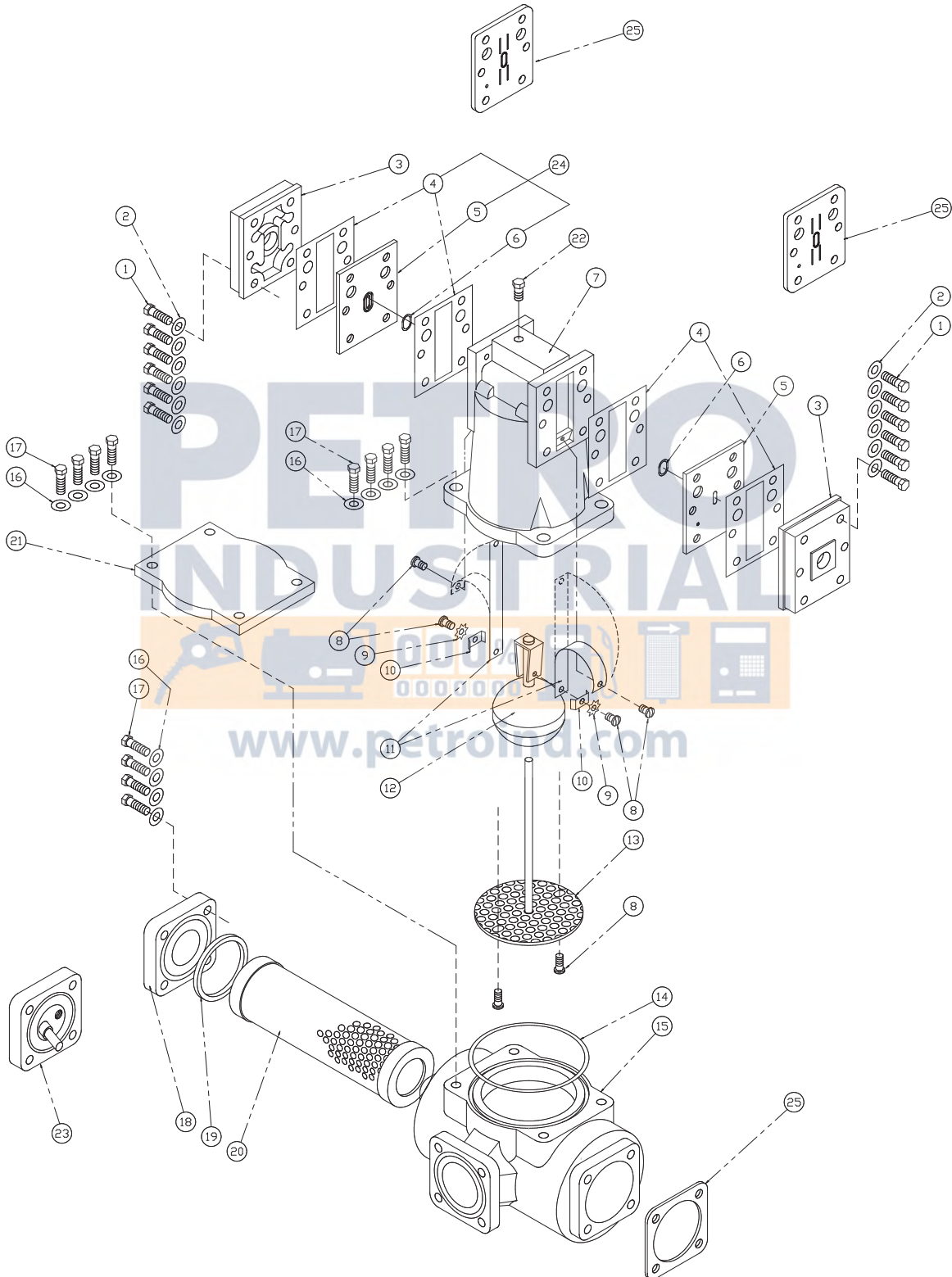

740 Air Eliminator / Strainer Assembly

Item	Description	Qty	740-20SP	740-20IP
1	Cap Screw	12	740050	740050
2	Ring Washer	12	740051	740051
3	Outlet Cover	2	740010	740010
4	Plate Seal	4	740005	740004
5	Valve Plate	2	740038	740006
6	O-ring	2	740036	740037
7	Air Eliminator Housing	1	740020	740020
8	Screw	6	740030	740030
9	Split Lock Washer	2	740017	740017
10	Retaining Clip	2	740012	740012
11	Reed Valve	2	740007	740007
12	Float Assembly	1	740013	740013
13	Diffuser and Shaft Assembly	1	740035	740035
14	Top Seal O-ring	1	740009	740019
15	Strainer Housing	1	742021	742021
16	Flat Washer	8	702018	702018
17	Cap Screw	8	700054	700054
18	Basket Cover	1	742050	742050
19	Seal Ring	1	742003	742004
20A	0.050P Strainer Basket, STD	1	-	742005
20B	40M Strainer Basket, STD	1	742010	-
20C	80M Strainer Basket	1	742015	-
20D	100M Strainer Basket	1	742025	-
21	Strainer Cover, Opt.	1	740041	740041
22	Plug	1	2-126146	2-126146
23	Basket Cover and Thermowell, Opt.	1	742055	742055
24	Valve Plate Kit	1	740138	740106
25	Encapsulated Valve Plate	2	740205	740215
26	Flange Gasket	1	702022	702023

750-20 Hydraulic Preset Valve Assembly

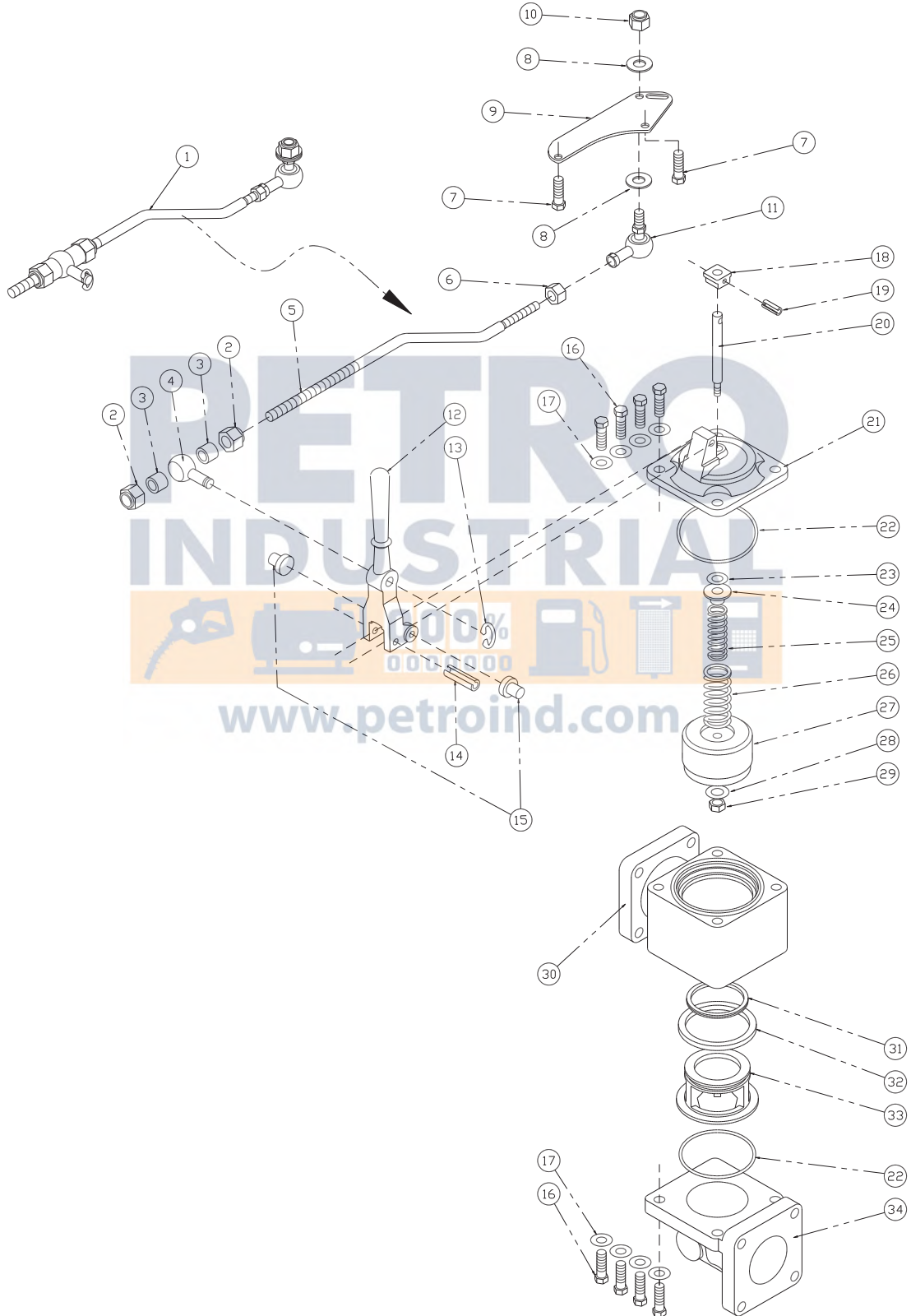

750-20 Hydraulic Preset Valve Assembly

Item	Description	Qty	750-20	
			SP	IP
1	Linkage Assembly Kit	1	751002KT	751002KT
2	Linkage Lock Nut	2	750001	750001
3	Linkage Sleeve	2	750002	750002
4	Linkage Spherical Pivot	1	750003	750003
5	Linkage Arm	1	751002	751002
6	Hex Nut	1	750010	750010
7	Linkage Screw	2	750011	750011
8	Flat Washer	2	68001	68001
9	Preset Bracket	1	752099	752099
10	Locking Nut	1	750012	750012
11	Ball & Stud	1	753053	753053
12	Operating Lever	1	752010	752010
13	Linkage E-Ring	1	750004	750004
14	Roll Pin	1	752004	752004
15	Step Pin	2	752005	752005
16	Screw	8	700054	700054
17	Flat Washer	8	702018	702018
18	Bushing	1	752006	752006
19	Roll Pin	1	752007	752007
20	Valve Shaft	1	752008	752008
21	Valve Cap	1	752015	752015
22	Body O-ring	2	752044	752045
23	O-ring	1	752011	752012
24	O-ring Retainer	1	752013	752013
25	Internal Spring	1	752019	752019
26	External Spring	1	752014	752014
27	Piston	1	752020	752020
28	Washer	1	752023	752023
29	Lock Nut	1	752024	752024
30	Valve Body	1	752040	752040
31	Upper Seal	1	752035	752036
32	Lower Seal	1	752033	752034
33	Piston Guide	1	752030	752031
34	Elbow	1	752041	752041

700CV15SP / 700CV15SS Back Pressure Check Valve Assembly

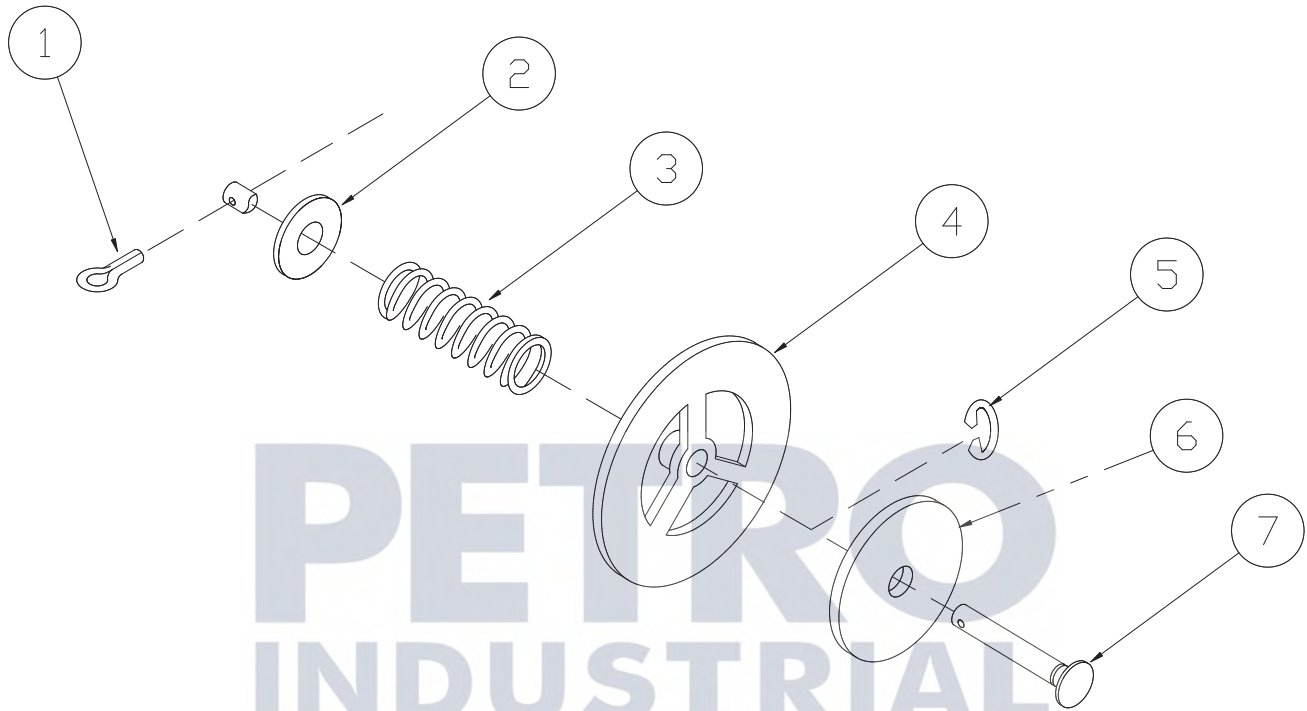

Item	Description	Quantity	700CV15 (Plated Steel)	700CV15SS (Stainless Steel)
1	Cotter Pin	1	70003	70050
2	Flat Washer	1	70070	70075
3	Compression Spring	1	70002	70055
4	Valve Plate Assembly	1	70026	70041
5	Retaining Ring	1	6-052482	70045
6	Valve Disc	1	70031	70038
7	Poppet Post	1	70033	70040

Torque Specifications

700-15 METER ASSEMBLY

Part Number & Description	Tool	Bolt/Nut Size	Foot Lbs.		Newton Meter	
			Unlubricated	Lubricated	Unlubricated	Lubricated
TCS 700026 Cover	1/2" hex wrench/socket	5/16-18 UNC 2B	11	6.6	14.9	8.9
TCS 700040 Counter Support	7/16" hex wrench/socket	1/4-20 UNC 2B	6.3	3.8	8.5	5.2
TCS 702014 Bearing Plate	slotted screwdriver	10-24 UNC 2B	1.9	1.1	2.6	1.5
TCS 1-128279 Dust Cover	slotted screwdriver	10-24 UNC-2B	1.9	1.1	2.6	1.5
TCS 701010 Rotor Gear	3/4" hex wrench/socket	1/2-20	45.1	27.1	61.1	36.7

740-20 AIR ELIMINATOR/STRAINER ASSEMBLY

Part Number & Description	Tool	Bolt/Nut Size	Foot Lbs.		Newton Meter	
			Unlubricated	Lubricated	Unlubricated	Lubricated
TCS 740050 Cover Plate	1/2" hex wrench/socket	5/16-18 UNC 2B	11	6.6	14.9	8.9
TCS 701017 Cap Screws	9/16" hex wrench/socket	3/8-16 UNC 2B	19.7	11.8	26.7	16.0
TCS 740030 Reed & Diffuser	slotted screwdriver	8-32 UNC 2B	1.65	1.0	2.2	1.4

750-20 HYDRAULIC PRESET VALVE ASSEMBLY

Part Number & Description	Tool	Bolt/Nut Size	Foot Lbs.		Newton Meter	
			Unlubricated	Lubricated	Unlubricated	Lubricated
TCS 701017 Cover & Elbow	9/16" hex wrench/socket	3/8-16 UNC 2B	19.7	11.8	26.7	16.0
TCS 752024 Piston Lock Nut	7/16" hex Wrench/socket	1/4-20 UNF 3B	6.3	3.8	8.5	5.2

This Torque Chart is for 18-8 Stainless Steel Bolts

Values can be +/- 10% of value listed

Drive Components



Removing the Dust Cover

- 1) Cut dust cover seal. Remove the dust cover screws with a standard flathead screwdriver.
- 2) Note the setting on micrometer.
- 3) Note the position of the drive gear (either above or below the packing gland pinion).



Removing the Adjuster

- 1) Loosen the retaining screws using a standard flathead screwdriver.
- 2) Slide the retaining clip up and over to the left side.



- 3) From the top, remove the screws to adjustor plate.
- 4) Lift adjustor out of the counter adapter.
- 5) Remove the adjustor drive assembly.

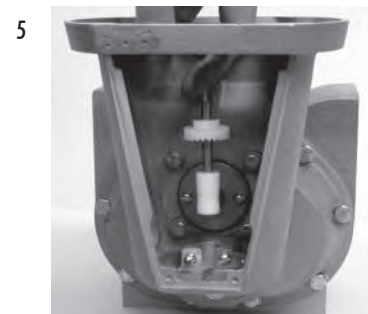
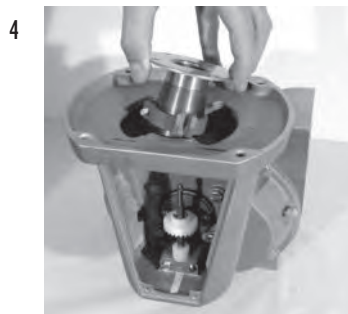

Disassembly of Meter (Continued)



!WARNING!

All internal pressure must be relieved to ZERO (0) pressure before beginning disassembly of meter or components

Draining Meter & Removing Counter Support

- 1) Drain the meter by turning it on either the inlet or outlet side.
- 2) Remove the counter bracket screws with a hex wrench or socket driver.
- 3) Remove the drain plugs on the front and rear covers using an allen wrench. Allow more fluid to drain from the meter.

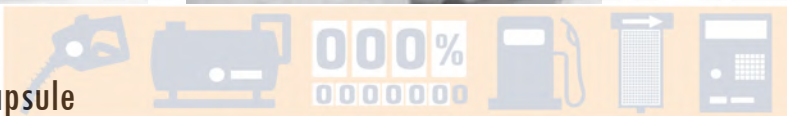

Removing Packing Capsule

- 1) Remove the retaining plate using a standard flathead screwdriver.
- 2) Pull out the packing gland from the meter.

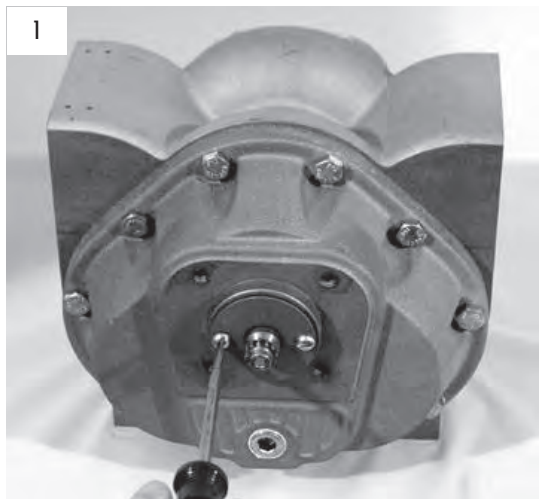

Disassembly of Meter (Continued)



Front & Rear Cover

- 1) Remove the screws on the front cover using a socket or box wrench.
- 2) Remove front cover.
- 3) Remove the screws on the back and remove rear cover.
- 4) Remove the O-ring from both sides of the housing

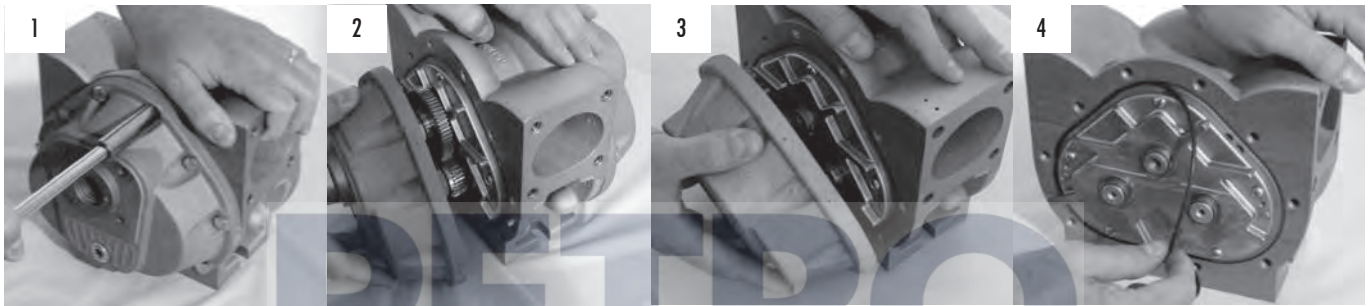

Rotor Gears

- 1) Using a spare displacement rotor gear, place it between the rotor and blocking gear on the meter.
- 2) Use the socket or box wrench to loosen the right rotor gear lock nut. Repeat for the left rotor gear lock nut.
- 3) Move the spare displacement rotor gear to the other side and loosen the blocking rotor lock nut.



Special Notes

- 1) DO NOT remove rotor gears using a screwdriver! This could damage the rotor gear and create potential wear problems within the measuring chamber.
- 2) If a spare rotor gear is not available, then use shop rag between gear teeth.

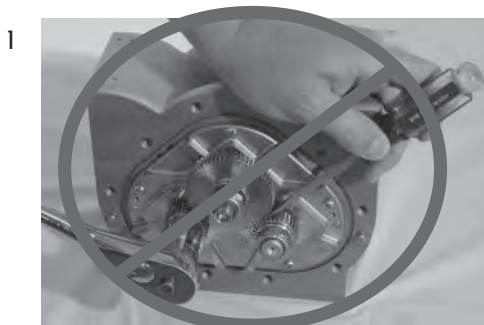

Disassembly of Meter (Continued)



Removing Bearing Plate

- 1) Remove the bearing plate retaining screws with a standard flathead screwdriver.
- 2) To remove bearing plate & rotors, insert a screwdriver into the notches near the dowel pins.
- 3) Gently pry the bearing plate off the dowel pins and slide out the bearing plate and rotors from the housing.

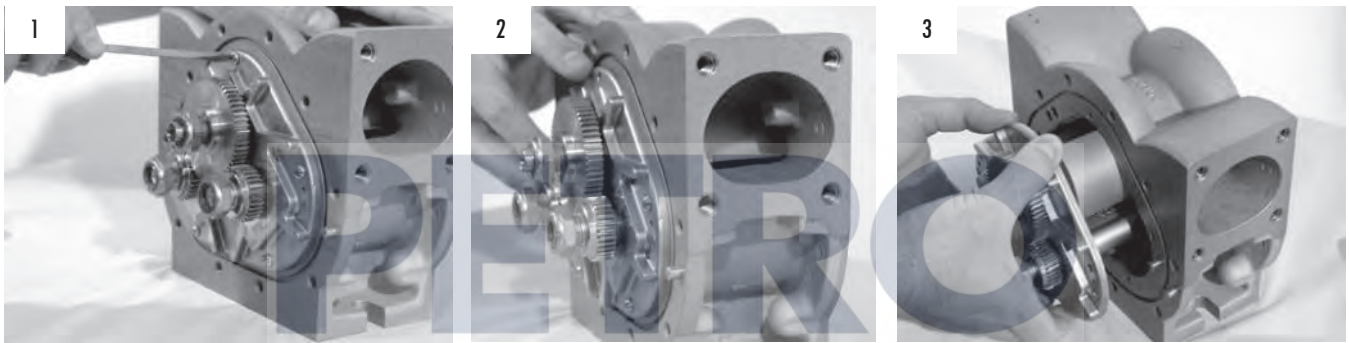

INDUSTRIAL

Removing Lock Nuts & Rotors



- 4) Remove rotor lock nuts from each gear.
- 5) Pull gears off of rotor shaft.
- 6) Remove rotor key using pliers (this might not be necessary as rotor may slide right out of bearing plate).
- 7) Remove rotors from bearing plate.

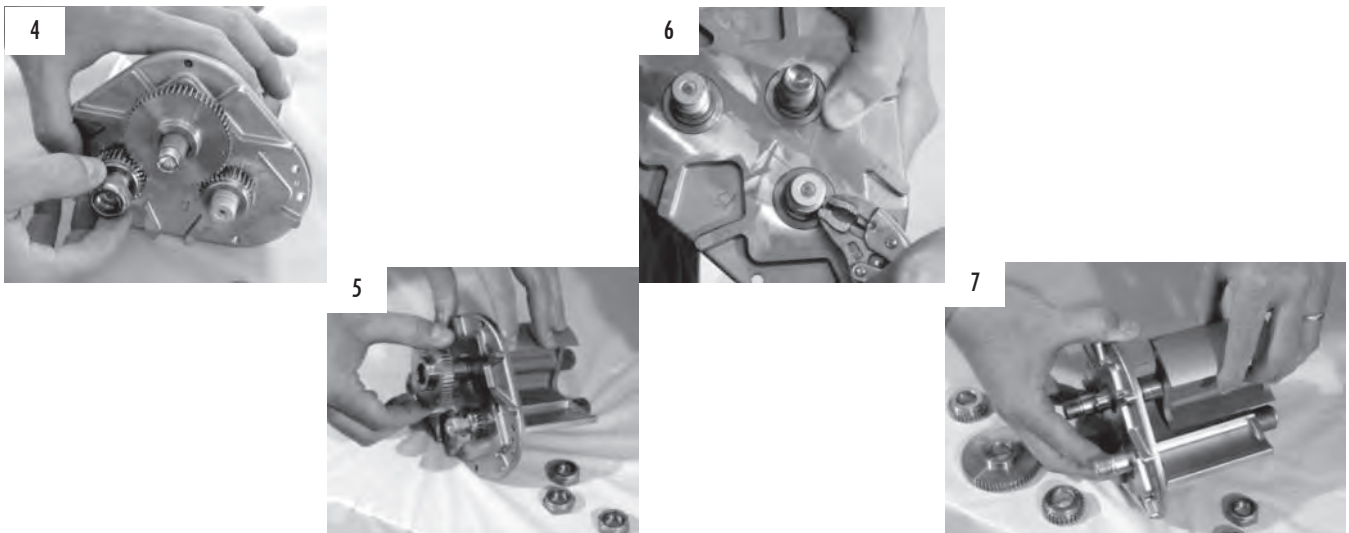

Inspection of Parts

- 1) Inspect the surfaces of rotors, bearing plates, meter housing and gear teeth for any damage or wear.
- 2) Replace parts as needed.

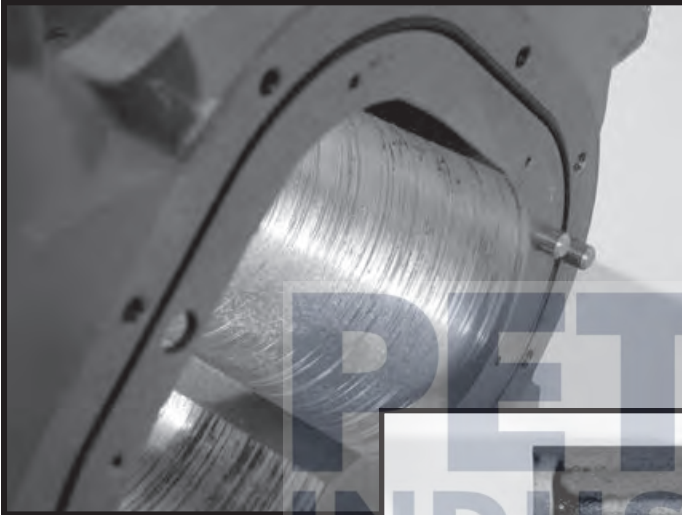

CHAMBER WEAR

- A) Foreign debris, similar to sand or sludge, has run through the meter.
- B) Meter has been operated at a higher capacity and has worn the bearings out, allowing rotors to drop into the chamber.



GEAR WEAR

- A) Meter has been run on air.
- B) Meter has been operated at a higher volume capacity than what is rated.

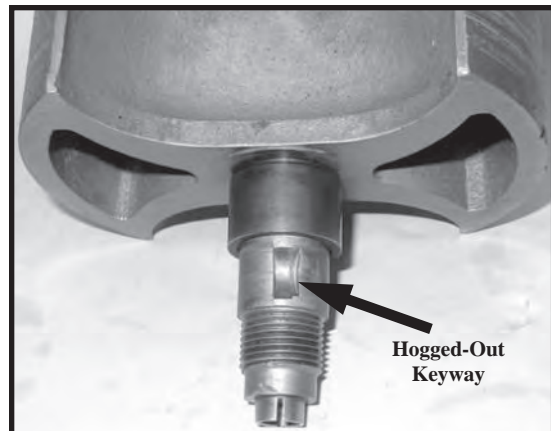
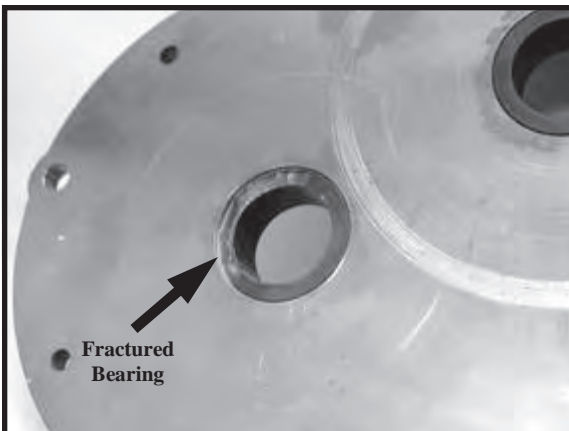

HYDRAULIC SHOCK

- A) A valve downstream of the flow meter has abruptly shut off, creating hydraulic shock.
- B) Flow meter potentially had large volume of free air flowing within the system, followed by fluid.

Reassembly of Meter

Reinstalling Rotors

- 1) Install rear bearing plate on meter.
- 2) Insert threaded end of blocking rotor and the right displacement rotor into front gear plate (reinsert rotor keys if necessary).
- 3) Align the two rotors (see picture 3) before applying gears.



Rotor Gear Timing

- 1) Slide on blocking rotor gear and position the 'arrow' that it is pointing toward the right displacement gear.
- 2) Align 'arrow' on displacement gear with the 'arrow' on the blocking gear and slide on right displacement gear.
- 3) Rotate the blocking rotor gear toward the left displacement gear and again align 'arrows' and slide on left displacement gear.
- 4) Gears and rotors should rotate freely if gears have been installed properly. If so, proceed with starting on the lock nuts until finger tight.

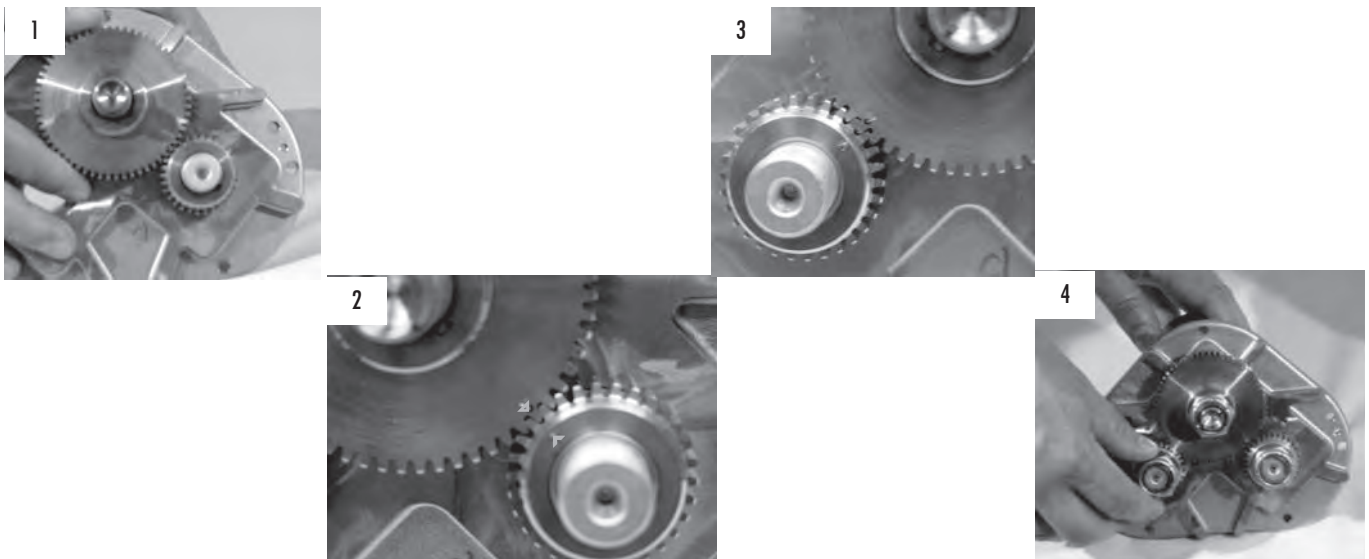

Reassembly of Meter

Reinstalling Bearing Plate

- 1) Align rotors on bearing plate (see picture) before inserting into meter.
- 2) Slide front bearing plate with rotors into meter housing and rear bearing plate.
- 3) Again, rotate gears to make sure they turn freely within the housing before proceeding.

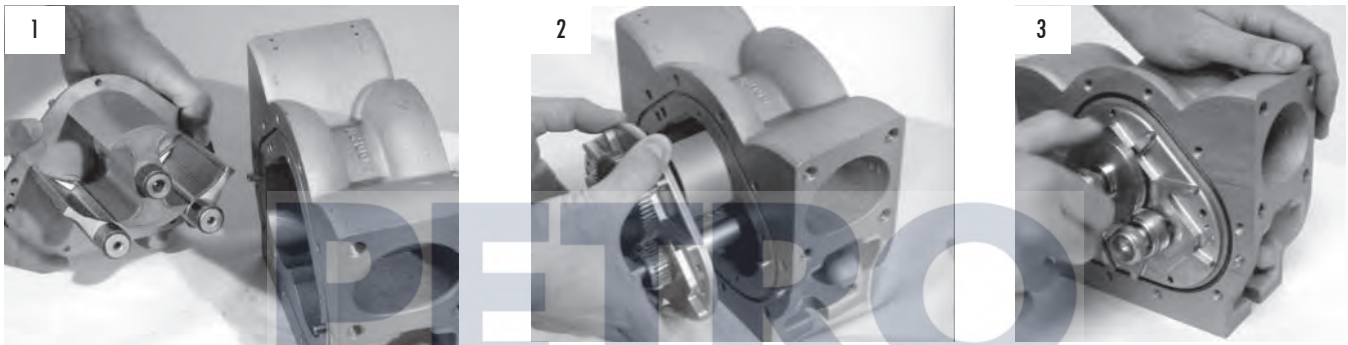

Reinstalling Rotor Gears & Lock Nuts

- 1) Using the spare displacement gear (or shop rag), position between right displacement gear and blocking rotor gear.
- 2) Using the torque specifications, apply and tighten the lock nut on the right and left displacement gears.
- 3) Move the spare gear between the left displacement and blocking rotor gears and then tighten the lock nut on the blocking rotor gear.

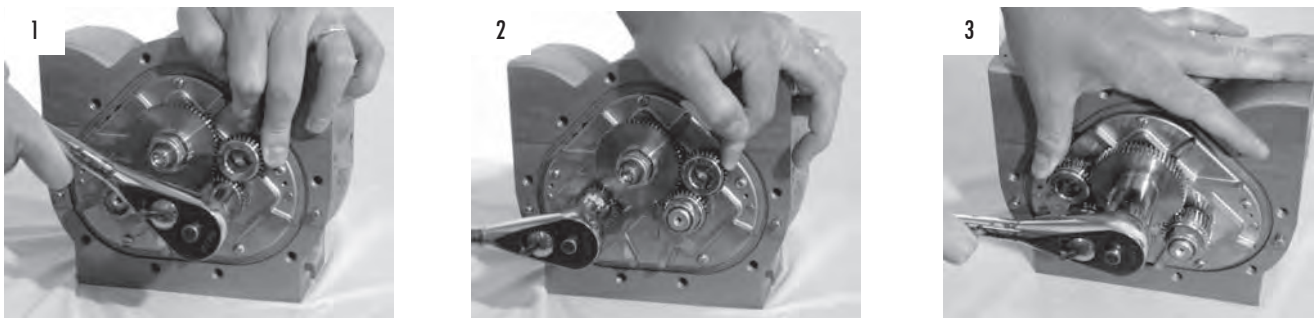

Reassembly of Meter

Reinstalling Packing Capsule & Front/Rear Covers

- 1) Reinstall cover O-rings on the front and rear of meter housing.
- 2) Reinsert packing capsule into front cover of meter with retaining plate and tighten screws.
- 3) When attaching front cover, align packing capsule blade with the slot on the blocking rotor sleeve. Tighten all front cover screws.
- 4) Attach rear cover and tighten all screws.



Reinstalling Counter Support & Adjustor Drive Shaft

- 1) Position the counter support on the front side of meter and tighten all screws.
- 2) Reinsert adjustor drive shaft into the support housing and assure that adjustor face gear teeth meshes with the packing capsule gear.
- 3) Slide down the adjustor mounting bracket and tighten the screws.

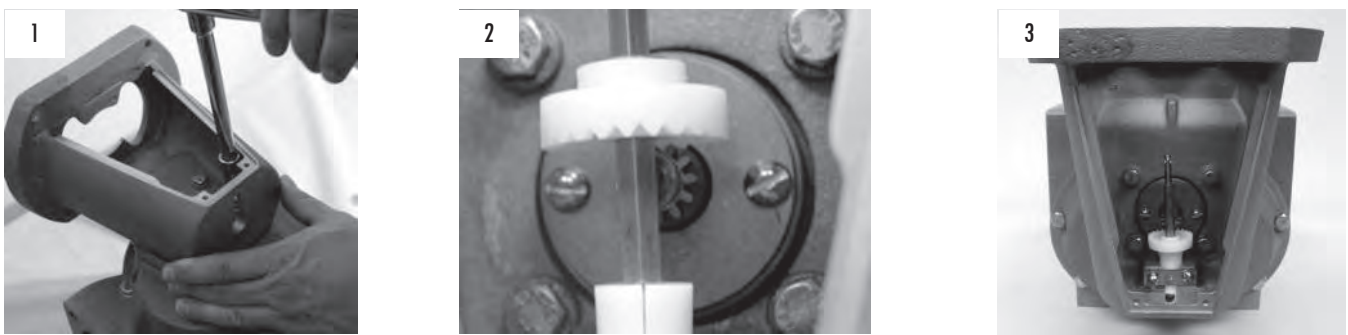

Reassembly of Meter (Continued)

Reinstalling Adjustor

- 1) Reinsert the adjustor into the top of the counter support and assuring that it mates with the drive shaft.
- 2) Tighten the screws that secure the adjustor plate to the counter support.

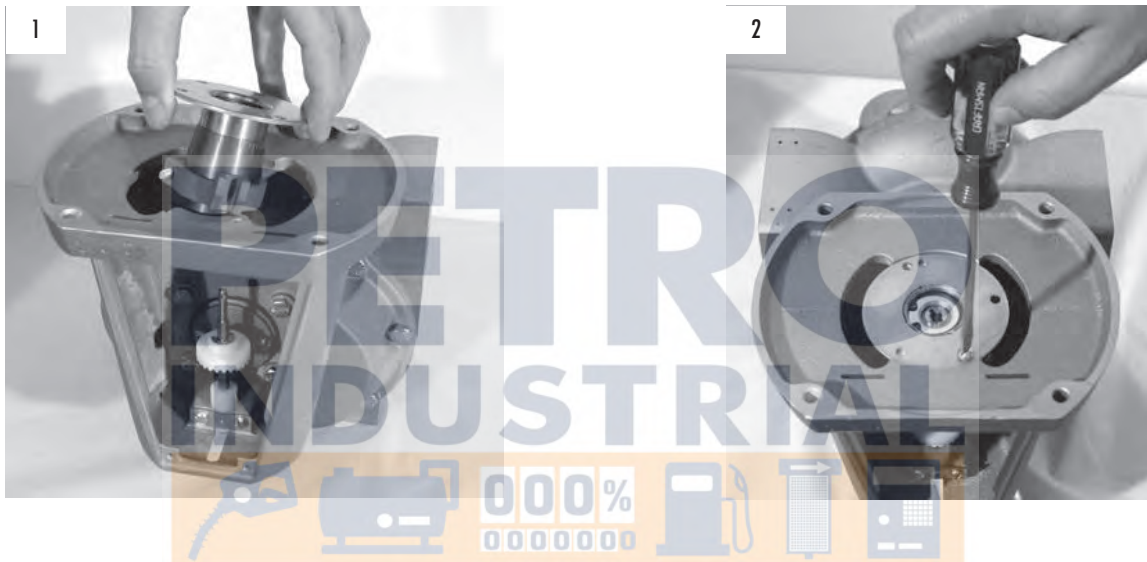

Reinstalling Dust Cover

www.petroind.com

- 1) Reattach dust cover and tighten the screws.
- 2) Back where we started.

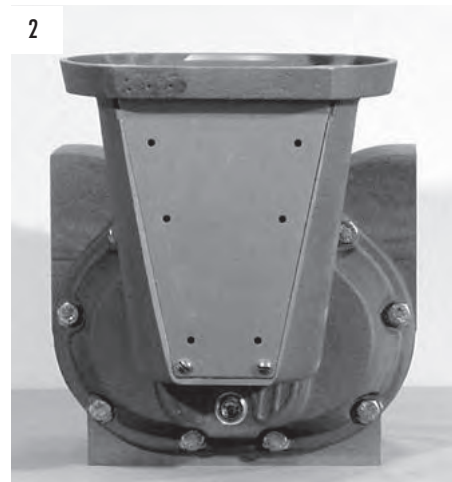
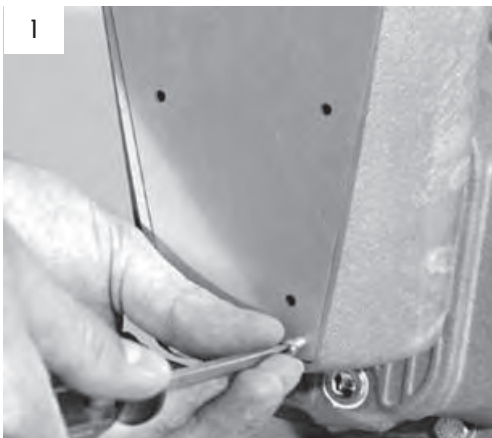

Disassembly of 720 Strainer Assembly



!WARNING!

All internal pressure must be relieved to ZERO (0) pressure before beginning disassembly of meter or components

- 1) Using a hex or socket wrench, remove the four screws and washers from the cover plate.
- 2) Remove the cover plate and o-ring from the housing.
- 3) Remove the strainer screen.
- 4) Check inside housing for any debris and remove using a clean cloth.
- 5) Clean strainer screen by rinsing with a liquid cleaning agent compatible to your product application. A brush may be used to remove imbedded particles. If screen is too dirty to clean, then replace the screen.
- 6) Wipe clean the face of the cover plate and seal ring. Check o-rings for damage and replace as needed.



Reassembly of 720 Strainer Assembly

- 1) Replace the strainer screen into the housing.
- 2) Place the end cover o-ring in the groove of the end cover.
- 3) Put the end cover with o-ring installed on the strainer housing. Replace and fasten end cover with the 4 screws and washers. Tighten the screws according to the torque chart.

Disassembly of 730 Air Eliminator Assembly



!WARNING!

All internal pressure must be relieved to ZERO (0) pressure before beginning disassembly of meter or components

- 1) Using a 1/2" wrench or socket, remove the cover screws from air eliminator cover plate.
- 2) Remove cover plate.
- 3) Remove valve plate, inspect and replace as needed.



- 1) To remove the air eliminator assembly, remove the four screws and washers attaching it to the strainer assembly.
- 2) Using a flathead screwdriver, remove the screws attaching reed valves to air eliminator housing.
- 3) Remove the two screws on the diffuser screen.
- 4) Slide out diffuser shaft assembly.
- 5) Remove the two screws attaching reed valve to the float assembly. Inspect and replace reed valves as needed.

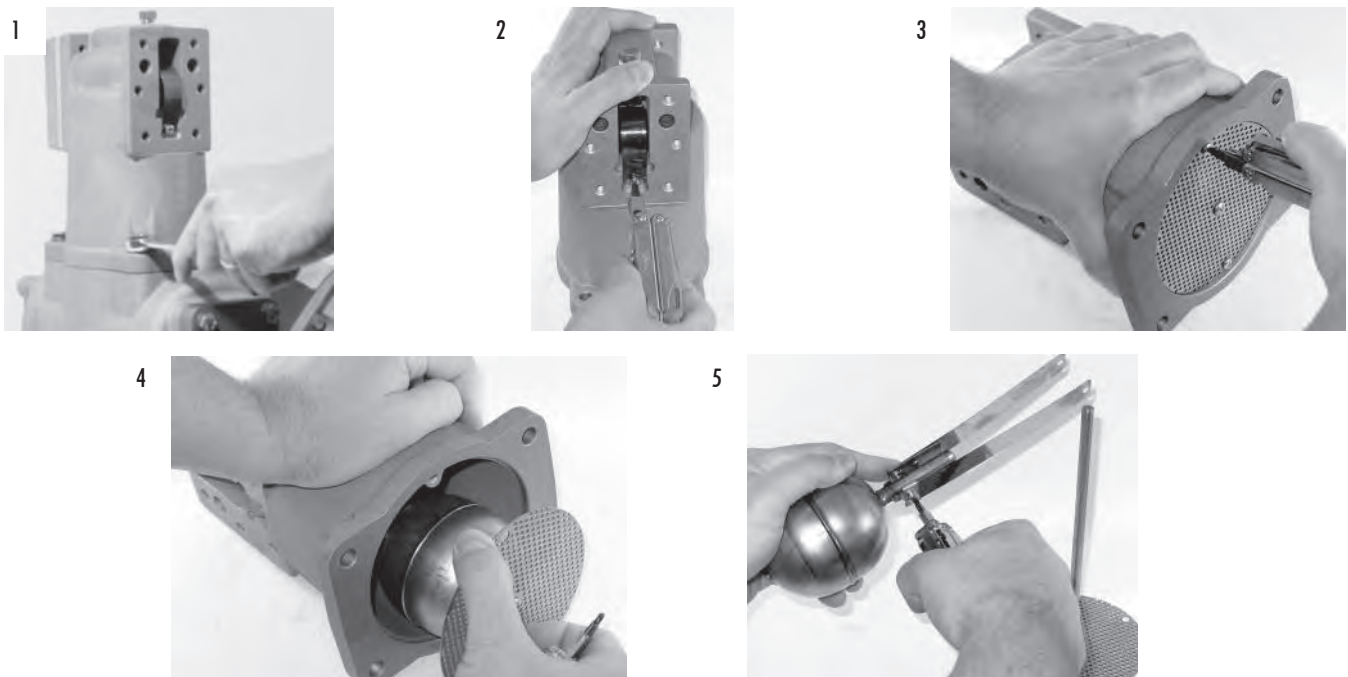

Disassembly of 750-20 Hydraulic Valve



!WARNING!

All internal pressure must be relieved to ZERO (0) pressure before beginning disassembly of meter or components

- 1) Drain all fluid from metering system prior to valve removal.
- 2) Using a 9/16" hex or socket wrench, remove the four screws connecting the valve to the meter. Remove valve from meter and piping.
- 3) Place valve on flat surface and remove the four screws on the valve cover.
- 4) Pull the handle and spring assembly out of the valve housing.

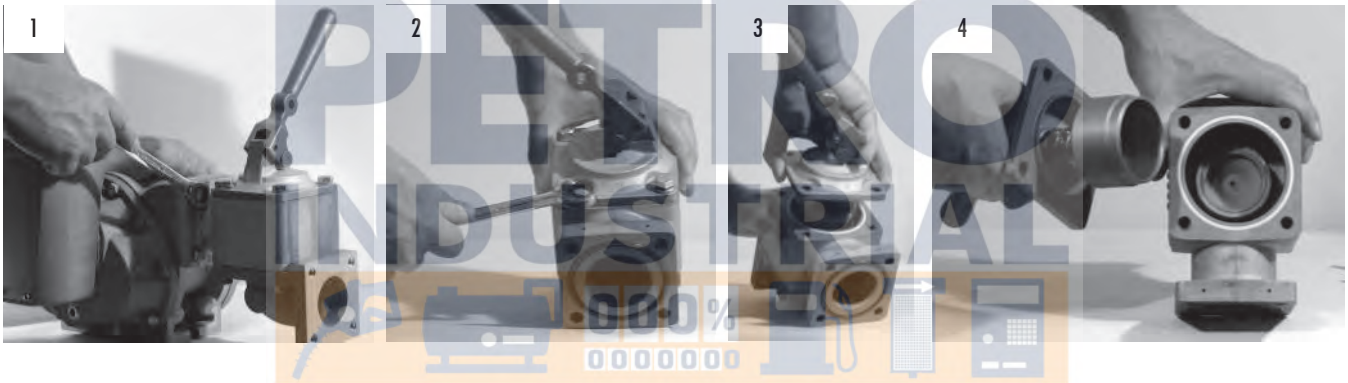

- 5) Using a socket wrench, remove the nut and washer from the valve shaft of piston assembly.
- 6) Remove piston housing.
- 7) Remove external piston spring and then the internal piston spring..
- 8) Inspect piston springs and seals, clean and replace as needed.

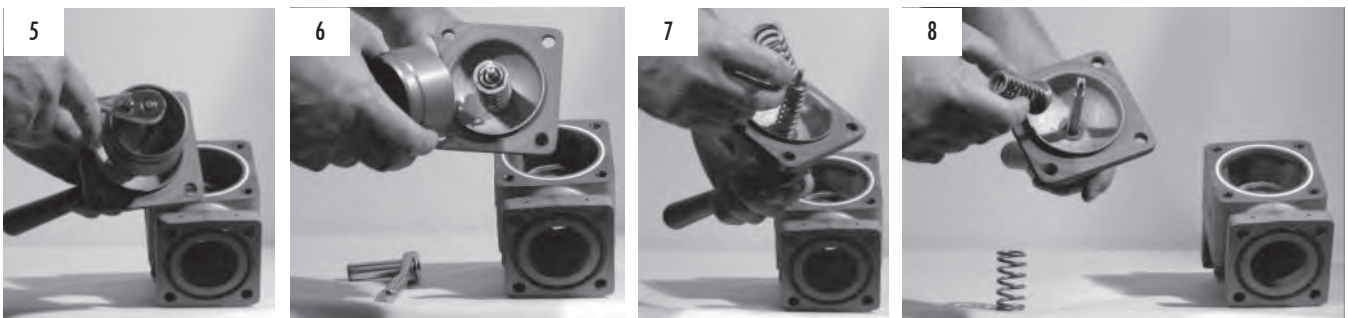

Disassembly of 750-20 Hydraulic Valve



- 1) Using a 9/16" hex or socket wrench, remove the screws attaching the elbow to the valve body.
- 2) Remove the piston guide from the valve body.
- 3) Remove and inspect the upper and lower seals and replace as needed.
- 4) Using a flathead screwdriver, gently remove the valve body o-ring, inspect and replace if needed.



Reassembly of 750-20 Valve

- 1) After seals have been cleaned or replaced, reinsert lower, upper and valve body seals into place.
- 2) Place the piston guide back into valve body.
- 3) Place the internal and external springs into the valve housing and reattach valve elbow to body.
- 4) Insert the piston guide assembly into valve housing.
- 5) Replace internal and external springs onto valve shaft and reattach the piston assembly with nut and washer.
- 6) Reinsert valve cover and piston assembly into valve body and press down to compress the springs.
- 7) While keeping pressure on the valve assembly, insert the four screws and washers into valve cover and tighten down.

Meter Trouble Shooting



PROBLEM: Leaking packing gland and/or housing

Two common causes of packing gland leakage are thermal expansion and hydraulic shock. If two valves in a piping system (on either side of the meter) are closed at one time, and if the temperature rises as little as 1°F in the system, it could result in a rise in pressure within the system that would exceed the working pressure rating of the meter. To avoid this hazard caused by thermal expansion, a pressure-relief valve of some kind must be installed in the system.

Hydraulic shock occurs when a large volume (mass) of liquid is moving through a pipe line at some flow rate and a valve is suddenly closed. When the flow is so stopped, the entire mass of the liquid in the piping system acts as a battering ram, causing a shock effect within the meter. The greater the mass, length of line and/or velocity, the greater the hydraulic shock. Since the valve is usually located at the meter outlet, the meter housing, packing gland and the meter internal members receive the full impact of such hydraulic shock. To prevent this hazard a slow closing two-stage valve should be used with the meter. On those systems where mass, length of line, etc. are of such magnitude as to preclude the elimination of hydraulic shock with the use of a two-stage slow closing valve an impact-absorbing air cushioning device should be used.

O-Ring has been damaged or cover bolts have not been tightened enough.

PROBLEM: Product flows through meter but register does not operate.

- A) Gear train motion interrupted by non-functioning gear due to broken pin or key. Replace pin or key where required.
- B) If all meter parts are moving then problem is in register.
- C) Remove register from meter. If all meter parts are moving but output shaft of adjuster assembly is not, adjuster is worn and must be replaced.
- D) If totalizer numerals (small numbers) on register are recording, but the big numerals are not moving, register needs repair.

PROBLEM: Product flows through meter but register does not record correctly.

- A) Adjuster assembly not properly calibrated, See METER CALIBRATION on page 13 for more instructions.
- B) The factory installed gear train may have incorrect gearing ratio.
- C) Check register for defects.

PROBLEM: No flow through meter.

- A) Faulty non-functioning pump.
- B) Foreign matter within the system, meter or components.
- C) Meter has a broken rotor or rotor shaft.
- D) Excessive wear on timing gears or bearings.
- E) Meter “frozen” due to build-up of chemical “salts” inside metering chamber, sufficient to stop rotation or rotors.
- F) Valve not open or not functioning.

PROBLEM: Meter runs too slow.

- A) There is a flow restriction within the system. (i.e.: tees, elbows, valves, etc.)
- B) Foreign matter in system, meter or components.
- C) Product viscosity is different or has changed from what was originally known.
- D) Meter gears or rotors partially “salted” enough to slow up rotation of parts.
- E) Valve internal mechanism faulty. Valve does not open fully or the linkage is not properly adjusted.

Air Eliminator Trouble Shooting



PROBLEM: Product is flowing from the Air Eliminators vents

- A) Foreign matter located in between seal plate orings and metal reeds.
- B) The seal plate oring may be worn through service life.
- C) The seal plate oring may be cut or dislodged and requires replacement.
- D) The float may have been punctured, containing liquid, not allowing the float to rise and seal the air vents.
- E) The float may have been ruptured from a surge of pressure within the system.
- F) The metal reeds may be fatigued and requires replacement.
- G) The metal reeds may be out of alignment with the seal plate.

PROBLEM: The meter is still registering air within the system

There can be numerous reasons why the meter may still register air. First look at the system configuration and see where air is being introduced into the system. Then determine if the meter is registering “free air” or “entrained air”. Free Air is much easier to remove from the metering system and may require the use of the Spring Loaded Back Check Valve and/or the Differential Air Check Valve and/or High Volume Strainer to help the air eliminator operate more effectively. Entrained Air is much more difficult to remove. Typically the best way to eliminate Entrained Air will be to remove the air source of entry into the system. Some examples are from cavitating pumps and leaking pump/valve seals. A High Volume Strainer may help accumulate the liquid long enough to disperse the Entrained Air from the system. See Air Elimination in the Service Manual for more information.

- A) The air return line is not the required minimum of 1/2” ID.
- B) The metering system has no sufficient way of eliminating the air to atmosphere. Example: Incorrectly installed “Catch Can” reservoir (lower than the air eliminator itself), or the reservoir is allowed to become full, incorrectly sized vent, etc...)

Preset Valve Trouble Shooting



PROBLEM: The valve will not close completely.

- A) The shaft of the piston may be bent from excessive force.
- B) Debris may be between the piston and piston guide.
- C) The upper or lower seals may be worn, swollen from incompatibility or cut from debris.
- D) The mechanical linkage to the Veeder Root 7889 preset counter may be tight. The linkage must be loose for the preset to operate correctly.
- E) The Veeder Root preset may have a worn or bent trip mechanism that is not allowing the preset to function.

PROBLEM: The valve shuts immediately upon first stage trip, bypassing the second stage closure.

- A) The mechanical linkage might need to be adjusted, moving the Nylon locking nuts forward or backwards to change the closing of the preset valve.
- B) The Veeder Root preset may need to be “raked” or adjusted for the correct shut-off volume. See Veeder Root 7889 preset service manual for further instructions.
- C) The Veeder Root preset may have a worn or bent trip mechanism that is not allowing the preset to function.

PROBLEM: The preset batch over or under registers correct volume.

- A) The mechanical linkage might need to be adjusted, moving the Nylon locking nuts forward or backwards to change the closing of the preset valve.
- B) The Veeder Root preset may need to be “raked” or adjusted for the correct shut-off volume. See Veeder Root 7889 preset service manual for further instructions.
- C) The Veeder Root preset may have a worn or bent trip mechanism that is not allowing the preset to function.

Material Safety Data Sheet

24 HOUR EMERGENCY ASSISTANCE
(260) 833-3173

GENERAL MSDS ASSISTANCE
(260) 484-0301

CODE: RPS

HAZARD RATING> LEAST-0 SLIGHT-1 MODERATE-2 HIGH-3 EXTREME-4

DR LUBRICANTS, INC.
4611 NEWAYGO ROAD, SUITE D
FORT WAYNE, IN 46808

DATE: 01/21/06
TELEPHONE NUMBER: (260) 484-0301

SECTION I - PRODUCT IDENTIFICATION

PRODUCT: **RP 1039**

PETRO

INDUSTRIAL

www.petroind.com

SECTION II - COMPOSITION AND HAZARDOUS INFORMATION*

CHEMICAL NAME	CAS NUMBER	WT. PERCENT IS LESS THAN	OCCUPATIONAL EXPOSURE LIMITS (TLV-TWA) (TLV-STEL)
PETROLEUM HYDROCARBON	64741-65-7	90.0	100MG/M3
PETROLEUM HYDROCARBON	64742-53-6	10.0	5MG/M3

*ITEMS NOT SHOWN ARE NOT LISTED IN THE OSHA - T.S.C.A. HAZARDOUS CHEMICALS LISTING.

SECTION III - PHYSICAL DATA

BOILING RANGE:	NA	VAPOR DENSITY:	NA
ODOR:	PETROLEUM ODOR	EVAPORATION RATE:	NA
APPEARANCE	AMBER LIQUID	SOLUBILITY:	INSOLUBLE
VOLATILE BY WEIGHT:	NA	PRODUCT DENSITY:	0.790
VOLATILE BY VOLUME:	NA		

SECTION IV - FIRE AND EXPLOSION HAZARD DATA

FLAMMABILITY CLASSIFICATION:	COMBUSTIBLE	FLASH POINT: 150 F (CLEVELAND OPEN CUP)	LEL: NA UEL: NA
DOT:	COMBUSTIBLE LIQUID		
EXTINGUISHING MEDIA:	CARBON DIOXIDE, DRY CHEMICAL, FOAM		

Material Safety Data Sheet (Continued)

PRODUCT: RP 1039
PAGE - 2

SECTION IV - FIRE AND EXPLOSION HAZARD DATA

UNUSUAL FIRE AND EXPLOSION HAZARDS : DO NOT DIRECT A SOLID STREAM OF WATER ONTO BURNING PRODUCT. THIS MAY CAUSE SPREADING AND INCREASE THE FIRES INTENSITY. COMBUSTION MAY PRODUCE: OXIDES OF CARBON, AND INCOMPLETELY BURNED HYDROCARBONS IN THE FORM OF FUMES AND SMOKE.

SPECIAL FIREFIGHTING PROCEDURES: WEAR A SELF-CONTAINED BREATHING APPARATUS WITH FULL FACEPIECE.

SECTION V - HEALTH HAZARD DATA

EFFECTS OF OVER EXPOSURE: MAY CAUSE MILD EYE IRRITATION AND REDNESS. PROLONGED OR REPEATED EXPOSURE TO THE SKIN MAY RESULT IN LOSS OF NATURAL OILS ACCOMPANIED BY DRYNESS, CRACKING AND DERMATITIS. INGESTION MAY RESULT IN NAUSEA, DIARRHEA AND GASTRO INTESTINAL IRRITATION. OVEREXPOSURE TO MIST MAY CAUSE UPPER RESPIRATORY TRACT IRRITATION AND DIFFICULTY BREATHING.

MEDICAL CONDITIONS PRONE TO AGGRAVATION BY EXPOSURE: NONE KNOWN.

PRIMARY ROUTE(S) OF ENTRY: DERMAL INHALATION INGESTION.

EMERGENCY AND FIRST AID PROCEDURES: IN CASE OF EYE CONTACT, IMMEDIATELY FLUSH EYES WITH CLEAN WATER FOR AT LEAST 15 MINUTES. IF EYE IRRITATION PERSISTS, CONTACT A PHYSICIAN. IN CASE OF SKIN CONTACT, REMOVE ANY CONTAMINATED CLOTHING AND RINSE SKIN THOROUGHLY WITH WATER FOR AT LEAST 15 MINUTES. IF SKIN IRRITATION PERSISTS, CONTACT A PHYSICIAN. IN CASE OF OVEREXPOSURE TO MIST, REMOVE VICTIM TO FRESH AIR: IF BREATHING IS DIFFICULT ADMINISTER OXYGEN: AND CONTACT A PHYSICIAN IMMEDIATELY. IF PRODUCT IS INGESTED DO NOT INDUCE VOMITING: CONTACT A PHYSICIAN.

SECTION VI - REACTIVITY DATA

STABILITY: THIS PRODUCT IS STABLE UNDER NORMAL STORAGE CONDITIONS.

HAZARDOUS POLYMERIZATION: WILL NOT OCCUR UNDER NORMAL CONDITIONS.

HAZARDOUS DECOMPOSITION PRODUCTS: THERMAL DECOMPOSITION MAY RESULT IN THE FORMATION OF: OXIDES OF CARBON, AND INCOMPLETELY BURNED HYDROCARBONS IN THE FORM OF FUMES AND SMOKE.

CONDITIONS TO AVOID: AVOID CONTACT WITH OPEN FLAME, STORE IN ROOM TEMPERATURE AREA.

Material Safety Data Sheet (Continued)

PRODUCT: RP 1039
PAGE - 3

INCOMPATIBILITY: AVOID CONTACT WITH STRONG OXIDIZING AND REDUCING AGENTS AND STRONG ALKLI.

SECTION VII - SPILL OR LEAK PROCEDURES

STEPS TO BE TAKEN IN CASE MATERIAL IS RELEASED OR SPILLED: FOR SMALL SPILLS: SOAK UP SPILL WITH ABSORBENT MATERIAL. FOR LARGE SPILLS: DIKE SPILL AND PUMP INTO DRUMS FOR PROPER DISPOSAL.

WASTE DISPOSAL METHOD: DISPOSE OF IN ACCORDANCE WITH ALL LOCAL STATE AND FEDERAL REGULATIONS.

SECTION VIII - SAFE HANDLING AND USE INFORMATION

RESPIRATORY PROTECTION: NORMALLY NOT REQUIRED, HOWEVER, WHEN THE TLV IS EXCEEDED WEAR THE APPROPRIATE MSHA/NIOSH APPROVED RESPIRATOR.

VENTILATION: PROVIDE ADEQUATE VENTILATION (SUCH AS MECHANICAL OR LOCAL) TO ASSURE TLV IS NOT EXCEEDED.

PROTECTIVE GLOVES: NORMALLY NOT REQUIRED, HOWEVER, IF HANDS ARE FREQUENTLY IN FLUID WEAR OIL AND CHEMICAL IMPERVIOUS GLOVES.

EYE PROTECTION: SAFETY GLASSES REQUIRED FOR NORMAL USAGE, WEAR CHEMICAL GOGGLES WHEN EXCESSIVE SPLASHING MAY OCCUR.

OTHER PROTECTIVE EQUIPMENT: NORMALLY NOT REQUIRED, HOWEVER, WHERE REPEATED CONTACT OCCURS, WEAR IMPERVIOUS CLOTHING AND BOOTS.

HYGIENIC PRACTICES: FOLLOW STANDARD INDUSTRIAL HYGIENE PRACTICES. LAUNDER ANY CONTAMINATED CLOTHING BEFORE RE-USE.

SECTION IX - SPECIAL PRECAUTIONS

PRECAUTIONS TO BE TAKEN IN HANDLING AND STORAGE: DO NOT STORE IN THE PRESENCE OF HEAT, SPARKS, FLAME OR ANY OTHER SOURCES OF IGNITION. STORE AWAY FROM STRONG OXIDIZING AGENTS. EMPTY DRUMS MAY CONTAIN PRODUCT RESIDUES. ALL SAFETY PRECAUTIONS TAKEN WHEN HANDLING THIS PRODUCT SHOULD ALSO BE TAKEN WHEN HANDLING EMPTY DRUMS AND CONTAINERS.

OTHER PRECAUTIONS: NONE

Material Safety Data Sheet (Continued)

PRODUCT: RP 1039
PAGE - 4

SECTION X - HMIS/NFPA RATINGS

HMIS:HEALTH:1 FLAMMABILITY:2 REACTIVITY:0 PERSONAL PROTECTION:C
NFPA:HEALTH:1 FLAMMABILITY:2 REACTIVITY:0 SPECIFIC HAZARD:

SECTION XI - OTHER REGULATORY INFORMATION

DOT HAZARDOUS: NATURAL DESCRIPTION:

THE INFORMATION CONTAINED HEREIN IS, TO THE BEST OF OUR KNOWLEDGE AND BELIEF, ACCURATE. HOWEVER, SINCE THE CONDITIONS OF HANDLING AND USE ARE BEYOND OUR CONTROL, WE MAKE NO GUARANTEE OF RESULTS, AND ASSUME NO LIABILITY FOR DAMAGES INCURRED BY USE OF THIS MATERIAL. IT IS THE RESPONSIBILITY OF THE USER TO COMPLY WITH ALL APPLICABLE FEDERAL, STATE AND LOCAL LAWS AND REGULATIONS.

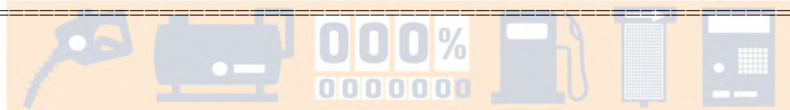

www.petroind.com

Notes



www.petroind.com

Warranty Information

Warranty

New 700 rotary meters, equipment or components manufactured by Total Control Systems, a division of Murray Equipment, Inc. (TCS) with which this warranty is enclosed, are warranted by TCS to the original purchaser only for a period of TWELVE (12) months from installation or EIGHTEEN (18) months from the date of shipment, to be free, under normal use and service, from defects in material and workmanship. Defects occurring within the stated warranty period, TCS will repair or replace, at TCS's option; provided that part or parts are returned to TCS transportation charges prepaid, and TCS's examination discloses the parts or workmanship to have been defective upon delivery to the purchaser.

Exclusions

This warranty does not cover any parts or equipment not manufactured by TCS or related companies. This warranty does not extend to any equipment that has been altered in any way, subjected to misuse, negligence, accident, or if operated in any manner other than in accordance with TCS's operating instructions or have been operated under conditions more severe than, or otherwise exceeding those set forth in the specifications. General maintenance, calibration, clean up and normal wear is excluded from this limited warranty.

Claim Procedures

In order to obtain performance by TCS of its obligations under this warranty, the original purchaser must obtain a Return Goods Authorization (RGA) number from TCS's customer service department within 30 days of discovery of a purported breach of warranty, but not later than the expiration of the warranty period. Once authorization is received, return the defective meter, piece of equipment, or component covered by this warranty, with transportation charges prepaid, to TCS at the address shown below together with a written statement setting forth the nature of the defect and RGA number.

Repair Warranty

All repair work is warranted for ninety (90) days from the date of shipment to customer. Some parts may be warranted for longer periods by the Original Equipment Manufacturer.

Design and Equipment Changes

Any changes in design or improvements added shall not create any obligation to install same on equipment previously sold or ordered.

Limitations

THERE ARE NO OTHER WARRANTIES OF ANY KIND, EXPRESS OR IMPLIED. TCS SPECIFICALLY DISCLAIMS ANY WARRANTY OR MERCHANTABILITY OR OF FITNESS FOR ANY PARTICULAR PURPOSE. TCS's sole obligation, which shall represent the buyer's sole and exclusive remedy, shall be to repair or at TCS's option, to replace any product or part determined to be defective. In no event shall TCS be liable for any special, direct, indirect, incidental, consequential or other damages of similar nature incurred by the buyer or any third party. TCS has not authorized on its behalf any representations or warranties to be made, nor any liability to be assumed except as expressly provided herein; there is no other express or implied warranty.

PETRO INDUSTRIAL



www.petroind.com

**TOTAL
CONTROL
TCS SYSTEMS**

"The Standard of Measurement"

2515 Charleston Place
Fort Wayne, IN 46808

Toll Free: (800) 348-4753
Phone: (260) 484-0382
Fax: (260) 484-9230
Email: sales@tcsimeters.com