



**BOXCHIP**

## **BOXCHIP S700A RADIO**

**S700A UHF: 400-470mhz**

**S700A VHF: 136-174mhz**

**Quick Start Guide**



# BOXCHIP

## BOXCHIP S700A RADIO

Thank you for purchasing the **BOXCHIP S700A** radio. This quick start guide will talk you through the basic features and functions of your new **S700A** radio.

### BOXCHIP S700A Overview



### Standard Included accessories:

- 1x Antenna (Model Dependent)
- 1x 3.8v 4500mAh Battery
- 1x USB C Cable
- 1x USB Charger
- 1x Belt Clip



# BOXCHIP

## S700 Series Antenna

The BOXCHIP S700 series have three antenna styles depending on the radio model - don't be alarmed if yours looks different to the images online.

- **S700A UHF:** 400-470mhz Antenna
- **S700A VHF:** 136-174mhz Antenna
- **S700B:** Short Antenna

## S700 Series Antenna Installation

Installing the *BOXCHIP S700A* antenna is as simple as screwing it on. Simply place the antenna on top of the SMA connector and screw clockwise.

**Please Note:** Once you start to feel resistance stop - **do not over tighten.**

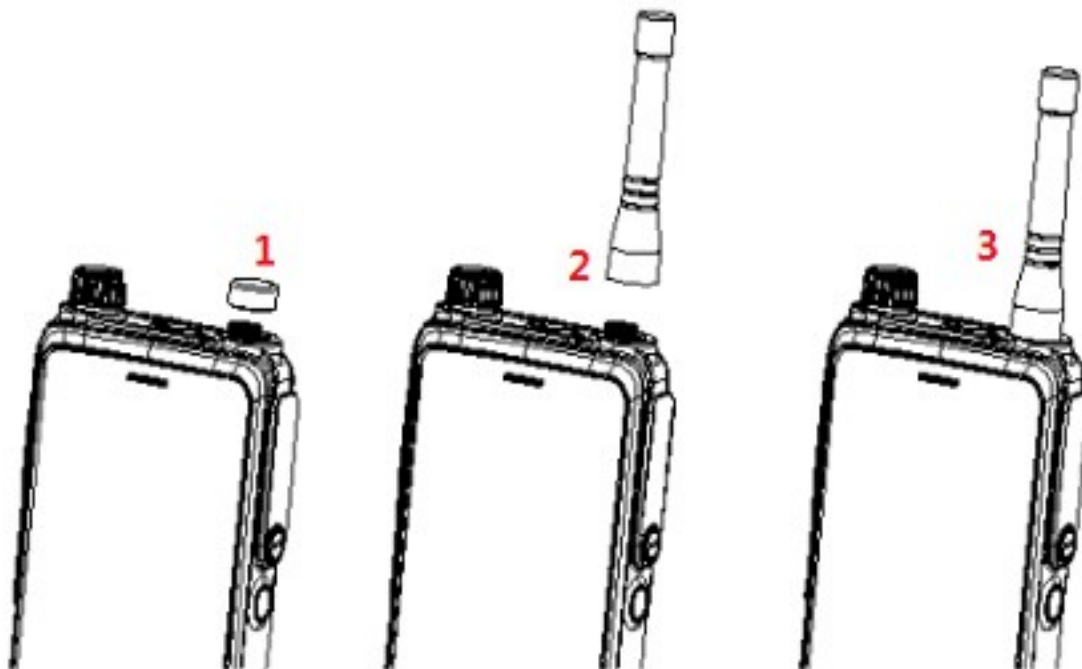



# BOXCHIP

## Dual SIM Card and Memory Card Installation

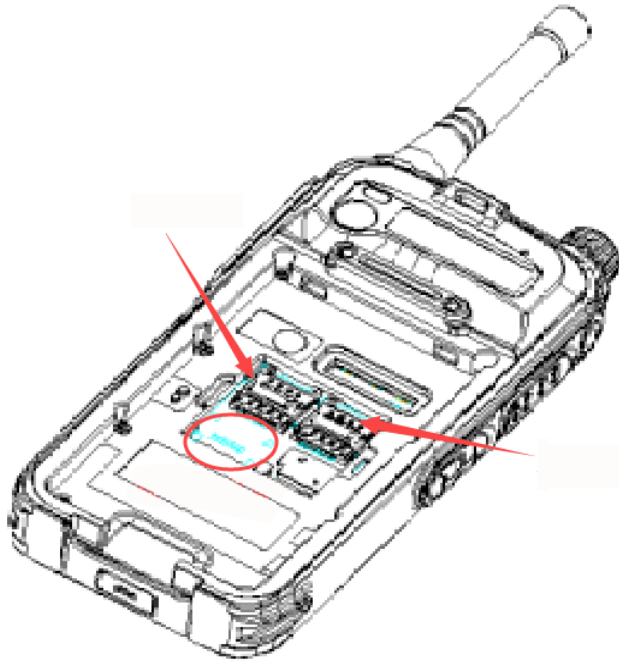

**Step 1:** Remove the battery if pre-installed. (Follow the battery installation and removal procedure below if you are unsure how to do this)

**Step 2:** Locate the black silicone cover which is located in the middle of the device.

**Step 3:** Insert a small tool under the notch located to the left hand side of the silicone cover and pry it off.

**Please note:** The silicone cover can be a little tough to remove as it forms a waterproof seal protecting the internal electronics.

**Step 4:** Install the SIM card and/or memory card by sliding the retainer to the 'open' position (as marked) and insert the SIM/memory card. Once inserted simply slide the retainer to the 'locked' position.

**Step 5:** Reassemble by pushing the silicone cover back into place and sliding the battery back on.



# BOXCHIP

## Battery Installation / Removal

### Battery Installation Procedure

**Step 1:** Slide the top tabs of the battery into the corresponding indents on the back of the radio housing

**Step 2:** Press down on the lower area of the battery to lock it into place.

**Please Note:** You will hear an audible click as it locks in place.

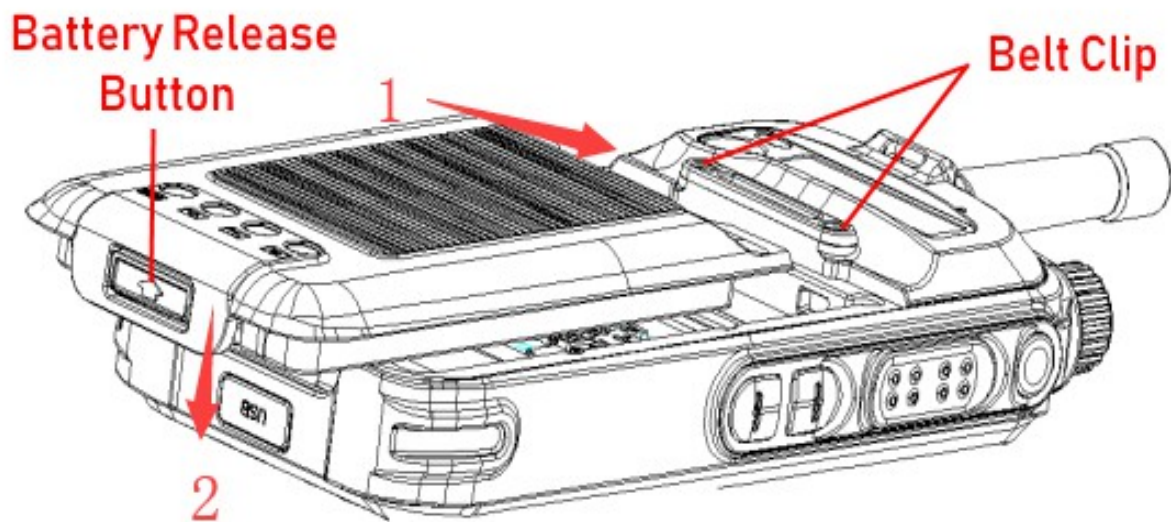

### Battery Removal Procedure

**Step 1:** Press and hold the bottom “” button on the battery while simultaneously lifting from the base of the battery.

**Step 2:** Slide the battery out towards the base of the device

### Belt Clip Installation (If Required)

**Step 1:** Place belt clip on top of the 2 corresponding belt clip installation holes at the rear of the device (just below the camera and *BOXCHIP* logo).

**Step 2:** Screw both screws in but do not over tighten.



# BOXCHIP

## Dock Charger (Optional Accessory)

**Step 1:** Plug the appropriate USB C cable into the back of the dock and into the USB wall charging socket.

**Step 2:** Slot the S700A or S700A battery into the dock as picture.

**Important:** Please read the information label at bottom of the dock before charging for the first time.

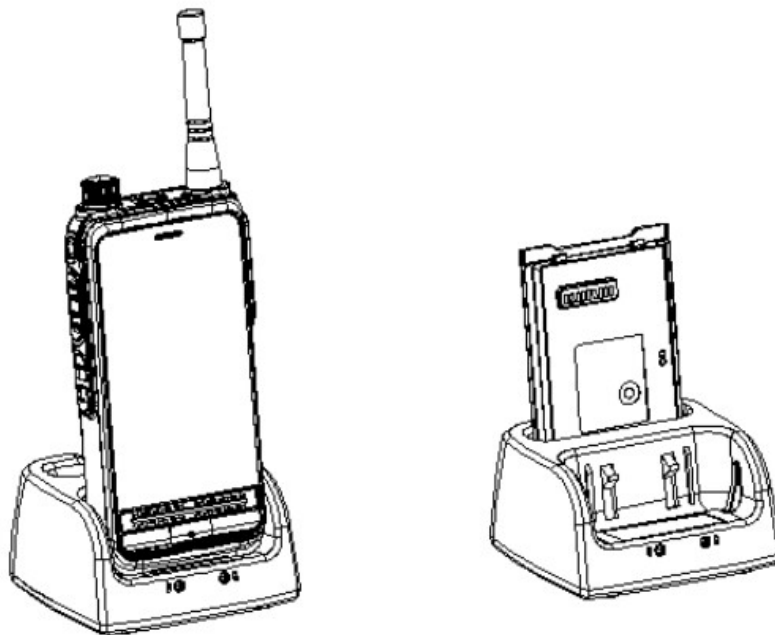

## What do the Different LED States Mean?

State in DMR Mode	LED Indication
PTT button is in DMR mode	Breathing Blue
Warning	Quick Blinking Blue
Error	Solid Red
Idle	Breathing Blue
Transmitting (TX)	Solid Blue
Transmission Inhibit/Failure	Quick Blinking Blue
Receiving (RX)	Solid Green
Hang Time Keeping	Breathing Green
Activity Over The Air Detected	Blinking Green
Emergency	Quick Blinking Blue



# BOXCHIP

## BOXCHIP BiMR

BiMR is *BOXCHIP*'s powerful proprietary DMR and Analogue Software that allows you to receive or transmit utilising the devices built in VHF or UHF radio.













## Configuring the BiMR / BPS Software

To configure your new radio simply download and install the BPS (*BOXCHIP* Programming Software) on your home computer or mac. The BPS software can be found by visiting the official *BOXCHIP* website: [www.boxchiptt.com](http://www.boxchiptt.com).

### Please Note:

You can find the complete BPS user guide within the BPS software installation folder. Please read this before programming your radio.

## BiMR Icons

Icon	states
 	Channel type: DMR or Analog
 	High Power or Low power
 	signal of DMR
  	DMO (direct mode operation) RMO (repeater mode operation) TLK (talk around mode)
	encryption
 	time slot A, time slot B(only for DMR)



## What PoC Software can be used with BOXCHIP Devices?

For the very best *BOXCHIP* PoC experience we can confirm full compatibility with the following PoC providers:

- Walkiefleet
- Eschat
- Tassta
- Mobiletorando
- Proptt2
- Realptt.
- Zello (lacks SOS functionality due to software limitations)

## More Information

If you require a little more information why not check out our online guides and videos or join the thriving *BOXCHIP* community - which is free to join!



### Instructions / Downloads



To download the latest instructions, firmware or software please visit the link below or scan the QR code.

<https://boxchiptt.com/>



### Accessories



To buy accessories or check out the very latest devices from BOXCHIP please visit the link below or scan the QR code.

<https://boxchiptt.com/collections/network-radio>



### Youtube



For in-depth device reviews and more, check out our latest videos on Youtube.

<https://goo.gl/E69wVo>



### Facebook



Join our online community and stay connected with the latest boxchip news, updates and more. Feel free to share your experiences and suggestions or even just connect with members from around the globe.

<https://www.facebook.com/groups/boxchip/>





**BOXCHIP**



**BOXCHIP**

BOXCHIP IS A LEADING GLOBAL MANUFACTURER OF INTELLIGENT COMMUNICATIONS. WE ARE COMMITTED TO USING TECHNOLOGY TO CHANGE THE RELATIONSHIP BETWEEN PEOPLE AND TECH.

**[www.boxchiptt.com](http://www.boxchiptt.com)**