

Eonis

19-inch clinical display

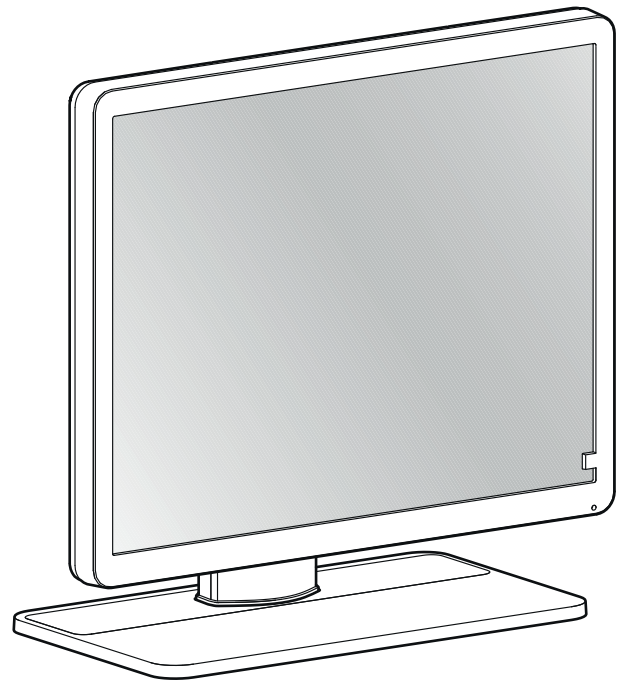

User Guide

MDRC-1219 HB TS
MDRC-1219 TS

MDRC-1219 HB
MDRC-1219

Barco NV

Beneluxpark 21, 8500 Kortrijk, Belgium
www.barco.com/en/support
www.barco.com

Registered office: Barco NV

President Kennedypark 35, 8500 Kortrijk, Belgium
www.barco.com/en/support
www.barco.com

Table of contents

1	Welcome!	5
1.1	What's in the box	6
1.2	Product overview	6
2	Installation	9
2.1	Cable connections	10
2.2	Display position adjustment	11
2.3	VESA-mount installation	11
3	Operation	13
3.1	Recommendations for daily operation	14
3.2	Standby switching	14
3.3	OSD menu use	14
3.4	Power status LED	15
3.5	Control wheel locking/unlocking	15
3.6	Input source selection	15
3.7	Luminance adjustment	16
3.8	sRGB color space	16
3.9	QAWeb presets	16
3.10	Display functions	16
3.11	White point selection	17
3.12	Analog video settings	17
3.13	Power save mode	18
3.14	OSD menu language	18
3.15	OSD menu orientation	18
3.16	Factory reset	19
3.17	Touchscreen	19
4	Maintenance	21
4.1	Scheduled maintenance	22
4.2	Cleaning	22
5	Important information	23
5.1	Safety information	24
5.2	Environmental information	26
5.3	Biological hazard and returns	28
5.4	Regulatory information	29

5.5	EMC notice	30
5.6	Explanation of symbols.....	32
5.7	Legal disclaimer.....	35
5.8	Technical specifications.....	36

Welcome!

1

Introduction

The MDRC-1219 is a 19" one megapixel color LCD display intended for review of medical images with a resolution of SXGA (1280*1024) and an aspect ratio of 5:4. The display is not intended for diagnosis.

There are 4 versions:

- MDRC-1219: standard version
- MDRC-1219 TS: version equipped with projective capacitive touchscreen
- MDRC-1219 HB: high bright version
- MDRC-1219 HB TS: high bright version equipped with projective capacitive touchscreen

Warnings, cautions, notes and tips

There are four levels of precautionary or advisory statements that may be used in this user guide. In descending order of importance, they are:



WARNING: Describes hazards or dangers that might result in personal injury or death.



CAUTION: Describes hazards that could damage the product.



Gives additional information about the described subject.



Gives extra advice about the described subject.

1.1 What's in the box

Overview

- 1x MDRC-1219 display
- 1x DisplayPort video cable
- 1x USB cable
- 1x printed User Guide (English)
- 1x system disc, containing QAWeb software and translations of the User Guide
- Mains cables



The user guides are also available on www.barco.com/support



Keep your original packaging. It is designed for this display and is the ideal protection during transport and storage.

1.2 Product overview

Front

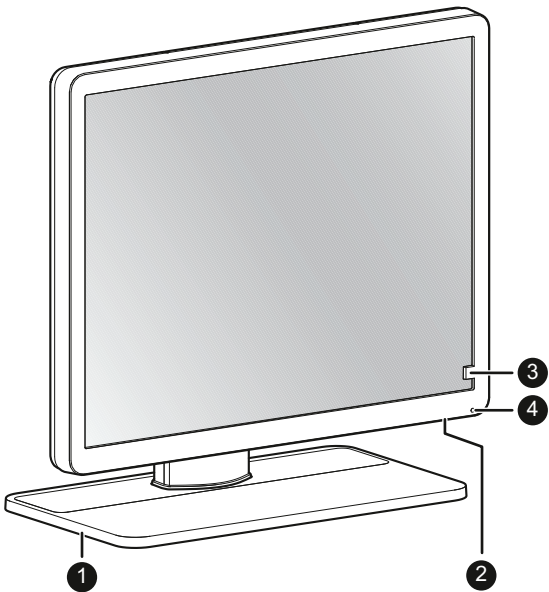

Image 1-1: MDRC-1219 and MDRC-1219 TS

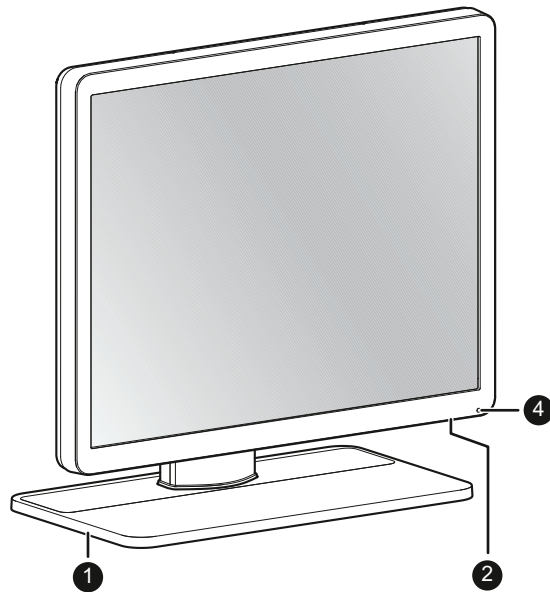

Image 1-2: MDRC-1219 HB and MDRC-1219 HB TS

1. Display stand
2. Control wheel
 - Push long (5 sec)
 - to put display in standby mode
 - Push short
 - to exit standby mode
 - to activate the OSD menu
 - to confirm selections in the OSD menu
 - Turn clockwise
 - to scroll down in the OSD menu
 - to increase values in the OSD menu
 - Turn counter clockwise
 - to scroll up in the OSD menu
 - to decrease values in the OSD menu
3. Front sensor (only for MDRC-1219 and MDRC-1219 TS)

4. Power status LED

- Off: Display not powered, or display is on but power LED function is disabled in OSD (see “Power status LED”, page 15)
- Steady green: Display operational
- Blinking green: Display is entering standby mode
- Steady orange: Display in standby mode

Back

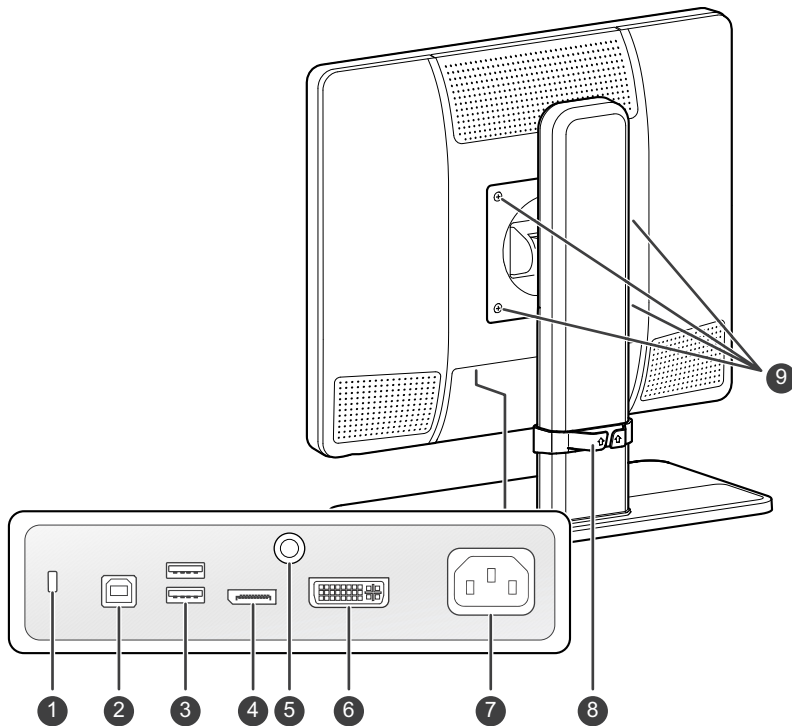

Image 1-3: MDRC-1219 and MDRC-1219 TS

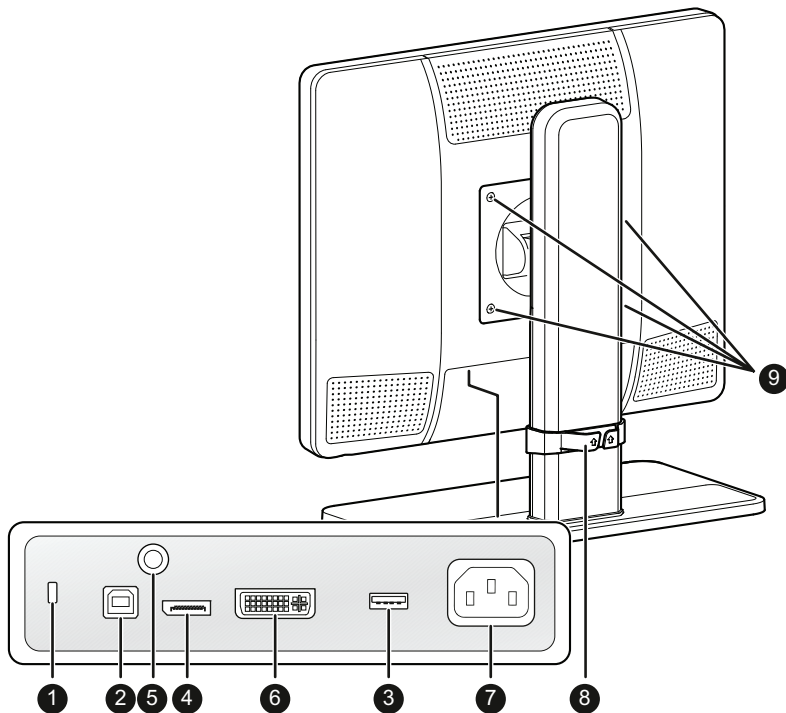

Image 1-4: MDRC-1219 HB and MDRC-1219 HB TS

1. Kensington security slot

Welcome!

2. USB-B 2.0 upstream connector
3. USB-A 2.0 downstream connectors (2x for MDRC-1219 and MDRC-1219 TS)
4. DisplayPort video input
5. Earth pin
6. DVI-I video input
7. 100 - 240 VAC mains power input (IEC C14)
8. Height-adjustable cable routing clip
9. VESA 100 mm mounting screw holes (4x)

Installation

2



WARNING: Read all the important safety information before installing and operating your monitor. Please refer to the dedicated chapter in this user guide.



WARNING: Sufficient expertise is required to install this equipment. All devices and complete setup must be tested before taking into operation.



CAUTION: When the display is assembled in the medical system, take care of the fixation of all cables, to avoid unwanted detachment.



CAUTION: The monitor is not intended to be sterilized.

2.1 Cable connections

To connect the cables

1. Connect one or more video source(s) to the corresponding video inputs. Use the appropriate video cable(s) to do this.

The input source to be displayed can be selected in the OSD menus (see “*Input source selection*”, page 15).

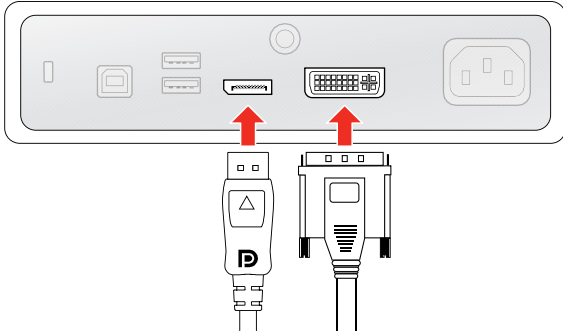

Image 2-1: MDRC-1219 and MDRC-1219 TS

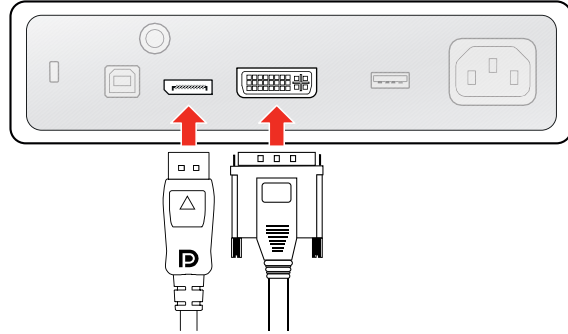

Image 2-2: MDRC-1219 HB and MDRC-1219 HB TS

2. Connect the USB upstream connector to a PC USB host to make use of QAWeb or any of the display USB downstream connectors (e.g. to connect a keyboard, mouse or other peripheral).



Image 2-3: MDRC-1219 and MDRC-1219 TS

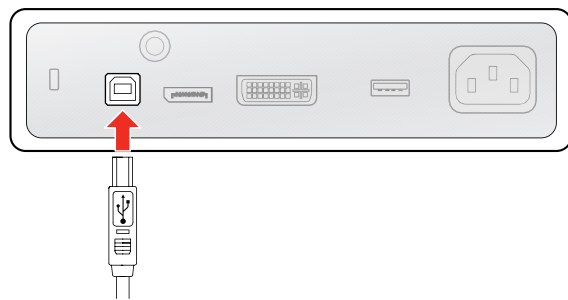

Image 2-4: MDRC-1219 HB and MDRC-1219 HB TS

3. Connect the mains power input to a **grounded** power outlet.

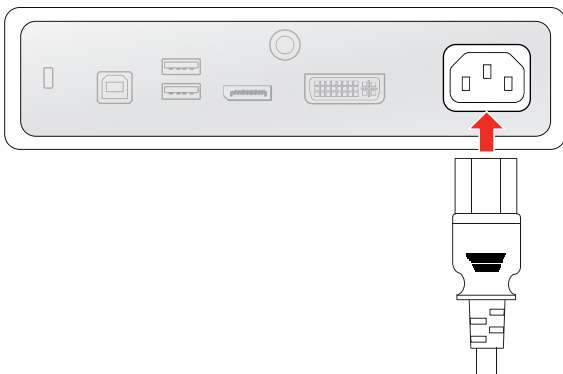

Image 2-5: MDRC-1219 and MDRC-1219 TS

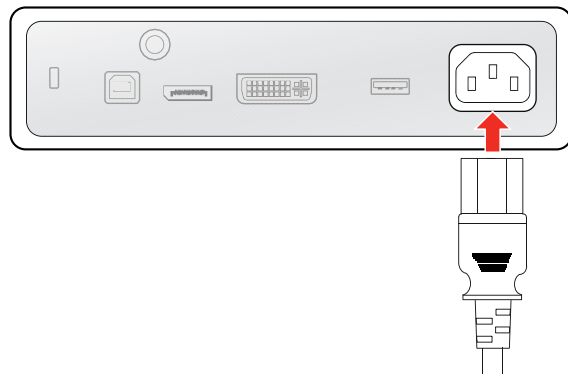

Image 2-6: MDRC-1219 HB and MDRC-1219 HB TS

4. If necessary for your application, earth the MDRC-1219 by connecting the earth pin to a grounded outlet by means of a yellow/green AWG18 wire (maximum admitted cable length according to national regulation requirements).

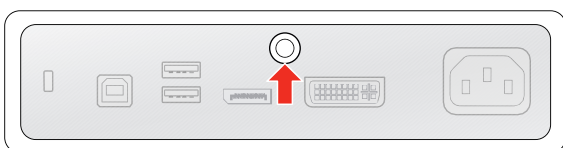

Image 2-7: MDRC-1219 and MDRC-1219 TS

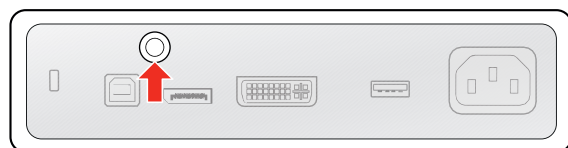

Image 2-8: MDRC-1219 HB and MDRC-1219 HB TS

5. Route all cables through the provided cable routing clip at the back of the display stand.

2.2 Display position adjustment

To adjust the display position

You can safely tilt, pivot, raise and lower the display as desired.

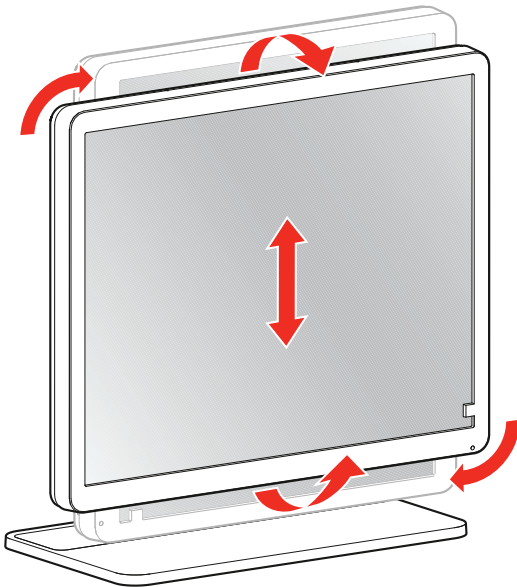

Image 2-9



WARNING: The display must be in its highest position before it can be properly pivoted.



The standard orientation of the video input is landscape. If you use the display in portrait mode, make sure you change the orientation of the video input via the screen settings of the computer.

2.3 VESA-mount installation

To mount the display on a VESA arm

The display panel, standard attached to the stand, is compatible with the VESA 100 mm standard.

1. Unscrew the four fixation screws to detach the panel from the stand.

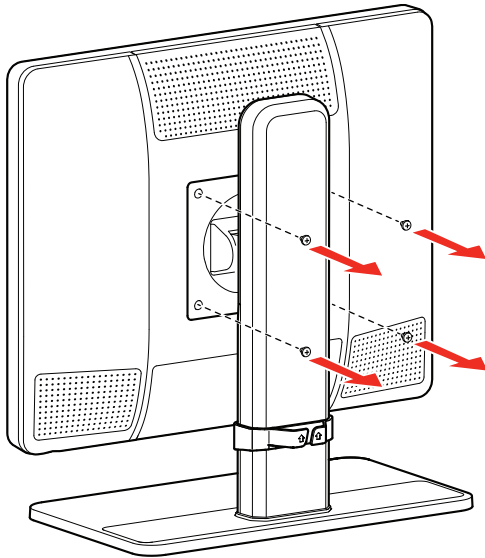

Image 2-10

2. Use 4 M4 screws to attach the panel to a VESA approved arm. Please respect the following rule to select an appropriate screw length:

- $L_{\min} = T + W + 8 \text{ mm}$
- $L_{\max} = T + W + 14 \text{ mm}$

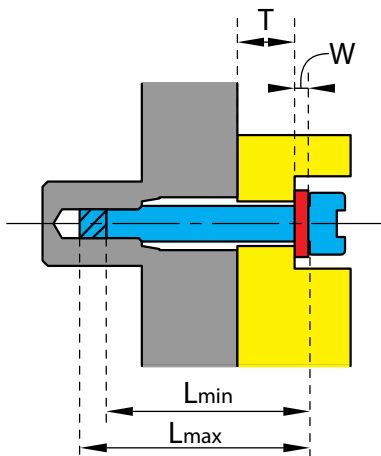

Image 2-11

3

Operation

3.1 Recommendations for daily operation

Optimize the lifetime of your display

Enabling the Display Power Management System (DPMS) of your display will optimize its lifetime by automatically switching off the backlight when the display is not used for a specified period of time. By default, DPMS is enabled on your display, but it also needs to be activated on your workstation. To do this, go to “Power Options Properties” in the “Control Panel”.



Barco recommends setting DPMS activation after 20 minutes of non-usage.

Use a screen saver to avoid image retention

Prolonged operation of an LCD with the same content on the same screen area may result in a form of image retention.

You can avoid or significantly reduce the occurrence of this phenomenon by using a screen saver. You can activate a screen saver in the “Display properties” window of your workstation.



Barco recommends setting screen saver activation after 5 minutes of non-usage. A good screen saver displays moving content.

In case you are working with the same image or an application with static image elements for several hours continuously (so that the screen saver is not activated), change the image content regularly to avoid image retention of the static elements.

Understand pixel technology

LCD displays use technology based on pixels. As a normal tolerance in the manufacturing of the LCD, a limited number of these pixels may remain either dark or permanently lit, without affecting the performance of the product. To ensure optimal product quality, Barco applies strict selection criteria for its LCD panels.



To learn more about LCD technology and missing pixels, consult the dedicated white papers available at www.barco.com/healthcare.

Maximize quality assurance

QAWeb guarantees optimum and stabilized image quality in every private practice.

The front sensor on the MDRC-1219 works seamlessly with QAWeb to ensure a consistent image over time. It automatically stabilizes the image from the moment you switch on the display. What's more, QAWeb provides you with instant feedback on the status of the display.

3.2 Standby switching

About

- Push the control wheel long (5 sec) to put your display in standby mode
- Push the control wheel short (1 sec) to exit standby mode and activate your display

3.3 OSD menu use

To open the OSD menu

Shortly push the control wheel during normal operation to open the OSD menu. If the control wheel is locked, first unlock it as described in “Control wheel locking/unlocking”, page 15.

The OSD main menu comes up in the left top of the screen. If no further actions are taken within the following 20 seconds, the OSD menu will disappear again (and the keyboard will lock if enabled).

To navigate the OSD menu

- Turn the control wheel (counter) clockwise to scroll through the different menu pages, to change values or to make selections.
- Push the control wheel to go into a submenu or confirm adjustments and selections.

3.4 Power status LED

Overview

The power status of the display is indicated by a LED at the front of the display. Below is an overview of the different LED color modes:

- Off: Not powered
- Steady green*: Operational
- Blinking green*: Entering standby mode
- Steady orange: In standby mode

* This default behavior can be changed so that the power status LED is also off when the display is operational or when entering standby mode.

To change the behavior of the power status LED

1. Bring up the OSD main menu.
2. Navigate to the *Adjustments > Settings* menu.
3. Enter the *Power Status LED* submenu.
4. Change the behavior of the power status LED as desired and confirm.

3.5 Control wheel locking/unlocking

About

To avoid unwanted or accidental activation of the control wheel, a lock mechanism can be enabled. This mechanism will lock the keyboard automatically, except while using the OSD menus.

To lock the control wheel

1. Bring up the OSD main menu.
2. Navigate to the *Adjustments > Settings > Keyboard lock* menu.
3. Switch the keyboard lock on or off.
4. Exit the OSD menu to activate the selected option.

To unlock the control wheel

During normal operation, turn and hold the control wheel **counter clockwise for 5 seconds**, until the *OSD unlocked* message appears.

3.6 Input source selection

About input source selection

The MDRC-1219 can have multiple video inputs connected. Switching between the different inputs can be done easily in the OSD menu.

To select the input source

1. Bring up the OSD main menu.
2. Navigate to the *Input selection* menu.
3. Select one of the available input sources and confirm.

3.7 Luminance adjustment

To adjust the luminance

1. Bring up the OSD main menu.
2. Navigate to the *Adjustments > Luminance* menu.
3. Set a luminance value as desired and confirm.

3.8 sRGB color space

About sRGB color space

The sRGB color space combines a display function and white point selection and is designed to match typical home and office viewing conditions. It is widely used in most computer applications.



When selecting *sRGB*, the *Display function* and *White point* selection options in the *Adjustments* menu will be disabled.

To select sRGB color space

1. Bring up the OSD main menu.
2. Navigate to the *Adjustments* menu.
3. Select *sRGB* and confirm.

3.9 QAWeb presets

About QAWeb presets

Display function, white point selection and ambient light conditions for your display can be applied from within the MediCal QAWeb application.



When selecting *QAWeb*, the *Display function* and *White point* selection options in the *Adjustments* menu will be disabled.

To select QAWeb presets

1. Bring up the OSD main menu.
2. Navigate to the *Adjustments* menu.
3. Select *QAWeb* and confirm.



The display USB upstream port must be connected to a PC with QAWeb installed on it before the QAWeb presets can be applied.

3.10 Display functions



Display function selection is disabled when *sRGB* or *QAWeb* are selected in the *Adjustments* menu.

About display functions

Native, uncorrected panels will display all grayscale/color levels with luminance increments that are not optimal for crucial diagnostic information. Studies have shown however, that in medical images certain grayscale/color parts contain more diagnostic information than others. To respond to these conclusions,

display functions have been defined. These functions emphasize on these parts containing crucial diagnostic information by correcting the native panel behavior.

The available display functions for your MDRC-1219 are:

- *Native*: If you select Native, the native panel behavior will not be corrected.
- *Gamma 1.8 or 2.2*: Select one of these display functions in case the display is to replace a CRT display with a gamma of 1.8 or 2.2 respectively.
- *DICOM*: DICOM (Digital Imaging and Communications in Medicine) is an international standard that was developed to improve the quality and communication of digital images in radiology. In short, the DICOM display function results in more visible grayscale in the images. Barco recommends selecting the DICOM display function for most medical viewing applications.

The DICOM display function applies ambient light compensation (ALC) taking the ambient light conditions of your reading room into account. The available reading room options are:

- *Darkroom*: Selects DICOM calibrated function, optimized for darkroom conditions (0-50 Lux)
- *Office*: Selects DICOM function optimized for office conditions (51-250 Lux)
- *Operation Room*: Selects DICOM function optimized for operating room conditions (251-500 Lux)



The settings of the display must be adapted to suit the requirements of the visualization software. In case of doubt, please contact the vendor of the visualization software.

To select a display function

1. Bring up the OSD main menu.
2. Navigate to the *Adjustments > Display function* menu.
3. Select one of the available display functions and confirm.

3.11 White point selection



White point selection is disabled when *sRGB* or *QAWeb* are selected in the *Adjustments* menu.

About white point selection

This setting allows you to modify the display white point, used as reference for all other colors to be displayed.

The available white point settings for your display are:

- *Native*: The native, unmodified color temperature of the LCD panel.
- *Bluebase*: Simulation of the bluebase film color temperature.
- *Clearbase*: Simulation of the clearbase film color temperature.
- *Programmable*: When selecting this setting, you will be able to manually adjust the video gain for the red, green and blue channel in separate submenus.

To select the white point

1. Bring up the OSD main menu.
2. Navigate to the *Adjustments > White point* menu.
3. Select one of the available white point presets.

3.12 Analog video settings



The following settings are only available when an analog video input source (DVI-A) is selected.

About analog video settings

When the analog video input source is active, a number of analog video settings becomes available:

- *Auto Adjust*: The analog video setting will automatically be adjusted
- *Geometry*: Allows to manually adjust the geometry settings of the analog video (clock frequency, clock phase, horizontal position, vertical position)
- *Level*: Allows to manually adjust the contrast and brightness levels of the analog video

To adjust the analog video settings

1. Bring up the OSD main menu.
2. Navigate to the *Adjustments > Analog* menu.
3. Adjust one of the available analog video settings as desired.

3.13 Power save mode

About power save mode

Enabling power save mode on your MDRC-1219 will optimize the display lifetime by automatically switching off the backlight when no video signal is detected after approximately 10 seconds.

To enable/disable power save mode

1. Bring up the OSD main menu.
2. Navigate to the *Adjustments > Settings* menu.
3. Enter the *Power save* submenu.
4. Select *On* or *Off* as desired and confirm.

3.14 OSD menu language

About the OSD menu language

By default, the OSD menu comes up in English. However, there's a wide range of other languages available for the OSD menu of your MDRC-1219.

To select the language of the OSD menu

1. Bring up the OSD main menu.
2. Navigate to the *Adjustments > Settings* menu.
3. Enter the *OSD Language* submenu.
4. Select one of the available languages.

3.15 OSD menu orientation

About the OSD menu orientation

The orientation of the OSD menu can be changed depending on the orientation of your display (landscape or portrait).

To change the orientation of the OSD menu

1. Bring up the OSD main menu.
2. Navigate to the *Adjustments > Settings* menu.

3. Enter the *OSD orientation* submenu.
4. Select *Landscape* or *Portrait* as desired and confirm.

3.16 Factory reset

About factory reset

A factory reset allows you to fully restore the display to its original factory setting.

To perform a factory reset

1. Bring up the OSD main menu.
2. Navigate to the *Adjustments > Settings* menu.
3. Enter the *Factory Reset* submenu.
4. Select *Yes* or *No* as desired and confirm.

3.17 Touchscreen

About touchscreen



This is only applicable for the MDRC-1219 TS and MDRC-1219 HB TS options.

- Touchscreen is interfacing via USB.
- Windows 7, 8 and 10: automatic installation of driver.
- Windows XP: requires a manual installation of a WinXP driver and is only supporting a single touch behavior.
- No calibration is required.

Maintenance

4

4.1 Scheduled maintenance

About

The MDRC-1219 does not require any scheduled maintenance or calibration activities. We recommend to use QAWeb with the Barco default tests and frequencies to calibrate and maintain the display, or to return the display to a Barco approved maintenance organization. In any case of doubts, please contact Barco Healthcare.

4.2 Cleaning



WARNING: Unplug the power cable from the mains power input before cleaning the display.



CAUTION: Take care not to damage or scratch the front glass or LCD. Be careful with rings or other jewelry and do not apply excessive pressure on the front glass or LCD.



CAUTION: Do not apply or spray liquid directly to the display as excess liquid may cause damage to internal electronics. Instead, apply the liquid to a cleaning cloth.

To clean the display

Clean the display using a sponge, cleaning cloth or soft tissue, lightly moistened with a recognized cleaning product for medical equipment. Read and follow all label instructions on the cleaning product. In case of doubt about a certain cleaning product, use plain water.

Possible cleaning solutions:

- 70% isopropyl alcohol
- 1.6% aqueous ammonia
- Cidex® (2.4% glutaraldehyde solution)
- Sodium hypochlorite (bleach) 10%
- "Green soap" (USP)
- 0.5% Chlorhexidine in 70% isopropyl alcohol
- Like Cleansafe® optical cleaning liquid

Do not use following products:

- Alcohol/solvents at higher concentration > 70%
- Strong alkalis lye, strong solvents
- Acid
- Detergents with fluoride
- Detergents with ammonia at higher concentration > 1.6%
- Detergents with abrasives
- Steel wool
- Sponge with abrasives
- Steel blades
- Cloth with steel thread

**Important
information**

5

5.1 Safety information

General recommendations

Read the safety and operating instructions before operating the device.

Retain safety and operating instructions for future reference.

Adhere to all warnings on the device and in the operating instructions manual.

Follow all instructions for operation and use.

Electrical Shock or Fire Hazard

To prevent electric shock or fire hazard, do not remove cover.

No serviceable parts inside. Refer servicing to qualified personnel.

Do not expose this apparatus to rain or moisture.

Modifications to the unit

Do not modify this equipment without authorization of the manufacturer.

Preventive maintenance

With the monitor disconnected from mains perform the following periodical check:

- Check the integrity of the power cord and inspect its routing, so that it is not under the risk of being punched or cut.
- Check the integrity of the Protective Earth connection.
- Clean the area around the power plug, dust and liquids may result in fire.
- Clean the ventilation slot of the monitor, dust can obstruct the air flow and cause temperature increase of the electronics.

General recommendations:

- Keep the monitor clean to prolong its operational lifetime.
- LCD panel performances may deteriorate in the long-term. Periodically check that it is correctly operating.
- Periodically check the tightness of the VESA mount screws. If not sufficiently tight, the monitor may detach from the arm, which may result in injury or equipment damage.

Type of protection (electrical):

Monitor with internal power supply: Class I equipment.

Degree of safety (flammable anesthetic mixture):

- Equipment not suitable for use in the presence of a flammable anesthetic mixture with air or with oxygen or nitrous oxide.
- The equipment shall not be operable when the air oxygen content is above 25%.

Non-patient care equipment

- Equipment primarily for use in a health care facility that is intended for use where contact with a patient is unlikely (no applied part).
- The equipment shall not be used with life support equipment.
- The user should not touch the equipment, nor its signal input ports (SIP)/signal output ports (SOP) and the patient at the same time.

Mission critical applications

We strongly recommend there is a replacement monitor immediately available in mission critical applications.

Use of electrical surgical knives

Provide as much distance as possible between the electrosurgical generator and other electronic equipment (such as monitors). An activated electrosurgical generator may cause interference with them and can disrupt the functionality of the display.

Power connection – Equipment with internal power supply

- This equipment must be earthed.
- Power requirements: The equipment must be powered by the AC mains voltage.
- The equipment is intended for continuous operation.

Transient over-voltage

To fully disengage the power to the device, please disconnect the power cord from the AC inlet.

Connections

- Any external connection with other peripherals must follow the requirements of clause 16 of IEC60601-1 3rd. Ed. or Table BBB.201 of IEC 60601-1-1 for the medical electrical systems.
- To maintain compliance with EMC Regulation, use only shielded interface cables for the connection to peripheral devices.

Power cords:

- Europe: H05VV-F or H05VVH2-F PVC cord with appropriate EU plug.
US and Canada: "hospital grade" cord-set has to be used, provided with instructions to indicate that grounding reliability can be achieved only when the equipment is connected to an equivalent receptacle marked hospital only or hospital grade. These instructions need to be marked either on the equip. or on a tag on the power cord
- Do not overload wall outlets and extension cords as this may result in fire or electric shock.
- Mains lead protection: Power cords should be routed so that they are not likely to be walked upon or pinched by items placed upon or against them, paying particular attention to cords at plugs and receptacles.
- The power supply cord should be replaced by the designated operator only at all time.
- Use a power cord that matches the voltage of the power outlet, which has been approved and complies with the safety standard of your particular country.

Grounding reliability

Grounding reliability can only be achieved when the equipment is connected to an equivalent receptacle.

Liquids and moisture

- Never expose the monitor to liquids or moisture.
- Never use the monitor near water - e.g. near a bathtub, washbasin, swimming pool, kitchen sink, laundry tub or in a wet basement.
- The equipment is IP20 compliant.

Moisture condensation

- Do not use monitor under rapid temperature and humidity change condition or avoid cold air from air-conditioning outlet directly.
- Moisture may condense on the surface or inside of the unit, or create a mist residue inside the protection plate, this is not a malfunction of the product itself, although it may cause damage to the monitor.
- If condensation happens, let the monitor stand unplugged until there is no condensation.

Ventilation

Do not cover or block any ventilation openings in the cover of the set. When installing the device in a cupboard or another enclosed location, heed the necessary space between the set and the sides of the cupboard.

Installation

- Place the device on a flat, solid and stable surface that can support the weight of at least 3 devices. If you use an unstable cart or stand, the device may fall, causing serious injury to a child or adult, and serious damage to the device.
- The display has been designed to be used in landscape and portrait position with a tilt of -5° to 22°.
- When the equipment is attached to an arm, do not use the equipment as a handle or grip in order to move the equipment. Please refer to the instruction manual of the arm for instructions on how to move the arm with the equipment.
- All devices and complete setup must be tested and validated before taking into operation.
- At end user application level it is necessary to foresee a backup unit in case the video falls away.

Malfunctions

Disconnect the equipment's power cord from the AC inlet and refer servicing to qualified service technicians under the following conditions:

- If the power cord or plug is damaged or frayed.
- If liquid has been spilled into the equipment.
- If the equipment has been exposed to rain or water.
- If the equipment does not operate normally when the operating instructions are followed. Adjust only those controls that are covered by the operating instructions since improper adjustment of other controls may result in damage and will often require extensive work by a qualified technician to restore the product to normal operation.
- If the equipment has been dropped or the cabinet has been damaged.
- If the product exhibits a distinct change in performance, indicating a need for service.

General warnings

- The device has no means to be incorporated in an IT-network in the clinical environment.
- The enclosure has to be checked upon collision damage, refer to qualified service personnel.
- The protective screen (if present) is made of tested high-resistance glass. Nonetheless there is the possibility that it may crack if subject to strong impacts. Evaluate and prevent the risk of possible breakages of the protective screen by correctly handling and positioning the monitor in the operating room.
- The monitor is intended for indoor use
- The monitor is not intended to be sterilized
- The monitor has not applied parts, but the front side of the LCD panel and the plastic enclosure have been treated as applied part because considered accidentally touchable by the patient for a time <1 minute.

National Scandinavian Deviations for CL. 1.7.2

Finland: "Laitte on liitettävä suojamaadoituskoskettimilla varustettuun pistorasiaan"

Norway: "Apparatet må tilkoples jordet stikkontakt"

Sweden: "Apparaten skall anslutas till jordat uttag"

5.2 Environmental information

Disposal Information

Waste Electrical and Electronic Equipment



■ This symbol on the product indicates that, under the European Directive 2012/19/EU governing waste from electrical and electronic equipment, this product must not be disposed of with other municipal waste. Please dispose of your waste equipment by handing it over to a designated collection point for the recycling of waste electrical and electronic equipment. To prevent possible harm to the environment or human health from uncontrolled waste disposal, please separate these items from other types of waste and recycle them responsibly to promote the sustainable reuse of material resources.

For more information about recycling of this product, please contact your local city office or your municipal waste disposal service.

For details, please visit the Barco website at: <http://www.barco.com/AboutBarco/weee>

Turkey RoHS compliance



■ Türkiye Cumhuriyeti: AEEE Yönetmeliğine Uygundur.

[Republic of Turkey: In conformity with the WEEE Regulation]

中国大陆 RoHS

Chinese Mainland RoHS

根据中国大陆《电器电子产品有害物质限制使用管理办法》（也称为中国大陆RoHS），以下部分列出了Barco产品中可能包含的有毒和/或有害物质的名称和含量。中国大陆RoHS指令包含在中国信息产业部MCV标准：“电子信息产品中有毒物质的限量要求”中。

According to the “Management Methods for the Restriction of the Use of Hazardous Substances in Electrical and Electronic Products” (Also called RoHS of Chinese Mainland), the table below lists the names and contents of toxic and/or hazardous substances that Barco’s product may contain. The RoHS of Chinese Mainland is included in the MCV standard of the Ministry of Information Industry of China, in the section “Limit Requirements of toxic substances in Electronic Information Products”.

零件项目(名称) Component name	有毒有害物质或元素 Hazardous substances and elements					
	铅 Pb	汞 Hg	镉 Cd	六价铬 Cr6+	多溴联苯 PBB	多溴二苯醚 PBDE
印制电路配件 Printed Circuit Assemblies	x	o	o	o	o	o
液晶面板 LCD panel	x	o	o	o	o	o
外接电(线)缆 External Cables	x	o	o	o	o	o
内部线路 Internal wiring	o	o	o	o	o	o
金属外壳 Metal enclosure	o	o	o	o	o	o
塑胶外壳 Plastic enclosure	o	o	o	o	o	o
散热片(器) Heatsinks	o	o	o	o	o	o
电源供应器 Power Supply Unit	x	o	o	o	o	o
风扇 Fan	o	o	o	o	o	o
文件说明书 Paper Manuals	o	o	o	o	o	o

零件项目(名称) Component name	有毒有害物质或元素 Hazardous substances and elements					
	铅 Pb	汞 Hg	镉 Cd	六价铬 Cr6+	多溴联苯 PBB	多溴二苯醚 PBDE
光盘说明书 CD manual	0	0	0	0	0	0
本表格依据SJ/T 11364的规定编制 This table is prepared in accordance with the provisions of SJ/T 11364. 0: 表示该有毒有害物质在该部件所有均质材料中的含量均在 GB/T 26572 标准规定的限量要求以下。 0: Indicates that this toxic or hazardous substance contained in all of the homogeneous materials for this part is below the limit requirement in GB/T 26572. x: 表示该有毒有害物质至少在该部件的某一均质材料中的含量超出 GB/T 26572 标准规定的限量要求。 x: Indicates that this toxic or hazardous substance contained in at least one of the homogeneous materials used for this part is above the limit requirement in GB/T 26572.						

在中国大陆销售的相应电子信息产品（EIP）都必须遵照中国大陆《电子电气产品有害物质限制使用标识要求》标准贴上环保使用期限（EFUP）标签。Barco产品所采用的EFUP标签（请参阅实例，徽标内部的编号用于指定产品）基于中国大陆的《电子信息产品环保使用期限通则》标准。

All Electronic Information Products (EIP) that are sold within Chinese Mainland must comply with the “Marking for the restriction of the use of hazardous substances in electrical and electronic product” of Chinese Mainland, marked with the Environmental Friendly Use Period (EFUP) logo. The number inside the EFUP logo that Barco uses (please refer to the photo) is based on the “General guidelines of environment-friendly use period of electronic information products” of Chinese Mainland.



中国RoHS自我声明符合性标志 / China RoHS – SDoC mark

本产品符合《电器电子产品有害物质限制使用管理办法》和《电器电子产品有害物质限制使用达标管理目录》的要求。

This product meets the requirements of the “Management Rule on the Use Restriction of Hazardous Substances in Electrical and Electronic Products” and the “Management Catalogue for the Use Restriction of Hazardous Substances in Electrical and Electronic Products”.



绿色自我声明符合性标志可参见电子档文件

The green SDoC mark is visible in the digital version of this document.

5.3 Biological hazard and returns

Overview

The structure and the specifications of this device as well as the materials used for manufacturing makes it easy to wipe and clean and therefore suitable to be used for various applications in hospitals and other medical environments, where procedures for frequent cleaning are specified.

However, normal use shall exclude biological contaminated environments, to prevent spreading of infections.

Therefore use of this device in such environments is at the exclusive risk of Customer. In case this device is used where potential biological contamination cannot be excluded.

Customer shall implement the decontamination process as defined in the latest edition of the ANSI/AAMI ST35 standard on each single failed Product that is returned for servicing, repair, reworking or failure investigation to Seller (or to the Authorized Service Provider). At least one adhesive yellow label shall be

attached on the top site of the package of returned Product and accompanied by a declaration statement proving the Product has been successfully decontaminated.

Returned Products that are not provided with such external decontamination label, and/or whenever such declaration is missing, can be rejected by Seller (or by the Authorized Service Provider) and shipped back at Customer expenses.

5.4 Regulatory information

Indications for use

This display is intended to be used for viewing medical images by medical practitioners.

Intended usage environment

This display can also be used in the patient area.

Contra-indications

This display is not intended to be used for direct diagnosis and therapeutic interventional radiology.

Intended users

Clinical review displays are intended to be used by trained medical practitioners.

Notice to the user and/or patient

Any serious incident that has occurred in relation to the device should be reported to the manufacturer and the competent authority of the Member State in which the user and/or patient is established.

Manufacturing country

The manufacturing country of the product is indicated on the product label (“**Made in ...**”).

Importers contact information

To find your local importer, contact one of Barco’s regional offices via the contact information provided on our website (www.barco.com).

FCC class B

This device complies with Part 15 of the FCC Rules. Operation is subject to the following two conditions: (1) this device may not cause harmful interference, and (2) this device must accept any interference received, including interference that may cause undesired operation.

This device has been tested and found to comply with the limits for a Class B digital device, pursuant to Part 15 of the FCC Rules. These limits are designed to provide reasonable protection against harmful interference in a residential installation. This device generates, uses and can radiate radio frequency energy and, if not installed and used in accordance with the instructions, may cause harmful interference to radio communications. However, there is no guarantee that interference will not occur in a particular installation. If this device does cause harmful interference to radio or television reception, which can be determined by turning the device off and on, the user is encouraged to try to correct the interference by one or more of the following measures:

- Reorient or relocate the receiving antenna.
- Increase the separation between the device and receiver.
- Connect the device into an outlet on a circuit different from that to which the receiver is connected.
- Consult the dealer or an experienced radio/TV technician for help.

Changes or modifications not expressly approved by the party responsible for compliance could void the user’s authority to operate the equipment.

FCC responsible: Barco Inc., 3059 Premiere Parkway Suite 400, 30097 Duluth GA, United States, Tel: +1 678 475 8000

Canadian notice

CAN ICES-3 (B)/NMB-3(B)

5.5 EMC notice

General information

This device is for use in professional healthcare facility environments only.

With the installation of the device, use only the delivered external cables and power supply or a spare part provided by the legal manufacturer. Using another can result in a decrease of the immunity level of the device.



WARNING: Use of this equipment adjacent to or stacked with other equipment should be avoided because it could result in improper operation. If such use is necessary, this equipment and the other equipment should be observed to verify that they are operating normally.



WARNING: Use of accessories, transducers and cables other than those specified or provided by the manufacturer of this equipment could result in increased electromagnetic emissions or decreased electromagnetic immunity of this equipment and result in improper operation.



WARNING: Portable RF communications equipment (including peripherals such as antenna cables and external antennas) should be used no closer than 30 cm (12 inches) to any part of the MDRC-1219, including cables specified by the manufacturer. Otherwise, degradation of the performance of this equipment could result.

Electromagnetic emissions

The MDRC-1219 is intended for use in the electromagnetic environment specified below. The customer or the user of the MDRC-1219 should assure that it is used in such an environment.

Emissions test	Compliance	Electromagnetic environment – Guidance
RF emissions CISPR 11	Group 1	The MDRC-1219 uses RF energy only for its internal function. Therefore, its RF emissions are very low and are not likely to cause any interference in nearby electronic equipment.
RF emissions CISPR 11	Class B	The MDRC-1219 is suitable for use in all establishments, including domestic establishments and those directly connected to the public low-voltage power supply network that supplies buildings used for domestic purposes.
Harmonic emissions IEC 61000-3-2	Not applicable ¹	
Voltage fluctuations/ flicker emissions IEC 61000-3-3	Complies	

This MDRC-1219 complies with appropriate medical EMC standards on emissions to, and interference from surrounding equipment. Operation is subject to the following two conditions: (1) this device may not cause harmful interference, and (2) this device must accept any interference received, including interference that may cause undesired operation.

Interference can be determined by turning the equipment off and on.

If this equipment does cause harmful interference to, or suffer from harmful interference of, surrounding equipment, the user is encouraged to try to correct the interference by one or more of the following measures:

- Reorient or relocate the receiving antenna or equipment.
- Increase the separation between the equipment and receiver.
- Connect the equipment into an outlet on a circuit different from that to which the receiver is connected.
- Consult the dealer or an experienced technician for help.

¹: Active power for MDRC-1219 is less than 75 W

Electromagnetic immunity

The MDRC-1219 is intended for use in the electromagnetic environment specified below. The customer or the user of the MDRC-1219 should assure that it is used in such an environment.

Immunity test	IEC 60601 test levels	Compliance level	Electromagnetic environment – guidance
Electrostatic discharge (ESD) IEC 61000-4-2	± 8 kV contact ± 2 kV, ± 4 kV, ± 8 kV, ± 15 kV air	± 8 kV contact ± 2 kV, ± 4 kV, ± 8 kV, ± 15 kV air	Floors should be wood, concrete or ceramic tile. If floors are covered with synthetic material, the relative humidity should be at least 30%
Electrical fast transient/burst IEC 61000-4-4	± 2 kV for power supply lines ± 1 kV for input/ output lines 100 kHz repetition frequency	± 2 kV for power supply lines ± 1 kV for input/ output lines 100 kHz repetition frequency	Mains power quality should be that of a typical commercial or hospital environment
Surge IEC61000-4-5	Line to line: ± 0.5 kV, ± 1 kV Line to ground: ± 0.5 kV, ± 1 kV, ± 2 kV	Line to line: ± 0.5 kV, ± 1 kV Line to ground: ± 0.5 kV, ± 1 kV, ± 2 kV	Mains power quality should be that of a typical commercial or hospital environment
Voltage dips, short interruptions and voltage variations on power supply input lines IEC 61000-4-11	0% residual voltage for 0.5 period at 0°, 45°, 90°, 135°, 180°, 225°, 270° and 315° 0% residual voltage for 1 period at 0° 70% residual voltage for 25 periods at 0° Voltage interruptions: 0% residual voltage for 250 periods at 0°	0% residual voltage for 0.5 period at 0°, 45°, 90°, 135°, 180°, 225°, 270° and 315° 0% residual voltage for 1 period at 0° 70% residual voltage for 25 periods at 0° Voltage interruptions: 0% residual voltage for 250 periods at 0°	Mains power quality should be that of a typical commercial or hospital environment. If the user of the MDRC-1219 requires continued operation during power mains interruptions, it is recommended that the MDRC-1219 be powered from an uninterruptible power supply or a battery
Power frequency (50/60 Hz) magnetic field IEC 61000-4-8	30 A/m	Not applicable ²	Power frequency magnetic fields should be at levels characteristic of a typical location in a typical commercial or hospital environment
Conducted RF IEC 61000-4-6	3 Vrms (6 Vrms in ISM bands) 150 kHz to 80 MHz	3 Vrms (6 Vrms in ISM bands)	
Radiated RF IEC 61000-4-3	3 V/m 80 MHz to 2.7 GHz	10 V/m	

Immunity to RF wireless communications equipment

Test frequency (MHz)	Band (MHz)	Service	Modulation	Maximum power (W)	Distance (m)	Immunity test level (V/m)
385	380 – 390	TETRA 400	Pulse modulation 18 Hz	1.8	0.3	27
450	430 – 470	GMRS 460, FRS 460	FM ± 5 kHz deviation 1 kHz sine	2	0.3	28





²: MDRC-1219 doesn't contain susceptible components to magnetic fields















Test frequency (MHz)	Band (MHz)	Service	Modulation	Maximum power (W)	Distance (m)	Immunity test level (V/m)
710	704 – 787	LTE Band 13, 17	Pulse modulation 217 Hz	0.2	0.3	9
745						
780						
810	800 – 960	GSM 800/900, TETRA 800, iDEN 820, CDMA 850, LTE Band 5	Pulse modulation 18 Hz	2	0.3	28
870						
930						
1720	1700 – 1990	GSM 1800, CDMA 1900, GSM 1900, DECT, LTE Band 1/3/4/25, UMTS	Pulse modulation 217 Hz	2	0.3	28
1845						
1970						
2450	2400 – 2570	Bluetooth, WLAN, 802.11 b/g/n, RFID 2450, LTE Band 7	Pulse modulation 217 Hz	2	0.3	28
5240	5100 – 5800	WLAN 802.11 a/n	Pulse modulation 217 Hz	0.2	0.3	9
5500						
5785						











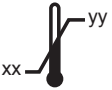



5.6 Explanation of symbols

Symbols on the device

On the device or power supply, you may find the following symbols (nonrestrictive list):

	Indicates the device meets the requirements of the applicable EC directives/regulations.
	Indicates compliance with Part 15 of the FCC rules (Class A or Class B).
	Indicates the device is approved according to the UL Recognition regulations.
	MEDICAL – GENERAL MEDICAL EQUIPMENT AS TO ELECTRICAL SHOCK, FIRE AND MECHANICAL HAZARDS ONLY IN ACCORDANCE WITH ANSI/AAMI AS60601-1:2005/(R)2012, CSA CAN/CSA-C22.2 NO. 60601-1:14
	Indicates the device is approved according to the UL regulations for Canada and US.



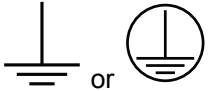

	Indicates the device is approved according to the UL Demko regulations.
	Indicates the device is approved according to the CCC regulations.
	Indicates the device is approved according to the VCCI regulations.
	Indicates the device is approved according to the KC regulations.
	Indicates the device is approved according to the BSMI regulations.
	Indicates the device is approved according to the PSE regulations.
	Indicates the device is approved according to the RCM regulations.
	Indicates the device is approved according to the EAC regulations.
	Caution: Federal law (United States of America) restricts this device to sale by or on the order of a licensed healthcare practitioner.
	Indicates the device is approved according to the BIS regulations.
	Indicates the device is approved according to the INMETRO regulations.
	Indicates the USB connectors on the device.
	Indicates the DisplayPort connectors on the device.
	Indicates the legal manufacturer.
	Indicates the manufacturing date.

	Indicates the temperature limitations ³ for the device to safely operate within specs.
	Indicates this is a Medical Device.
	Indicates the device serial number.
	Indicates the device part number or catalogue number.
	Indicates the Unique Device Identifier.
	Warning: dangerous voltage
	Caution
	Consult the Instructions For Use.
	Consult the Instruction For Use on website address that is provided as eIFU indicator.
	Indicates this device must not be thrown in the trash but must be recycled, according to the European WEEE (Waste Electrical and Electronic Equipment) directive.
	Indicates Direct Current (DC).
	Indicates Alternating Current (AC).
	Stand-by
	Equipotentiality
	Protective earth (ground)

³: Values for xx and yy can be found in the technical specifications paragraph.

Symbols on the box

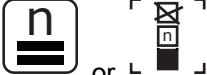
On the box of the device, you may find the following symbols (nonrestrictive list):

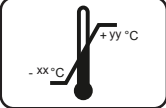
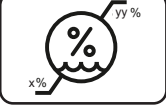
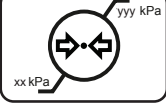
	Indicates a device that can be broken or damaged if not handled carefully when being stored.
	Indicates a device that needs to be protected from moisture when being stored.
	Indicates the storage direction of the box. The box must be transported, handled and stored in such a way that the arrows always point upwards.
	Indicates the maximum number of identical boxes which may be stacked on each other, where "n" is the limiting number.
	Indicates the weight of the box and that it should be carried with two persons.
	Indicates that the box should not be cut with a knife, a cutter or any other sharp object.
	Indicates the temperature limits ⁴ to which the device can be safely exposed when being stored.
	Indicates the range ⁴ of humidity to which the device can be safely exposed when being stored.
	Indicates the range ⁴ of atmospheric pressure to which the device can be safely exposed when being stored.

5.7 Legal disclaimer

Disclaimer notice

Although every attempt has been made to achieve technical accuracy in this document, we assume no responsibility for errors that may be found. Our goal is to provide you with the most accurate and usable documentation possible; if you discover errors, please let us know.

Barco software products are the property of Barco. They are distributed under copyright by Barco NV or Barco Inc., for use only under the specific terms of a software license agreement between Barco NV or Barco Inc. and the licensee. No other use, duplication, or disclosure of a Barco software product, in any form, is authorized.

The specifications of Barco products are subject to change without notice.

Trademarks

All trademarks and registered trademarks are property of their respective owners.

⁴: Values for xx and yy can be found in the technical specifications paragraph.

Copyright notice

This document is copyrighted. All rights are reserved. Neither this document, nor any part of it, may be reproduced or copied in any form or by any means - graphical, electronic, or mechanical including photocopying, taping or information storage and retrieval systems - without written permission of Barco.

© 2020 Barco NV all rights reserved.

5.8 Technical specifications

Overview

Screen technology	Standard versions: IPS TFT High bright versions: IPS AHVA
Active screen size (diagonal)	482 mm (19.0")
Active screen size (H x V)	376 x 301 mm (14.81 x 11.85")
Aspect ratio (H:V)	5:4
Resolution	1MP (1280 x 1024 pixels)
Pixel pitch	0.294 mm
Color imaging	Yes
Gray imaging	Yes
Bit depth	8 bit (DVI) 10 bit (DisplayPort)
Viewing angle (H, V)	178°
Ambient light presets	Yes, reading room selection
Backlight Output Stabilization (BLOS)	Standard versions: No High bright versions: Yes
Front sensor	Standard versions: Yes, Front Consistency Sensor High bright versions: No
Maximum luminance (panel typical)	Standard versions: 330 cd/m ² High bright versions: 700 cd/m ²
DICOM calibrated luminance	Standard versions: 250 cd/m ² High bright versions: 400 cd/m ²
Contrast ratio (panel typical)	Standard versions: 1000:1 High bright versions: 900:1
Response time ((Tr + Tf)/2) (typical)	Standard versions: 15 ms High bright versions: 12.5 ms
Housing color	Black
Video input signals	DVI (DVI-D and DVI-A) DisplayPort
USB ports	1x USB 2.0 upstream (endpoint) Standard versions: 2x USB 2.0 downstream High bright versions: 1x USB 2.0 downstream

Power requirements	Internal power supply (100-240 Vac, 50/60 Hz)
Power consumption	Standard versions: 22 W (nominal) High bright versions: 25 W (nominal) < 0.5 W (standby)
Dimensions with stand (W x H x D)	Portrait: 348 x 440~550 x 201 mm Landscape: 411 x 408~518 x 201 mm
Dimensions w/o stand (W x H x D)	411 x 348 x 67 mm
Dimensions packaged (W x H x D)	426 x 592 x 326 mm
Net weight with stand	MDRC-1219: 5.3 kg MDRC-1219 (option TS): 6.1 kg MDRC-1219 (option HB): 5.4 kg MDRC-1219 (option HB TS): 6.2 kg
Net weight w/o stand	MDRC-1219: 3.1 kg MDRC-1219 (option TS): 3.9 kg MDRC-1219 (option HB): 3.2 kg MDRC-1219 (option HB TS): 4.0 kg
Net weight packaged	MDRC-1219: 8.1 kg MDRC-1219 (option TS): 8.9 kg MDRC-1219 (option HB): 7.4 kg MDRC-1219 (option HB TS): 8.2 kg
Tilt	-5° to +22°
Swivel	N/A
Pivot	90°
Height adjustment range	110 mm
Mounting standard	VESA (100 mm)
Screen protection	Touch versions: PCAP touchscreen Other versions: N/A
Recommended modalities	Reviewing of digital images
Certifications	Standard versions: FDA Class I, 510(k) exempt CE (Medical Device Class I) CCC (China), Inmetro (Brazil), KC (Korea), BIS (India), EAC (Russia, Kazakhstan, Belarus, Armenia and Kyrgyzstan) Safety specific: IEC 60950-1:2005 +A1:2009 +A2:2013 EN 60950-1:2006 + A1:2010 + A11:2009 + A12:2011 + A2:2013 IEC 60601-1: 2005 + CORR. 1:2006 + CORR. 2:2007 + AM1:2012 EN 60601-1:2006 + A1:2013 + A12:2014 ANSI/AAMI ES 60601-1:2005 + R1:2012 CAN/CSA C22.2 No. 60601-1:2014 EMI specific: IEC 60601-1-2: 2014 (ed4) EN 60601-1-2: 2015 (ed4)

	<p>ICES-003 Level B</p> <p>Environmental: China Energy Label, EU RoHS, China RoHS, REACH, Canada Health, WEEE, Packaging Directive</p> <p>High bright versions: FDA Class I,510(k) exempt CE (Medical Device Class I)</p> <p>Safety specific: IEC 60950-1:2005 +A1:2009 +A2:2013 EN 60950-1:2006 + A1:2010 + A11:2009 + A12:2011 + A2:2013 IEC 60601-1: 2005 + CORR. 1:2006 + CORR. 2:2007 + AM1:2012 EN 60601-1:2006 + A1:2013 + A12:2014 ANSI/AAMI ES 60601-1:2005 + R1:2012 CAN/CSA C22.2 No. 60601-1:2014</p> <p>EMI specific: IEC 60601-1-2: 2014 (ed4) EN 60601-1-2: 2015 (ed4)</p> <p>ICES-003 Level B</p> <p>Environmental: EU RoHS, REACH, Canada Health, WEEE, Packaging Directive</p>
Supplied accessories	<p>1x DisplayPort video cable</p> <p>1x USB cable</p> <p>1x printed User Guide (English)</p> <p>1x system disc, containing QAWeb software and translations of the User Guide</p> <p>Mains cables</p>
QA software	MediCal QAWeb
Warranty	3 years
Operating temperature	<p>Standard versions: 0 °C to +35 °C</p> <p>High bright versions: 0°C to +40 °C</p>
Storage temperature	-20 °C to +60 °C
Operating humidity	<p>Standard versions: 20 % to 80 % (non-condensing)</p> <p>High bright versions: 8 % to 80 % (non-condensing)</p>
Storage humidity	<p>Standard versions: 10 % to 90 % (non-condensing)</p> <p>High bright versions: 5 % to 90 % (non-condensing)</p>
Operating pressure	70 kPa minimum
Storage pressure	50 to 106 kPa



Barco NV
President Kennedypark 35
8500 Kortrijk
Belgium

K5902137 (451920612606) /05 | 2020-02-25

Barco NV | Beneluxpark 21, 8500 Kortrijk, Belgium
Registered office: Barco NV | President Kennedypark 35, 8500 Kortrijk, Belgium
www.barco.com