

User's guide for

DiagnosticPRO™ *Edge*

- Multi-film feeder

Serial numbers
380,000 to 389,999

© Copyright 2013 by VIDAR® Systems Corporation. All rights reserved.

Terms denoted by the trademark symbol (™ or ®) used in this publication are trademarks or service marks registered in the United States or other countries.

NOTE

The digitizers do not include application specific software (Picture Archiving and Communications [PAC] system, Teleradiology, Oncology Systems, or Computer Aided Detection [CAD] software). The manufacturer of the application software will determine specific indications for use. These third-party software packages or complete systems are approved separately from a regulatory perspective.

The digitizers are marketed as a component to application software development companies, who will incorporate the digitizer into their respective PACS or Teleradiology, CAD system(s). The software developer is ultimately responsible for detailing the Contraindications for the PACS System (or Teleradiology software package) or Oncology Systems as a whole, including the digitizer.



365 Herndon Parkway
Herndon, VA 20170 U.S.A.

Phone: 1-703-471-7070
Fax: 1-703-471-7665
Internet: www.filmdigitizer.com

Sales: 1-800-471-SCAN or
1-800-471-7226
Email: sales@VIDAR.com

Technical Support:
1-800-471-SCAN or 1-703-471-7070
E-mail: medtech@VIDAR.com



Emergo Europe
Molenstraat15
2513 BH, The Hague
The Netherlands

Phone: +31 (0) 70.345.8570
Fax: +31 (0) 70.346.7299
E-mail: service@emergogroup.com

Caution: No operator-serviceable parts inside. Refer servicing to qualified personnel.
Achtung: Gehäuse nicht öffnen. Wartung und Reparatur nur durch Elektrofachkräfte.
Attention: Aucune pièce ne peut être remplacée par l'utilisateur. Toute opération de maintenance doit être effectuée par une personne qualifiée.
Atencion: Acceso interno solo autorizado a personal técnico cualificado.
Attenzione: Non aprire. Rivolgersi a personale qualificato.

Radio Frequency Emissions

This equipment has been tested and found to comply with the limits for a Class A digital device, pursuant to Part 15 of the FCC Rules. These limits are designed to provide reasonable protection against harmful interference when the equipment is operated in a commercial environment. This equipment generates, uses, and can radiate radio frequency energy and, if not installed and used in accordance with the instruction manual, may cause harmful interference to radio communications. Operation of this equipment in a residential area can cause harmful interference, in which case the user will be required to correct the interference at his or her own expense.

Product compliance testing was conducted using VIDAR shielded cables. Modifications to the digitizer or the VIDAR shielded cables or the use of cables other than those available from VIDAR could void the user's authority to operate the equipment.

Acceptable shipping conditions

- Temperature: -18° to $+60^{\circ}\text{C}$ (0° to $+140^{\circ}\text{F}$)
- Relative humidity: 20% to 85%, non-condensing
- Atmospheric pressure: 500 to 1060hPa (+18,000 to $-1,200\text{ft}$)

Operating conditions

- Temperature: 10°C to 35°C (60°F to 95°F)
- Relative humidity: 20% to 85%, non-condensing
- Atmospheric pressure: 696 to 1013hPa (10,000 to 0 ft)

Electrical supply

- Voltage: 100 to 240 VAC
- Current: 0.75 to 1.5 A
- Frequency: 47 to 63 Hz

Safety and compliance information



MEDICAL –GENERAL MEDICAL EQUIPMENT AS TO ELECTRIC SHOCK, FIRE AND MECHANICAL HAZARDS ONLY IN ACCORDANCE WITH: CAN/CSA C22.2 No.601.1-M90, IEC 60601-1, UL 60601-1, ANSI/AAMI ES60601-1(2005, 3RD Ed.), CAN/CSA-C22.2 No.60601-1(2008). IEC 60601-1:2005(3RD Ed.).

Accessory equipment connected to the analog and digital interfaces must be certified according to the respective IEC standards (i.e. IEC 60950 for data processing equipment and IEC 60601-1 for medical equipment). Furthermore all configurations shall comply with the system standard IEC 60601-1-1 or IEC 60601-1 3rd edition.

Everybody who connects additional equipment to the signal input part or signal output part configures a medical system, and is therefore responsible that the system complies with the requirements of IEC 60606-1-1 or IEC 60601-1 3rd edition. If in doubt, consult the technical services department or your local representative.

This product is rated for continuous use.

This product is in the Ordinary Equipment Class. It provides no protection against the ingress of water.

This product is not suitable for use in the presence of flammable anesthetic mixtures with air or with oxygen or with nitrous oxide.

Class I Medical Device; No Applied Parts. This product provides Class I medical device protection against electrical shock.

WARNING: To avoid the risk of electric shock, this equipment must only be connected to a supply mains with protective earth.

Grounding reliability can only be achieved when the equipment is connected to an equivalent receptacle marked “HOSPITAL ONLY” or “HOSPITAL GRADE”.

WARNING: Do not modify this equipment without authorization of the manufacturer.

Do not position the product so that it is difficult to disconnect the product from the Mains Power Supply.

Mains power may be removed from the product by disconnecting the power cable at the rear of the product. The Mains power may also be disconnected by unplugging the power cord from the external power supply adapter or unplugging the power cord from the wall outlet.

Power cords used with this device in North America must be rated by Underwriters Laboratories for hospital use.

Power cords used with this device in Europe must meet the requirements of IEC 227 Designation 53 or IEC 245 Designation 53.

Correct and safe operation of the digitizer requires familiarity with information that is not marked on the product. The following symbol indicates the operator should consult the manual for additional information:



This Class 1 LED device is safe under reasonably foreseeable conditions of operation.

The LED illumination system consists of 20 Class 1 LEDs, a mirror system to spread the light, and a diffuser to distribute the light approximately uniformly across an area of 2.4 sq in (15.5 sq cm). Light from the LED illuminator may be indirectly observed in the digitizer’s film entry and exit areas.

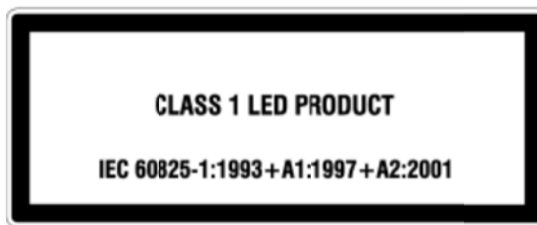

Contents

Intended Use	6
Operating	7
Apply power	7
About films	8
Using the multi-film feeder	9
Digitizing films longer than 17"	11
Setting up films longer than 17".....	11
Handling films over 17".....	13
Converting back for standard films.....	13
Troubleshooting	15
Normal operation	15
Power adapter information	15
In case of difficulty	16
Error conditions	16
Operational problems.....	17
Turning the digitizer on and off.....	19
Cleaning and maintaining	20
Maintenance Frequency	20
Cleaning the multi-film feed tray.....	20
Cleaning the diffuser.....	21
Replacing the LED cartridge	25
Appendix: Electromagnetic guidance	26
Appendix: Patient Vicinity	30
Appendix: Symbols	31

Intended Use

The DiagnosticPRO *Edge* digitizer is used for making digital copies of medical x-ray film, including printed and radiographic film. The target users of these devices are medical professionals or trained staff for use as secondary capture images for consultation, review and final interpretation.

The devices are indicated for the digitization of mammography images for review and analysis, but not as the sole basis for screening or diagnosis.

Note:

- The DiagnosticPRO *Edge* with ClinicalExpress or other DICOM standard software meets or exceeds ACR and DICOM standards for use of secondary capture images for consultation, review and final interpretation. Images captured as DICOM MG are to be used as reference or comparison only, and not for primary diagnosis.

Operating

the DiagnosticPRO *Edge* film digitizer

Apply power

If the film digitizer is already on and ready to scan (LED on the front of the digitizer is solid green), then skip this section.

1. Ensure the PC is turned **off**.

Note: Always apply power to the digitizer before turning on the computer. This enables the computer to recognize the digitizer.

2. Turn on the digitizer (the switch is located front of the digitizer body).



To turn digitizer ON:
Press and release power switch.
To turn digitizer OFF:
Press and hold for two seconds.

3. Observe the LED on the front of the digitizer: the LED should flash light blue for several minutes. This indicates the digitizer is performing internal tests and calibration.
4. When the LED stops flashing and remains solid green, turn on the PC and launch your scanning software.

The digitizer is now ready to scan films.

CAUTION: X-ray images displayed on a computer monitor are representative only. Dimensional and grayscale inaccuracies may result from the build-up of tolerances in the digitizer, the display board and the computer. For this reason, special precautions must be exercised when taking measurements from the digitized image. Please refer to the user's manual for your digitizing software for more information.

About films

The DiagnosticPRO *Edge* handles standard radiograph films up to 14" x 17" (35.5cm x 43cm). Longer films can be digitized, however this is dependent on the software, and films longer than 17" must be fed manually and supported during digitization.

With multi-film DiagnosticPRO *Edges*, you can feed multiple films (up to 25), and you can mix film sizes ranging from 8" x 10" (20.5cm x 24.5cm) to 14" x 17" (35.5cm x 43cm) in one stack—as long as you follow the rules below.

IMPORTANT: Remove stickers, tape, staples, paper clips, etc. from films before scanning. These may cause serious film feeding problems. Failure to remove extraneous items from films will void your warranty.

Load films just as you would view them on a light box, with these qualifications:

- Films 8" x 10" (20.5cm x 24.5cm) or larger should be fed in portrait orientation, as shown here. _____
- Films smaller than 8" x 10" (20.5cm x 24.5cm) must be fed one at a time.
- Proper orientation of the film during loading depends on the scanning application program you are using. Some scanning programs rotate images 180° for display. If images appear upside down, you may be able to set the default orientation in the scanning application. If this option isn't available, then insert films into the digitizer upside down, as shown here. _____

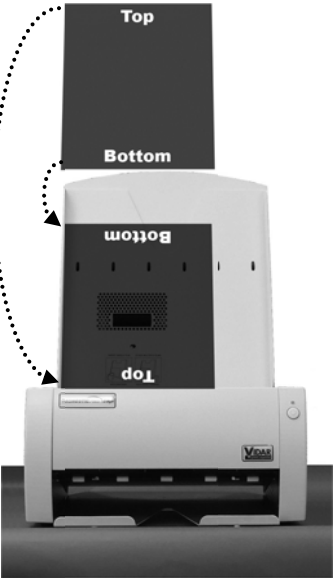
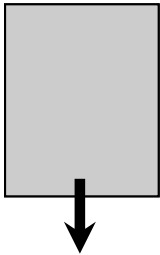

Using the multi-film feeder

The DiagnosticPRO *Edge* with multi-film feeder can accept stacks of **up to 25** films of mixed sizes. It can also accept single films.

Note: The digitizer cannot scan films smaller than 5" x 7" (12.7cm x 17.8cm). When loading small films, the vertical dimension must be at least 7" (17.8cm).

CAUTION: Do not load more than 25 films at one time.

1. Ensure the LED on the front of the digitizer is solid green.
2. Hold the film stack (or single film) in front of you as you would view the films on a light box.

Films at the back of the stack are digitized first.

3. Align the left edge of the film stack with the film guide on the left edge of the feeder.
4. Place the film stack in **the door's film loading channel**.

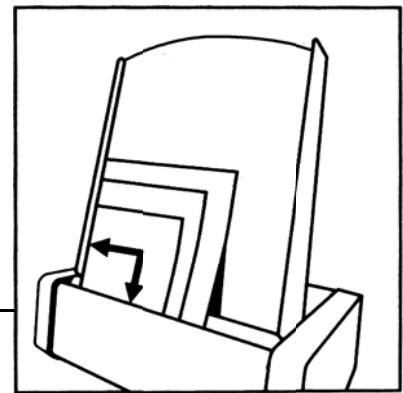

The film loading channel is along the top of the digitizer's door in front of the feed tray.

Note: If you are digitizing a **single** film, place the film either in the door film loading channel (as you would for a stack of films), or insert the film directly into the digitizer, depending on the instructions from your scanning application. If no instructions are given, place the film in the door's film loading channel.

Note: When a film has been staged, it is in the digitizer's light path. The ADC (Automatic Digitizer Calibration) feature requires that the light path be clear of the film for proper background calibration of the digitizer. The digitizer will automatically adjust the film's position to properly proceed with ADC. Depending on the location of the film's leading or trailing edge, and the length of time the film has been blocking the light path, the film will be: a) pushed up, b) pushed down, or c) ejected to remove the film from the light path.

5. Using your scanning software, execute the **Digitize** or **Scan** command.
The LED will flash green rapidly, indicating the first scan is in progress.
When the first scan is complete, the second film will be scanned and so forth, until the last film has been scanned.
When the entire batch has been scanned, the LED will return to solid green.

Note: After the scan, the last film may or may not be ejected—your scanning software determines what happens. If the software's **Auto Eject** function is activated, the film will drop into the exit tray. Otherwise, the lower rollers in the digitizer will hold the film until one of the following occurs:

- Another film is detected.
- You manually eject the film from the software.
- The ADC process begins by ejecting the film.

Digitizing films longer than 17”

With the DiagnosticPRO *Edge* film digitizer

Setting up films longer than 17”

1. Remove the exit tray:
 - a. Lift the exit tray up to disconnect it from the internal pins.
 - b. Pull the exit tray out from the digitizer.

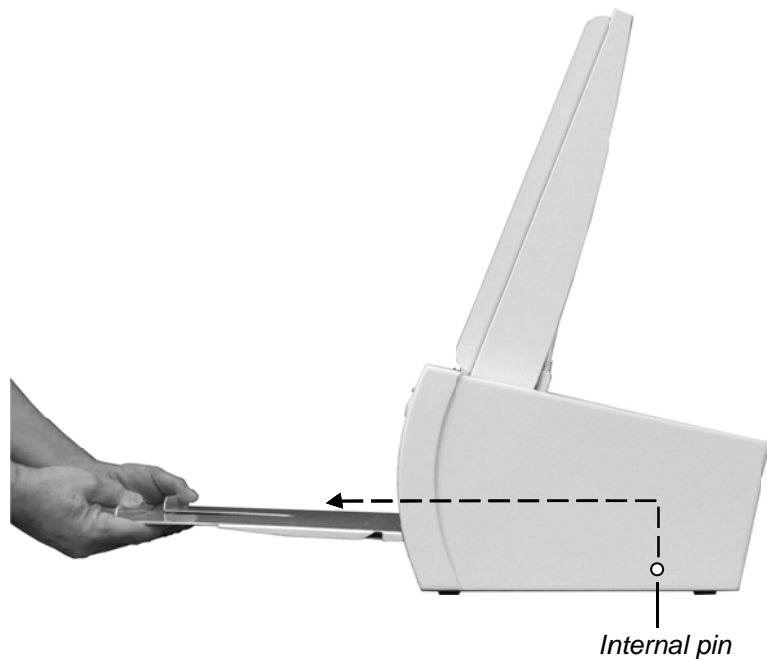

2. Move the film deflector:

- a. Pull the film deflector forward and hold it...

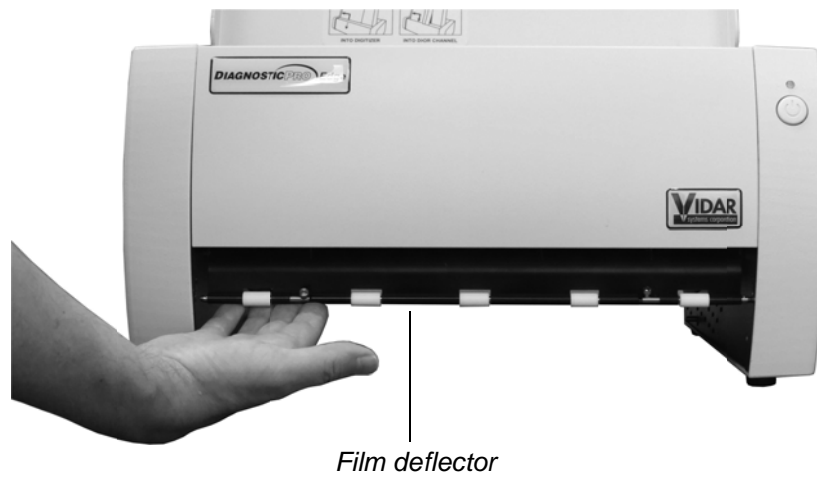

- b. while you slide the two retainers (one on each side) to hold the film deflector in place.

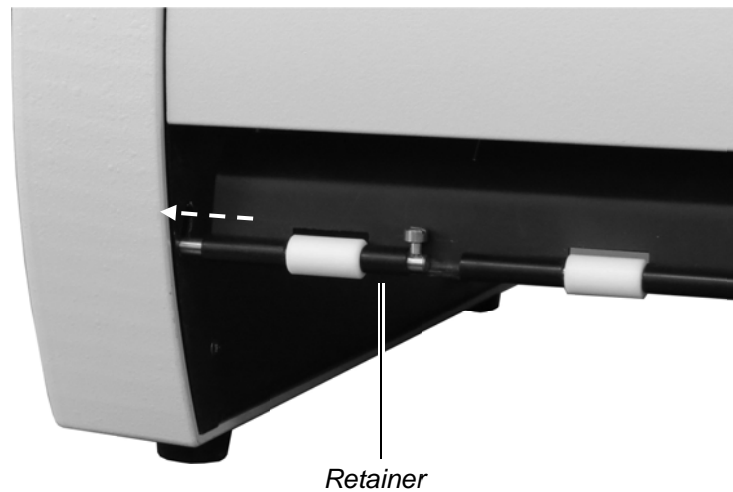

When the film deflector is in this position, long films can be directed (with your help) out toward the front of the digitizer.

3. Position the digitizer with its front near the edge of the table if you want films to exit off the edge of the counter. Otherwise, position the digitizer so films will exit onto the table.

Handling films over 17”

Feed longer films one at a time.

When feeding long films, you may need to support them as they are pulled into the digitizer.

As a film exits the digitizer, use your hand to direct the film toward the front of the digitizer.



Converting back for standard films

1. Hold the film deflector while you slide the two retainers (one on each side) toward the center.

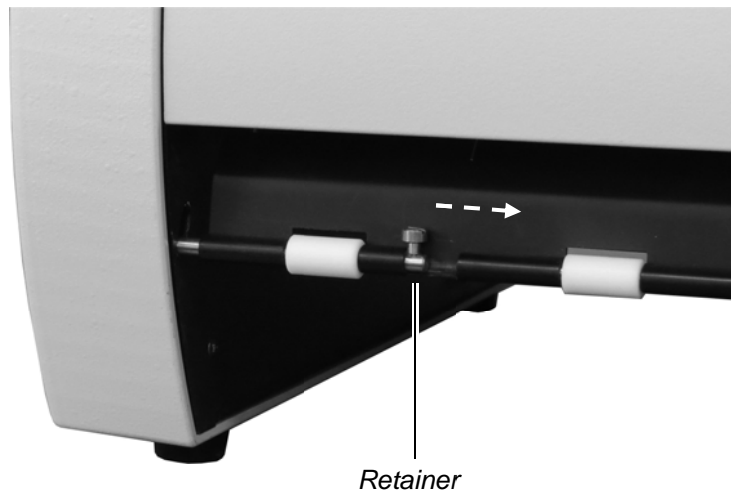

2. Allow the film deflector to return to its normal position.

When the film deflector is in this position, films leaving the digitizer are directed into the exit tray.

- Slide the exit tray into the digitizer, keeping it high, then drop it down and slide it back toward you so the notches fit over the internal pins.

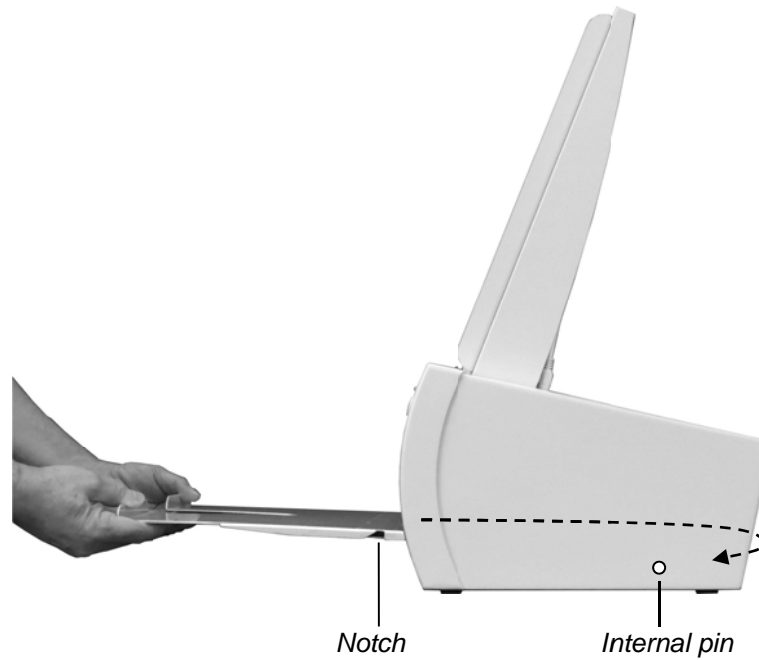

- When properly positioned, the exit tray will protrude a small distance from the digitizer, and it can't be pulled out without lifting it off the internal pins.

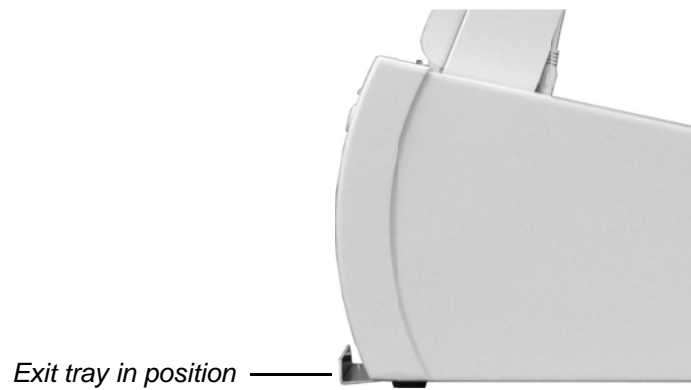

Troubleshooting

the DiagnosticPRO *Edge* film digitizer

Normal operation

LED indication	Condition
Flashing light blue	Digitizer calibrating, please wait.
Flashing amber	See “Error conditions” in the “In case of difficulty” section, later in this chapter.
Solid green	Ready to scan.
Flashing green	Scan in progress.

Power adapter information

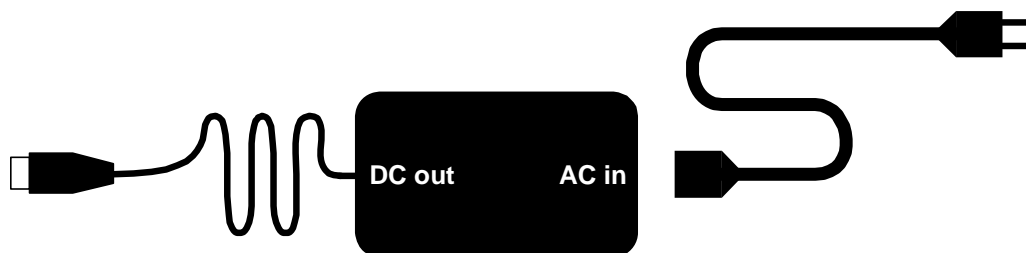

CAUTION: Power the digitizer **only** with the power supply adapter provided by your Service Provider or Vidar Systems Corp.

In case of difficulty

How to use this section:

1. Look through the left columns to find a description of the problem you are having.
2. Follow the instructions (in order) in the “Corrective action” column. If the one corrective action doesn’t solve the problem, then carry out the next corrective action.
3. When the instruction is “Get qualified technical help,” then:
 - a. Contact your system integration specialist (the company or person that installed your VIDAR film digitizer).
 - b. If your system integration specialist isn’t available, then contact VIDAR Customer Support (medtech@vidar.com). Please record system serial number before calling, and have it available when calling.

Tip: Check www.vidar.com for current troubleshooting information, tools and software updates.

Error conditions

LED indication	Condition	Corrective action
Flashing amber.	Normalization error.	1. Clean lamp diffuser (see “Cleaning the diffuser” in the “Cleaning and maintaining” chapter, later in this manual). <i>or if that doesn’t solve the problem...</i> 2. Replace lamp (instructions are provided with the Lamp Cartridge Replacement Kit). <i>or if that doesn’t solve the problem...</i> 3. Get qualified technical help.
No LED...	and digitizer functions correctly.	Get qualified technical help.
No LED...	and digitizer does not function.	1. Ensure that power cable is properly plugged into digitizer (power cable connects to rear of digitizer). If digitizer then appears normal, wait for solid green LED, then reboot PC. <i>or if that doesn’t solve the problem...</i> 2. Ensure that electrical power cord is properly plugged into power adapter. If digitizer then appears normal, wait for solid green LED, then reboot PC. <i>or if that doesn’t solve the problem...</i> 3. Get qualified technical help.

continued

Operational problems

Symptom	Corrective action
Film tilts or skews during scanning.	<ol style="list-style-type: none"> 1. Ensure individual films are loaded properly: bottom edge of film parallel to rollers, left edge of film up against digitizer body—as far left as it will go. (Review “Loading a single film” in “Operating” chapter.) 2. (<i>Multi-film feeder only</i>) Ensure multiple films are loaded properly: place films in front of blue area. 3. Ensure pickup roller is clean (see “Cleaning the multi-film feed tray,” later in this chapter). 4. Ensure idler rollers in multi-film feeder spin freely. 5. If problem persists, get qualified technical help. 6. Remove any foreign matter from film entrance slot.
After film is loaded and staged properly, a few minutes later film is pushed out of staging area.	When film is staged, it is over digitizer's light path. DiagnosticPRO's ADC (Automatic Digitizer Calibration) feature requires that light path be clear for proper background calibration. Thus, if film remains in digitizer for more than 5 minutes, it will be pushed up 1/4" (0.6cm) to clear light path. Later, when you execute your software's Scan command, film will be re-staged before it is digitized.
Digitizer has been off for several days. First film misfeeds or jams.	Run three or four films through digitizer: load films one at a time, then eject each one (or perform a scan on each film, but this takes longer).
Multi-film feed tray won't feed films.	The multi-film feed tray must be connected to the digitizer with the multi-film feed tray cable. The cable is located above the digitizer body, on the left side (when viewed from the front). Ensure the cable is present. Ensure one end of the cable is plugged into the jack on the multi-film feed tray, and the other end is plugged into the digitizer. After checking cable and connections, restart digitizer, then restart PC after LED turns green.
After applying power, LED on front keeps flashing light blue.	After power is applied, digitizer normally requires about 7 minutes to normalize and calibrate, during which time the LED will flash light blue. If LED flashes light blue for more than 15 minutes, turn digitizer power off and on again (as described later in this chapter), then reboot PC.
Solid Amber or white LED on front	Hardware failure during normalization. Please contact qualified technical assistance.
Streaks in image	Clean LED cartridge diffuser (see “Cleaning the diffuser” in the “Cleaning and maintaining” chapter, later in this manual).

continued

Symptom	Corrective action
LED is off, in spite of using proper power-on procedure described later in this chapter.	<ol style="list-style-type: none"> 1. Ensure wall outlet is providing AC power: obtain another electrical device known to be working, and plug it into that AC wall outlet. <ul style="list-style-type: none"> ■ If other device doesn't work, AC power is not available at that wall outlet. Get help from building services. ■ If other device does work, AC power is available from that outlet. Go to step 2. 2. With power applied to digitizer, look into digitizer film entrance slot. If you see light coming from inside digitizer, power is on. For this condition (LED off, internal light on), get qualified technical help. 3. If you have another DiagnosticPRO <i>Edge</i> film digitizer, try its power adapter. <ul style="list-style-type: none"> ■ If digitizer works with other power adapter, original power adapter is defective. Obtain replacement <u>VIDAR DiagnosticPRO <i>Edge</i></u> power adapter from your system integration specialist. DiagnosticPRO <i>Edge</i> film digitizers with serial numbers 380,000 through 389,999 require VIDAR part number 40360-001. Do not substitute any other power adapter. ■ If digitizer does not work with a known good power adapter, get qualified technical help. <p>CAUTION: Using a non-approved power adapter will void the warranty.</p>

Film starts and stops during scanning.	<ol style="list-style-type: none"> 1. Increase memory allocation for scanning software. (Especially if scanning at high resolutions, memory allocation must be sufficient to accept data stream from digitizer.) 2. If scanning to disk, ensure sufficient space is available on disk drive. 3. Ensure PC has enough memory available to support scanning application. Close applications not needed for image acquisition from digitizer. 4. If problem persists, get qualified technical help.
--	--

Digitizer stops scanning and PC locks up.	<ol style="list-style-type: none"> 1. Reset entire system. <ol style="list-style-type: none"> a. Turn digitizer off. b. Shut down PC and turn it off. c. Turn digitizer on. d. After digitizer LED turns solid green, turn on PC. 2. Launch scanning software on PC, then try scanning again. If problem persists, get qualified technical help. 3. Check for correct device driver installation.
---	---

Digitizer is not listed in Windows Control Panel > Scanners and Cameras. or Demoscan does not work.	<ol style="list-style-type: none"> 1. Update to or reinstall VIDAR drivers. See the "Install device drivers and toolkit" chapter of the "Installation Guide for DiagnosticPRO <i>Edge</i>." 2. Check all USB cables and connectors.
---	---

continued

Turning the digitizer on and off

WARNING

Do not apply power by plugging the DC power connector into the digitizer while the power adapter is live. Do not remove power by unplugging the DC power connector from the digitizer while the power adapter is live. Either of these actions could permanently damage the digitizer, the power adapter or both.

Note: DiagnosticPRO *Edge* was designed to be powered continuously. Under normal conditions, the digitizer should remain on at all times.

Use only the power switch to turn the digitizer on or turn it off:

The power switch is located on the front of the digitizer.



To turn digitizer ON:
Press and release power switch.
To turn digitizer OFF:
Press and hold for two seconds.

Cleaning and maintaining

the DiagnosticPRO *Edge* film digitizer

Maintenance Frequency

The DiagnosticPRO Edge should be maintained as needed.

Cleaning the multi-film feed tray

After extensive use, dust or lint particles may build up on the feed roller and idler wheels.



To remove residue, loop a piece of light adhesive tape (such as Scotch® Magic™ Tape) around your fingers with the adhesive side out, then gently pat the roller and wheels as you turn them.

CAUTION:

- **Do not** use any type of cleaning solvent on the feed roller and idler wheels, as this could damage these components and cause improper operation.
- **Do not** use tape with a strong adhesive, such as packing tape or strapping tape.
- **Do not** use tape requiring the adhesive to be wetted, such as brown paper packing tape.

Cleaning the diffuser

Note: Use this procedure only when you observe streaks in images, or when the digitizer's LED flashes amber.

Note: Use this procedure only for DiagnosticPRO *Edge* digitizers with serial numbers between 380,000 and 389,999.

IMPORTANT: You must follow these instructions when cleaning the diffuser. Deviation from these instructions will void the product's warranty and will likely result in costly repairs.

You will need:

- Lint-free wipes (VIDAR part number 15194).

1. Shut down the system:

- a. Shut down and turn off the PC.
- b. Turn off the digitizer using the power switch on the front panel: press and hold for two seconds.



- c. Disconnect the power cable and USB cable from the rear of the digitizer.

2. Open the front panel by pulling its top edge.

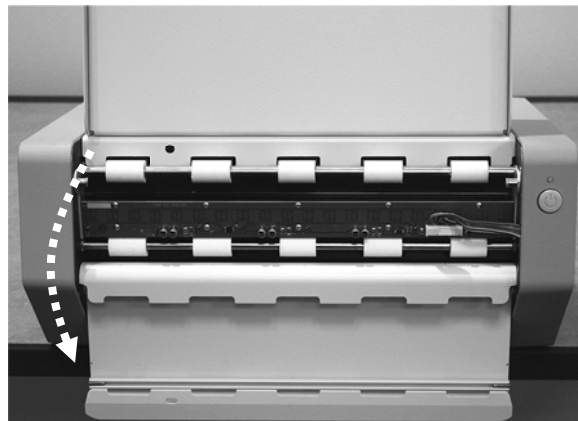

3. Disconnect the cable: press the top of the latch, then pull the connector up out of the jack.

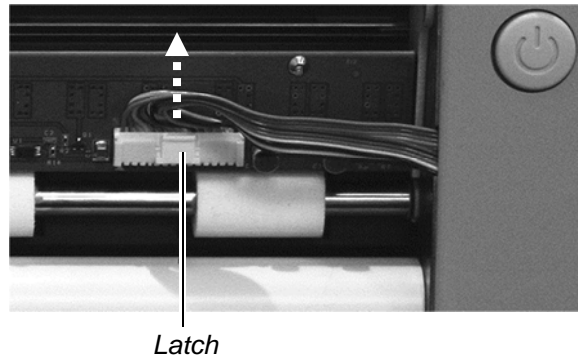

4. Loosen 2 captive screws securing the LED Bar (fingers work fine, but using a screwdriver is okay).

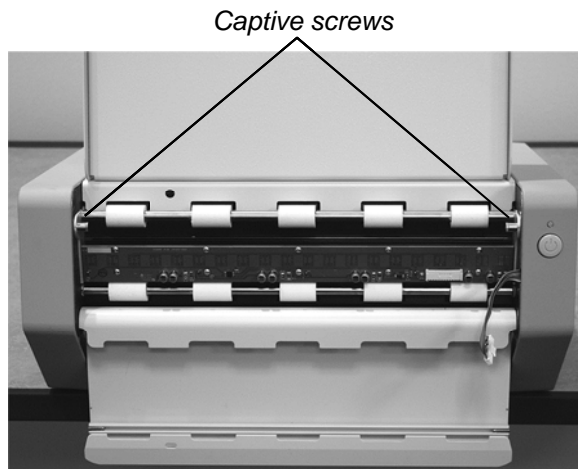

5. Remove the LED cartridge: grasp the cartridge at both ends, pull it slightly toward you, then slide it up out of the chassis.



6. Clean the diffuser: using a lint-free wipe, clean the entire length of the diffuser (white plastic strip) on the LED cartridge.

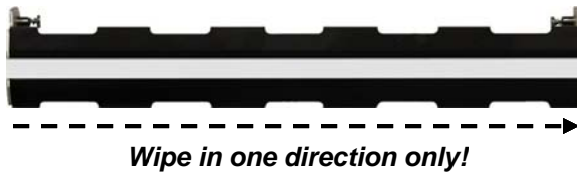

CAUTION: Clean only with lint-free wipes provided by VIDAR (part number 15194). Other cloth or paper wipes will leave fibers on the diffuser, which can affect performance. DO NOT USE ALCOHOL or other solvents as they may degrade the diffuser and void your warranty.

7. Reinstall the LED cartridge: slide the cartridge down into the chassis until it rests on two pins, then rotate it away from you until it doesn't move farther back.

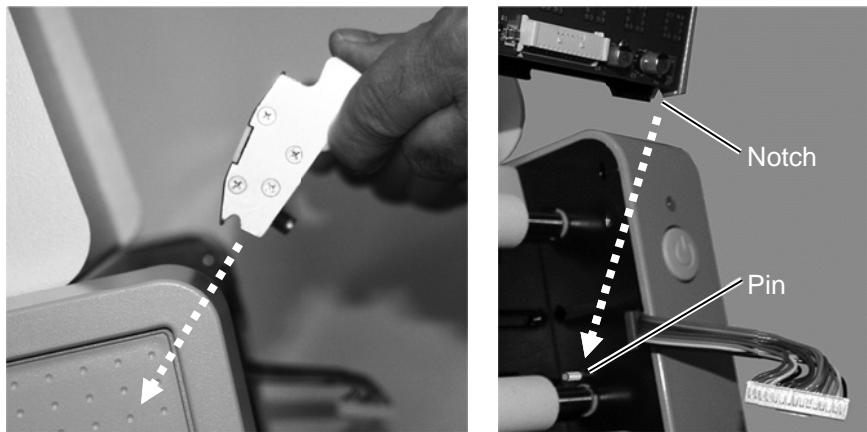

8. Tighten 2 captive screws.

LED Bar properly seated

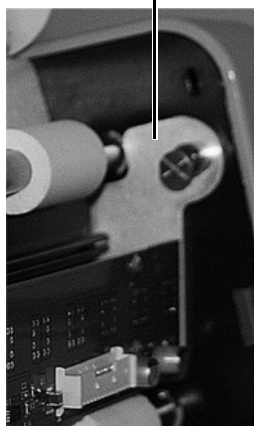

Captive screws

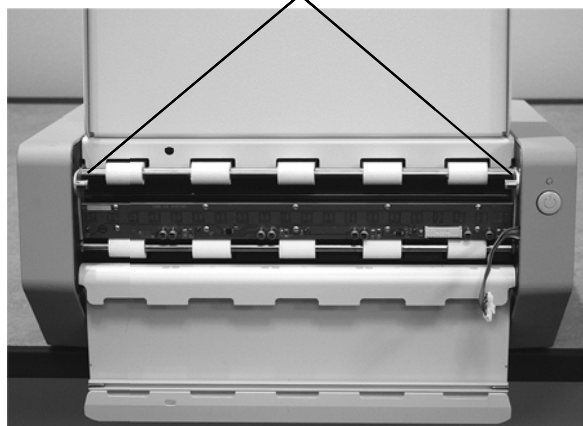

9. Plug the cable into the jack.

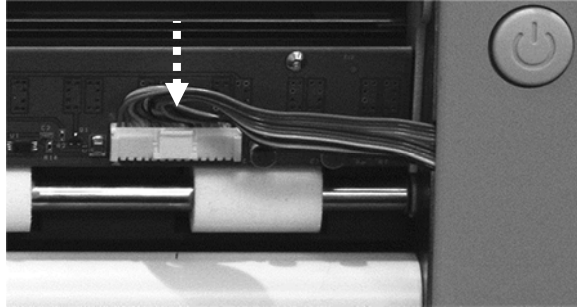

10. Close the front panel.

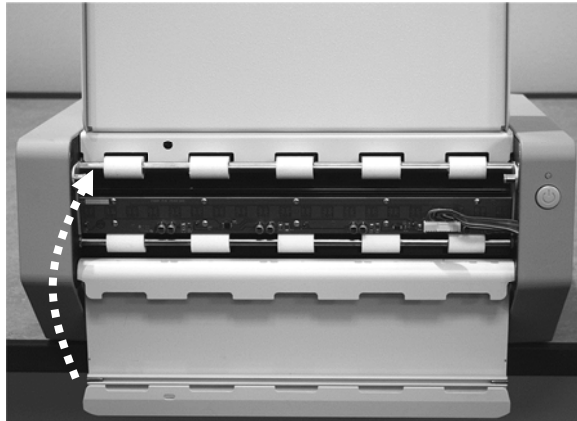

11. Power up the system:

- a. Assure the PC is off.
- b. Plug the USB cable and power cable into the jacks on the rear of the digitizer.
- c. Turn on the digitizer: press and release the power switch on the front panel.
- d. Observe the LED on the front of the digitizer. It should flash light blue for several minutes (indicating the digitizer is performing internal tests and calibration).
- e. When the LED stops flashing and remains green, turn on the PC.

The digitizer is now ready to scan films.

Replacing the LED cartridge

Note: LED cartridges can only be replaced on DiagnosticPRO *Edge* digitizers with serial numbers between 380,000 and 389,999.

Please contact VIDAR Technical Support to order the Lamp Cartridge Replacement Kit, VIDAR part number 19310-XXX:

- Phone: 1-800-471-SCAN (1-800-471-7226)
1-703-471-7070 outside the U.S.A.
- E-mail: medtech@vidar.com

Instructions for replacing the LED cartridge are provided with the kit.

Appendix:

Electromagnetic guidance

<p>Caution: Medical electrical equipment. EMC (Electro Magnetic Compatibility) must be considered before any medical electrical equipment is installed or put into service. Follow the information in the accompanying documentation when installing and operating the DiagnosticPRO <i>Edge</i> Digitizer.</p>
<p>Caution: Portable or mobile RF communication equipment can effect Medical Electrical equipment.</p>
<p>Caution: Using the Digitizer adjacent to or stacked with other equipment may cause interference between the equipment. Before utilizing stacked or adjacent equipment, verify proper functionality of all equipment in the actual configuration in which it will operate.</p>
<p>Caution: Connecting the Digitizer to equipment that is not rated CISPR 11 class A or class B may alter the electromagnetic characteristics.</p>
<p>Caution: In a domestic environment this product may cause radio interference in which case the user may be required to take adequate measures.</p>

Guidance and manufacturer's declaration – electromagnetic equipment

Table 201

The DiagnosticPRO *Edge* Digitizer is intended for use in the electromagnetic environment specified below. The customer or end user of the DiagnosticPRO *Edge* Digitizer should assure that it is used in such an environment.

Emissions test	Compliance	Electromagnetic environment - guidance
RF Emissions CISPR11	Group 1	The DiagnosticPRO <i>Edge</i> Digitizer uses RF energy only for its internal function. Therefore, its RF emissions are very low and are not likely to cause any interference in nearby electronic equipment.
RF Emissions, CISPR11	Class A	The DiagnosticPRO <i>Edge</i> Digitizer is suitable for use in all establishments other than domestic and those directly connected to the public low voltage power supply network that supplies buildings used for domestic purposes.
Harmonic Emissions IEC 61000-3-2	Class A	
Voltage Fluctuations/ flicker emissions IEC 61000-3-3	Complies	

Guidance and manufacturer's declaration – electromagnetic immunity

Table 202

The DiagnosticPRO *Edge* Digitizer is intended for use in the electromagnetic environment specified below. The customer or end user of the DiagnosticPRO *Edge* Digitizer should assure that it is used in such an environment.

Immunity test	IEC 60601 test level	Compliance level	Electromagnetic environment - guidance
ElectroStatic Discharge (ESD) IEC 61000-4-2	+ 6 kV contact + 8 kV air	+ 6 kV contact + 8 kV air	Floors should be wood, concrete or ceramic tile. If floors are covered with synthetic material, the relative humidity should be at least 30%
Electrical fast transient/burst IEC 61000-4-4	±2 kV for power supply lines ±1 kV for input/output lines	±2 kV for power supply lines ±1 kV for input/output lines	Mains power quality should be that of a typical commercial or hospital environment.
Surge IEC 61000-4-5	±1 kV differential mode ±2 kV common mode	±1 kV differential mode ±2 kV common mode	Mains power quality should be that of a typical commercial or hospital environment.
Voltage dips, short interruptions and voltage variations on power supply input lines IEC 61000-4-11	<5 % U_T (>95 % dip in U_T) for 0,5 cycle 40 % U_T (60 % dip in U_T) for 5 cycles 70 % U_T (30 % dip in U_T) for 25 cycles <5 % U_T (>95 % dip in U_T) for 5 sec	<5 % U_T (>95 % dip in U_T) for 0,5 cycle 40 % U_T (60 % dip in U_T) for 5 cycles 70 % U_T (30 % dip in U_T) for 25 cycles <5 % U_T (>95 % dip in U_T) for 5 sec	Mains power quality should be that of a typical commercial or hospital environment. If the user of the DiagnosticPRO <i>Edge</i> Digitizer requires continued operation during power mains interruptions, it is recommended that the DiagnosticPRO <i>Edge</i> Digitizer be powered from an uninterruptible power supply or a battery
Power frequency (50/60 Hz) magnetic field IEC 61000-4-8	3 A/m	3 A/m	Power frequency magnetic fields should be at levels characteristic of a typical location in a typical commercial or hospital environment.

NOTE: U_T is the A.C. mains voltage prior to application of the test level

Guidance and manufacturer's declaration – electromagnetic immunity

Table 204

The DiagnosticPRO *Edge* Digitizer is intended for use in the electromagnetic environment specified below. The customer or end user of the DiagnosticPRO *Edge* Digitizer should assure that it is used in such an environment.

Immunity test	IEC 60601 test level	Compliance level	Electromagnetic environment - guidance
Conducted RF IEC 61000-4-6	3 Vrms 150 kHz to 80 MHz	3 V	Portable and mobile RF communication equipment should be used no closer to any part of the DiagnosticPRO <i>Edge</i> Digitizer, including cables, than the recommended separation distance calculated from the equation applicable to the frequency of the transmitter. Recommended separation distance $d = 1.2\sqrt{P}$
Radiated RF IEC 61000-4-3	3 V/m 80 MHz to 2,5 GHz	3 V/m	
			$d = 1.2\sqrt{P}$ 80 MHz to 800 MHz $d = 2.3\sqrt{P}$ 800 MHz to 2.5 GHz Where P is the maximum output power rating of the transmitter in watts (W) according to the transmitter manufacturer and d is the recommended separation distance in meters (m). Field strengths from fixed RF transmitters, as determined by an electromagnetic site survey, ^a should be less than the compliance level in each frequency range. ^b Interference may occur in the vicinity of equipment marked with the following symbol: <div style="text-align: center;">  </div>

Note 1: At 80MHz and 800MHz, the higher frequency range applies.

Note 2: These guidelines may not be applicable in all situations. Electromagnetic propagation is affected by absorption and reflection from structures, objects and people.

^a Field strengths from fixed transmitters, such as base stations for radio (cellular/cordless) telephones and land mobile radios, amateur radio, AM and FM radio broadcast and TV broadcast cannot be predicted theoretically with accuracy. To assess the electromagnetic environment due to fixed RF transmitters, an electromagnetic site survey should be considered. If the measured field strength in the location in which the DiagnosticPRO *Edge* Digitizer is used exceeds the applicable RF compliance level above, the DiagnosticPRO *Edge* Digitizer should be observed to verify normal operation. If abnormal performance is observed, additional measures may be necessary, such as reorienting or relocating the Digitizer.

^b Over the frequency range 150 kHz to 80 MHz, field strengths should be less than 3 V/m.

Recommended separation distances between portable and mobile RF communications equipment and the DiagnosticPRO Edge Digitizer

Table 206

The DiagnosticPRO Edge Digitizer is intended for use in an electromagnetic environment in which radiated RF disturbances are controlled. The customer or the user of the DiagnosticPRO Edge Digitizer can help prevent electromagnetic interference by maintaining a minimum distance between portable and mobile RF communications equipment (transmitters) and the DiagnosticPRO Edge Digitizer as recommended below, according to the maximum output power of the communications equipment.

Rated maximum output power of transmitter W	Separation distance according to frequency of transmitter, m		
	150 kHz to 80 MHz $d = 1.2\sqrt{P}$	80 MHz to 800 MHz $d = 1.2\sqrt{P}$	800 MHz to 2.5 GHz $d = 2.3\sqrt{P}$
0.01	0.12	0.12	0.23
0.1	0.37	0.37	0.74
1	1.2	1.2	2.3
10	3.7	3.7	7.4
100	12	12	23

For transmitters rated at a maximum output power not listed above, the recommended separation distance d in meters (m) can be estimated using the equation applicable to the frequency of the transmitter, where P is the maximum output power rating of the transmitter in watts (W) according to the transmitter manufacturer.

NOTE 1: At 80 MHz and 800 MHz, the separation distance for the higher frequency range applies.

NOTE 2: These guidelines may not apply in all situations. Electromagnetic propagation is affected by absorption and reflection from structures, objects and people.

Appendix:



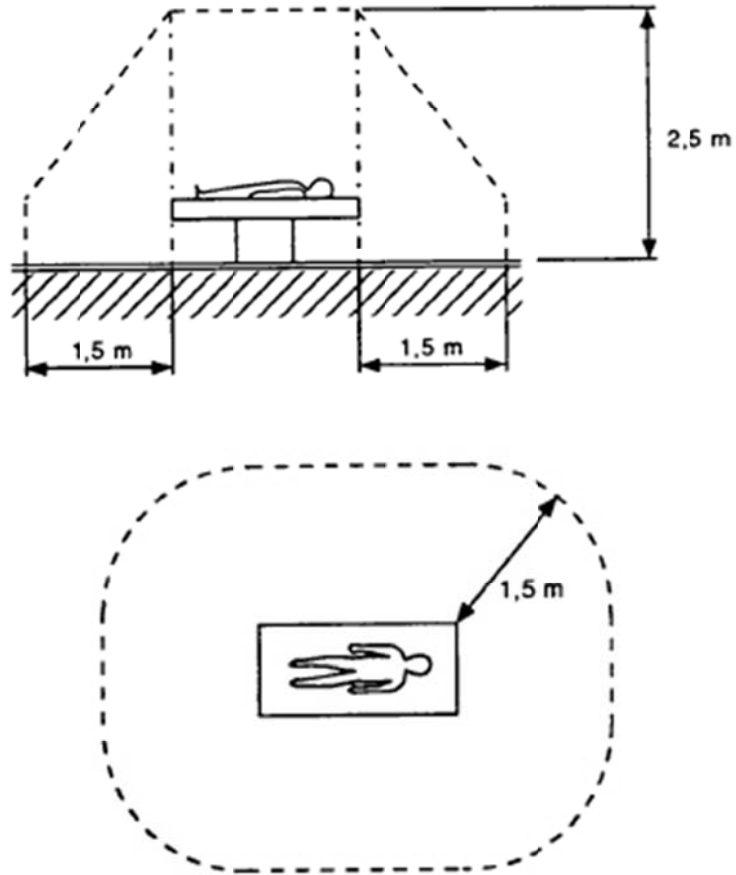





Patient Vicinity



Note: Dimensions shown are not prescriptive.

Appendix:

Symbols

Symbol	Description
	Indicates a sleep mode or low power state. The switch does not fully disconnect the device from its power supply.
	Indicates the need for the user to consult the instructions for use for important cautionary information such as warnings and precautions that cannot, for a variety of reasons, be presented on the medical device itself.
	Indicates the need for the user to consult the instructions for use.
	Underwriters Laboratories classification symbol
	Authorized Representative in the European Community
	Indicates the Medical Device Manufacturer
	Compliance to EU Directives
	This symbol on the product indicates that this product must not be disposed of as unsorted municipal waste. Instead it is your responsibility to dispose of your waste equipment by handing it over to a designated collection point for recycling of waste electrical and electronic equipment. For more information about where you can dispose of your waste equipment for recycling please contact your local city office, your household waste disposal service or the shop where you purchased the product.



**365 Herndon Parkway
Herndon, VA 20170 USA**

**Phone: 1-703-471-7070
Main fax: 1-703-471-1165
Web: www.filmdigitizer.com**

**Technical Support:
Phone: 1-703-471-7070
1-800-471-7226
Fax: 1-703-471-7665
E-mail: medtech@vidar.com**