

Overview

The ExpertPower LiFePO4 12V 10Ah rechargeable battery is optimized for low rate applications which require high energy density.

Features

- High energy density
- Automatic protection with internal battery management system
- Low self-discharge rate
- Long cycle life
- Excellent performance in all operating temperatures
- 4 batteries in series or parallel

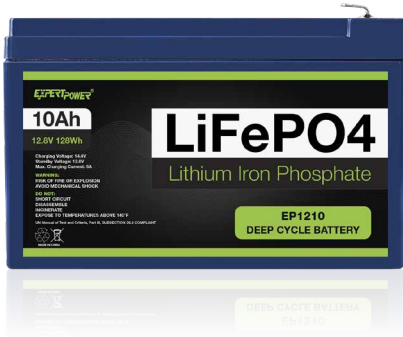

Battery Dimensions:

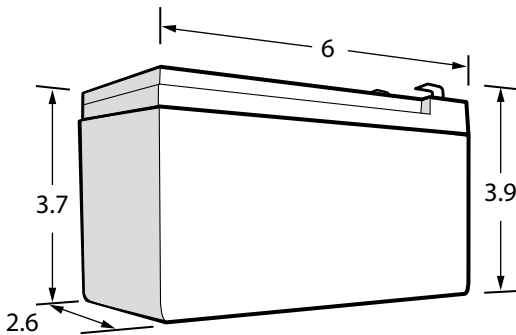

Battery Specifications:

Terminal Dimensions:

Top View

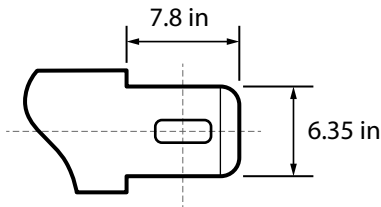

Side View

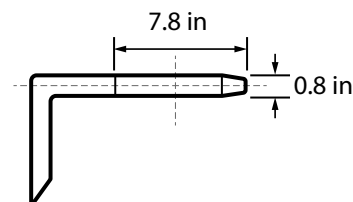

NOMINAL CHARACTERISTICS	
Nominal Voltage / V	12.8V
Nominal Capacity /Ah (77°F, 0.2C)	≥ 10Ah
MECHANICAL CHARACTERISTICS	
Weight	2.7 lbs
Dimensions L x W x H	6 x 2.6 x 3.7 in
BCI	-
Terminal	F2
ELECTRICAL CHARACTERISTICS	
Voltage Window	9.2 – 14.6V
Charge Voltage	14.4V
Standby Voltage	13.8V
Max. Continue Discharge Current	10A
Max. Permanent Discharge Current	15A 5Sec.
Recommend Max. Continue Charge Current	5A
OPERATION CONDITIONS	
Cycle Life (68°F 0.2C 100%DOD)	>2500 Cycles
Operating Temperature	Discharge: - 4 – 140°F Charge: 32 – 140°F
Storage Temperature	32 – 86°F
Storage Duration	12 Months at 77°F
Safety Standard	UL1642 at cell level

BMS Parameters

TYPE	FUNCTION	SETTING VALUE	RECOVERY
Over-Voltage	Cell Voltage Protection	$>3.65 \pm 0.05V$	Delay $1.0 \pm 0.5S$; Cell Voltage $\leq 3.5 \pm 0.1V$
Under-Voltage	Cell Voltage Protection	$<2.2 \pm 0.1V$	Delay $1.0 \pm 0.5S$; Cell Voltage $\geq 2.6 \pm 0.1V$
Over-Current	Over-Current Protection	$>30 \pm 5A$	Disconnect charger or load Auto recovery
	Delay	$1.0 \pm 0.2S$	
Temperature	Charge: $>167 \pm 9^{\circ}F$ or $<23 \pm 9^{\circ}F$		$<131 \pm 9^{\circ}F$ and $>41 \pm 9^{\circ}F$
	Discharge: $>167 \pm 9^{\circ}F$ or $<-4 \pm 9^{\circ}F$		$<131 \pm 9^{\circ}F$ and $>14 \pm 9^{\circ}F$
Cell Balance	Balancing Voltage		$3.6 \pm 0.1V$
	Balancing Current		$35 \pm 15mA$
Short Circuit		200uS - 1200uS	Disconnect load Auto recovery

Battery Attributes

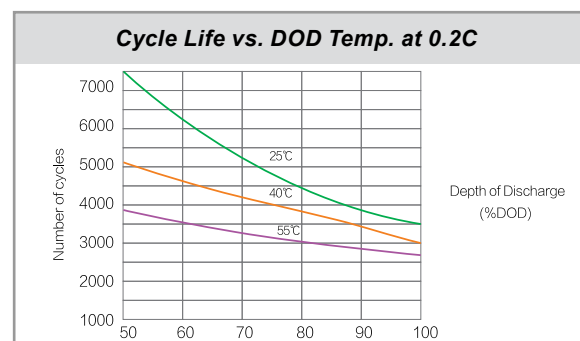
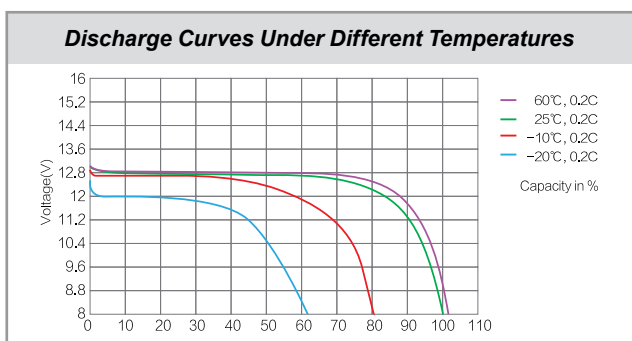

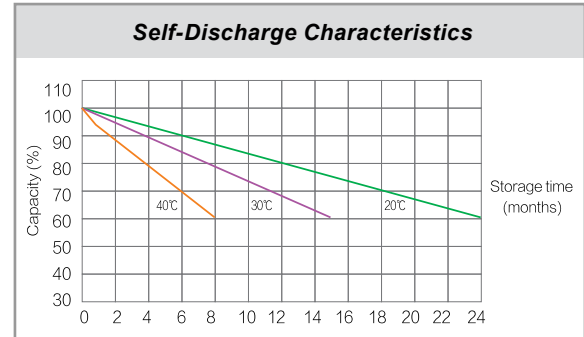
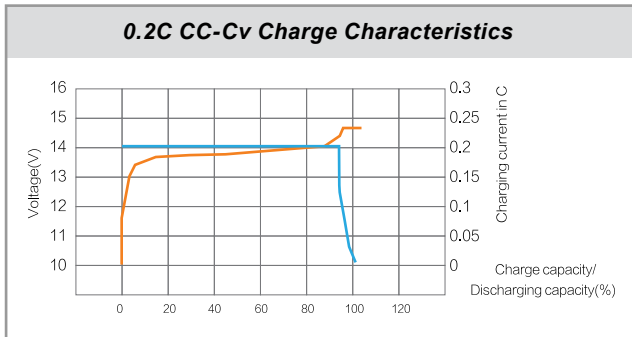

Series & Parallel Connection

Supports expansion up to 4 batteries sequenced in either series at 48V 10Ah, or in parallel at 12V 40Ah.

Wiring Considerations

During the wiring of sequenced batteries, it is imperative to adhere to the following guidelines to ensure optimal safety and performance:

- **Avoid Single Battery Connection:** Refrain from connecting both negative and positive wires from your electrical system to a single battery. Similarly, avoid linking them to batteries positioned centrally within the sequence.
- **Sequential Wiring Logic:** Whether arranging multiple batteries in parallel, it is crucial to wire your sequenced batteries in a manner where the negative and positive wires from your electrical system are attached to the battery bank via the first and last batteries respectively. To elucidate, the initial battery in your sequence should have its negative terminal connected to the negative wire of your system, while the final battery in the sequence should host the positive wire of your system linked to its positive terminal.

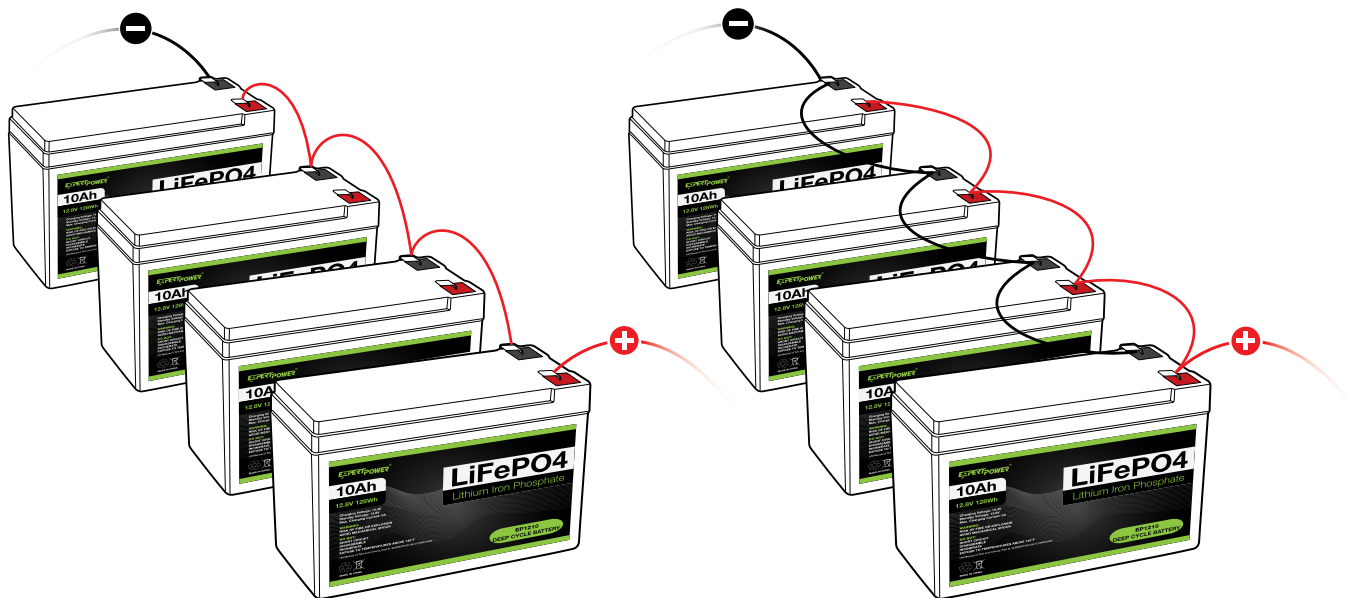

4 In Series - 48V 10Ah

4 In Parallel - 12V 40Ah

Caution

To ensure the utmost effectiveness and longevity of your battery configuration, adhere to these essential guidelines:

1. **Battery Consistency:** Utilize identical batteries for parallel or series connections.
2. **Uniform Voltage Levels:** Prior to connecting in parallel or series, guarantee that all batteries share the same voltage level by fully charging each individual battery. The permissible voltage difference is less than 0.2V.
3. **Avoid Mixing Batteries:** Do not combine old and new batteries within the same setup.
4. **Parallel and Series Separation:** Avoid simultaneous parallel and series connections for the batteries.
5. **Circuit Limitation:** Do not exceed connecting more than 4 batteries per circuit.
6. **Regular Maintenance:** Annually, the batteries should be individually charged after being detached from the series. Upon reassembly, the voltage difference should not exceed 0.5V.

Your compliance with these precautions ensures the reliability and longevity of your LiFePO4 rack mounted battery system.

Battery Charging

Efficiently charging LiFePO4 Batteries involves a precise 2-stage algorithm known as "Constant Current/Constant Voltage" (CC/CV). Following the standard LiFePO4 profile, the process entails a 0.2C Constant Current (CC) charge up to 14.2V, followed by Constant Voltage (CV) at 14.4V charge until the current reduces to $\leq 0.05C$.

For optimal results with a 10Ah LiFePO4 battery, we recommend adhering to these specifications:

- **Recommended Max Charging Current:** Ideally, the charging current should not exceed 5A (0.5C). However, when circumstances demand, a faster charge of 10A (1C) can be employed. Nonetheless, consistent usage of the 1C charge method may lead to reduced battery lifespan and capacity due to heightened heat generation during this process.

It's crucial to note that the utilization of chargers designed for other battery types, such as SLA and Gel chargers, is strongly discouraged. These chargers, tailored for acid-based chemistries, often come with features like desulfation, equalization, and float charging, which are detrimental to LiFePO4 batteries. The built-in BMS may not suffice to safeguard against the potential damage incurred from using such chargers.

The improper use of SLA chargers can trigger adverse effects:

- **Accelerated Aging:** Maintaining a LiFePO4 battery at 100% charge using the SLA float charging feature could significantly expedite the aging and degradation process due to the constant stimulation of battery cells.
- **Polarization and Electrolyte Decay:** The excess power supplied by an SLA charger can lead to material buildup at the electrode-electrolyte interface, known as polarization, and result in electrolyte decay.

Additionally, using an SLA charger with an OCV (Open-Circuit Voltage) detection setting might damage the battery and fail to revive an over-discharged LiFePO4 battery. The BMS will deactivate the battery for protection, resulting in a situation where the battery is seemingly in an open-circuit state.

To prevent these issues and ensure optimal battery performance:

- **Use Correct Charging Algorithm:** Employ the appropriate CC/CV algorithm (14.4V) for LiFePO4 batteries. SLA smart chargers lack the capability to fully charge or properly maintain LiFePO4 batteries.

Warnings

1. Do not immerse the battery in water or allow it to get wet.
2. Do not use or store the battery near sources of heat such as a fire or heater.
3. Do not reverse the positive (+) and negative (-) terminals.
4. Do not connect the battery directly to wall outlets or car cigarette-lighter sockets without proper charging equipment. Do not allow exposed ends of cables connected to opposite terminals to touch.
5. Do not put the battery into a fire or apply direct heat.
6. Do not use the battery if the battery casing has been pierced, broken, cracked, or otherwise visibly damaged. Do not forcibly open the battery casing for any reason.
7. Avoid severe physical shock. Do not throw the battery or heavily strike the battery in any way. Do not put excessive pressure or step on the battery.
8. Never solder anything directly to the battery terminals.
9. Do not attempt to disassemble or modify the battery in any way.
10. Do not place the battery in a microwave oven or pressurized container.

Usage and Storage

1. **Before Use Inspection:** Before employing the battery, conduct a thorough examination to ensure its integrity, free from visible damage or structural irregularities.
2. **Terminal and Other Visual Checks:** Do not utilize the battery if terminals are bent, broken, or if the battery exhibits any of the following conditions: abnormal heat, wetness, severe physical or water damage extending to the battery from the packaging, leaks, loose components, cracked casing, bloating, melting, heavy stress, or indentation. In such instances or if there are concerns about the battery's integrity, promptly contact our support team for expert assistance.
3. **Professional Installation:** For optimal performance and prevention of damage or malfunctions, it is strongly recommended to have these battery packs installed by a professional or experienced individual. Monitor charging and discharging during initial use, and diligently observe temperature and operational performance. Any operational issues should be directed to our support team.
4. **Proper Storage Conditions:** Store the battery pack in a well-ventilated, cool, and dry environment. Avoid stacking it under heavy objects, exposing it to high temperatures, open flames, or corrosive substances.
5. **Temperature and Humidity Considerations:** Store the battery within specified temperature conditions. Maintain a recommended humidity of 60±15%.
6. **Ideal Storage Capacity:** Store the battery at a capacity between 40% and 60%. Every three months during storage, follow these steps:
 - Fully charge the battery.
 - Discharge the battery completely.
 - Recharge the battery to a capacity between 40% and 60% to prevent over-discharge during storage.

Disclaimer

For your safety and the optimal functioning of your electrical system, we strongly advise engaging a qualified professional for installation. Properly handling electrical connections and components demands a comprehensive grasp of electrical principles and adherence to local building codes, along with appropriate installation techniques.

Employing a trained professional ensures accurate and secure installation, significantly reducing the risk of accidents and equipment damage.

Terms and Conditions

Prior to usage, carefully review all specifications, usage instructions, storage conditions, and warnings detailed in this document. Adherence to our handling and usage guidelines for this battery pack is paramount. Misuse of batteries can lead to malfunction, capacity reduction, degradation, overheating, explosion, or fire hazard. Responsibility for appropriate usage and storage, as outlined in this document, rests with the customers. If the battery exhibits excessive heat, leaks, malfunctions, visible damage, or fails to operate as expected, refrain from use and promptly contact our support team for assistance.

We disclaim responsibility for any damages resulting from the misuse of this battery, whether accidental or otherwise.

Warranty Information

This warranty guarantees that the batteries will be free from defects in materials and workmanship under normal use for a period of two years after purchase. However, it does not cover damages caused by customer abuse, improper handling, overcharging, undercharging, water damage, fire, or any other circumstances beyond our control. Furthermore, the warranty does not extend to normal wear and tear, capacity loss over time, or gradual decrease in battery performance.

Exclusions and Limitations

- Reasonable wear and tear.
- Normal corrosion.
- Use of unapproved parts or unapproved alterations to components to the extent prohibited by the manufacturer's written operating manuals.
- Defects caused by persons other than the manufacturer and its affiliates, including operation or maintenance of the product or installation and commissioning of the equipment and materials by such persons in violation of the written operating, maintenance, installation, and commissioning instructions, manuals, and protocols supplied to the buyer, or buyer's affiliates, by the manufacturer prior to such installation, commissioning or operation.
- Vandalism, misuse, or Force Majeure Events.
- Items expected to be consumed or expended during the normal and routine operation and maintenance of the product.
- Replacement of the product fulfills the one-time limited warranty during the stated period.

***Note on Customer Responsibilities**

Customers are responsible for proper maintenance and understanding the limitations of the product.

This includes:

1. Over-discharge from self-discharge during storage.
2. Improper use as a starting battery or in applications for which the product was not designed.
3. Opening or modifying the product.
4. Applying voltages/currents that are too high.
5. Improper storage.
6. Use of an undersized product.
7. Mechanical damage due to impact, excessive vibration, penetration, etc.
8. Damage due to connecting in reverse polarity.

9. Damage or resulting internal corrosion caused by liquids.
10. Use of an incorrect charger or charging profile.
11. Use of an appliance with built-in charging for a different battery chemistry.
12. Connecting the batteries to higher voltage or currents than supported, as stated in this document.

***For a full version of our product warranty please visit our website at:
<https://www.expertpower.us/pages/warranty-information> or scan the QR code below.**



**For Questions
And Support**

**Visit us at:
ExpertPower.us**

**(562) 630 - 3002
support@expertpower.us**

**6437 Alondra Blvd
Paramount, CA 90723**