

remo<sup>+</sup>

DoorCam™ 3

## Quick Start Guide

---

Name of the product : DoorCam™ 3

Model name : DC3U-2201

DC3U-2201-G



# WHAT'S IN THE BOX

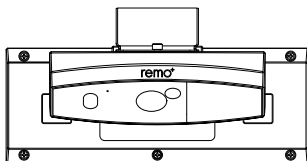

**DoorCam™ 3**



**Hex Wrench**

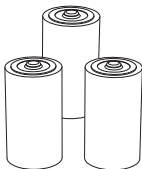

**3 D-Cell  
Alkaline Batteries**



**"Protected by remo+"  
Sticker**

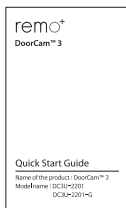

**Quick Start Guide**

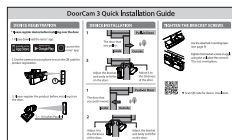

**Quick Installation Guide**

## MEET DOORCAM™ 3

- 1 Camera Lens
- 2 IR LED
- 3 ALS Sensor
- 4 Microphone
- 5 PIR Sensor
- 6 Speaker
- 7 Mounting Tape

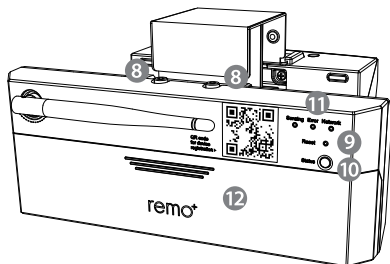
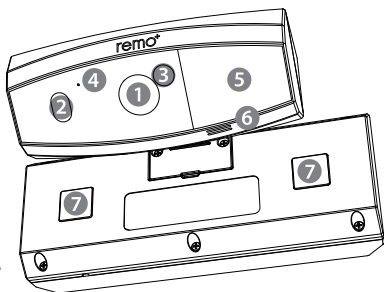

- 8 Body Bracket
- 8 Adjustment Screws
- 9 Reset Button
- 10 Status Button
- 11 Status LED
- 12 Battery Cover

## FULL TECHNICAL SPECIFICATIONS

**Power :** 3 D-Cell Alkaline Batteries or USB Power Supply (DC 5V 2A)

**Video :** Full HD, HD, VGA, Live View, Night Vision

**Audio :** Two-way audio

**Wireless Router :** IEEE 802.11 b/g/n 2.4GHz

**Operating Temperature :** 0° to 122°F (-18° to 50°C)

**Weather Resistance Rating :** IPX5

**Viewing Angle:** 150° (Diagonal)

**Dimensions :** Body 8.39×3.18×1.65 in. / Camera 5.9×2.17×2.15 in.

**Weight :** 1.2 lbs. (Without Batteries)

## DEVICE REGISTRATION

\* Please register device before installing over the door.

1. Please download the remo+ app.



2. Use the camera on your phone to scan the QR code for product registration.

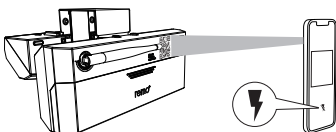

3. Please register the product before installing it on the door.

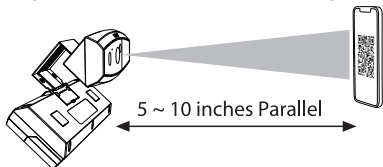

## DEVICE INSTALLATION

1

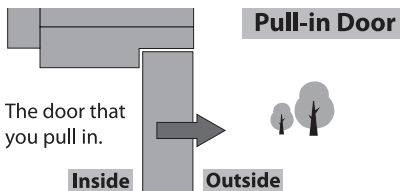

2

Adjust the bracket and body to fit flat on the door.

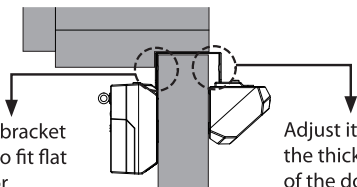

Adjust it to the thickness of the door.

1

The door that you push inward.

Inside

Outside

**Push-in Door**

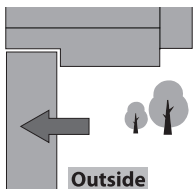

2

Adjust it to the thickness of the door.

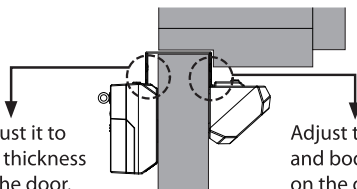

Adjust the bracket and body to fit flat on the door.

## TIGHTEN THE BRACKET SCREWS

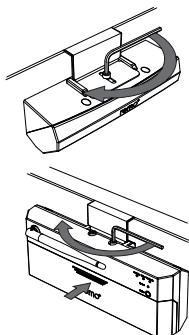

Use the attached mounting tape.  
(see page 9)

Tighten the bracket screws snugly  
using the included Hex wrench.  
\*Do not overtighten.

## CREATE AN ACCOUNT

1. Make sure your mobile device is connected to your home's 2.4GHz Wi-Fi (5GHz not supported).
2. Download the remo+ app.



Launch the remo+ app.



3. Click "Sign Up" at the bottom of the login page.



4. Enter your email and create a password. Then press "Sign Up". For Help, press the  at the top right corner. Once you have signed up, you are ready to register your device.

## REGISTER DOORCAM™ 3

1. Have your Wi-Fi network password available. Make sure the device you are using to register your DoorCam 3 is already connected to your 2.4 GHz Wi-Fi network before beginning the process (5 GHz network not supported).

*TIP: If you are using a smartphone, turn OFF your cellular data and connect to your home Wi-Fi network. You can also turn Airplane Mode ON and connect to your home Wi-Fi network.*

2. DoorCam 3 LED light should flash left and right.  If it does not, press the status button on the back of the device.

3. After login to the remo+ app, press "+" on the home screen to add your device, and select your time zone.

4. Scan the QR Code on the device body.

5. Check the network connected to your smartphone and enter the password. (It works only on 2.4GHz Wi-Fi)

*If the network DoorCam3\_XXXXXX does not appear, please press the status button on the back of your device and wait for the lights to flash left and right.*

6. Place your phone about 5 inches in front of the camera lens and press "HEARD" after you hear "QR Code scanned". Your app will then complete the registration. This may take up to 3 minutes.

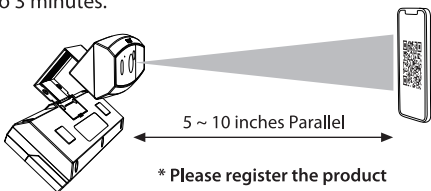



## CHECK BEFORE INSTALLATION

- The surface of the door where the DoorCam 3 is to be installed should be clean and flat and free of irregularities.
- Do not install in places where there is a risk of flooding due to rain or other moisture.
- Wear gloves to prevent safety accidents when installing and disconnecting DoorCam 3.
- After installation completely open the door and ensure that DoorCam 3 will not come in contact with any other surrounding wall or surface to prevent device damage.

Device cannot be installed on sliding doors.

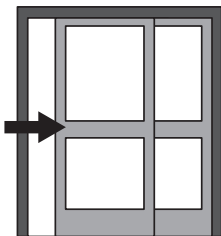

✗ DoorCam 3 cannot be installed on sliding doors.

If the distance between the door and the door frame is less than 0.05in(1.2mm), it cannot be installed.

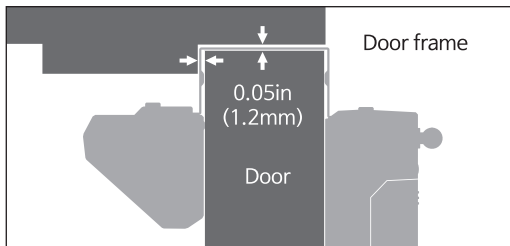

## PHYSICAL INSTALLATION

Please select the location where DoorCam 3 will be installed and remove foreign substances such as dust from the installation location. If there is moisture, wipe it with a dry cloth to completely remove the moisture. (It is recommended to install DoorCam 3 in the center of the door as shown in the picture below.) To let visitors know your home is protected by remo+, you can attach the protected by remo+ Sticker to the door as shown in the picture below.

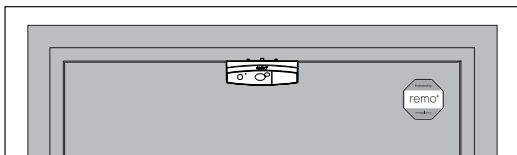

If needed, use the "Hex Wrench" enclosed in the package to loosen the bracket screw. Turn counterclockwise to increase the spacing of the camera head and body to the maximum.

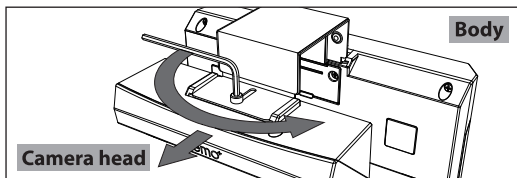

Remove the protective film on the mounting tape and apply to the back of the camera head and body as shown below.

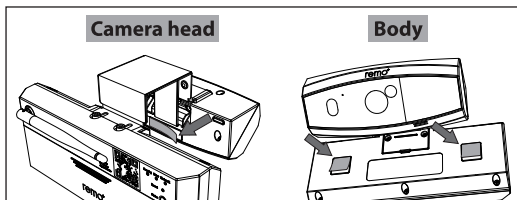

## ADJUST DOORCAM™ 3

**DoorCam 3 can be installed on push-in and pull-in doors.**

If you are pushing in the door, follow **option A** on page 11.

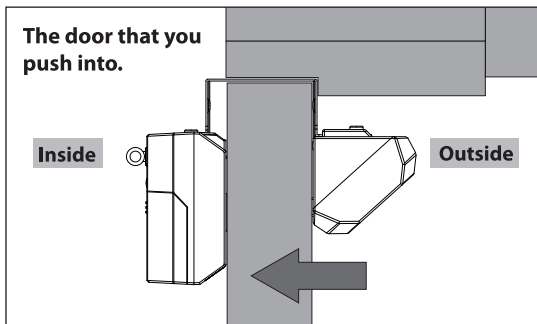

The device is packed in the box as shown in the picture below. Adjust the bracket screw on the camera side flat to the door. Adjust the bracket screw of the body to the thickness of the door.

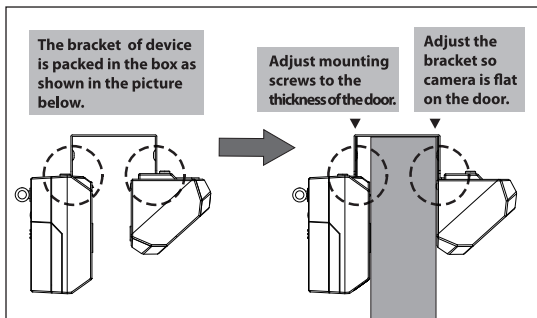

## Option A (Push-in door)

1. Loosen the bracket adjustment screw of the body using a Hex Wrench.

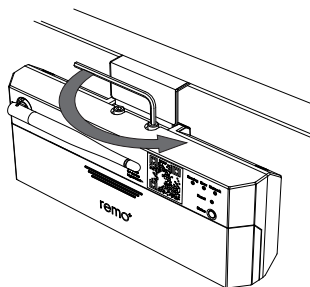

2. Push the body toward the door until the inside of the body touches the door.

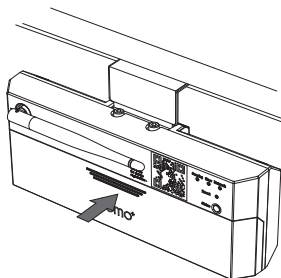

3. Tighten the bracket adjustment screw of the body using a Hex Wrench.

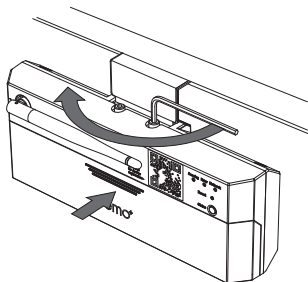

If you pull in the door, follow **Option B** on page 13.

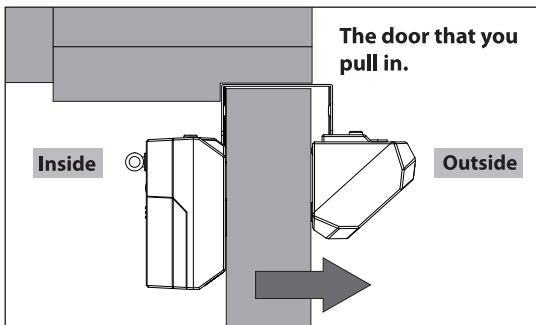

The device is packed in the box as shown in the picture below. Fix the bracket mounting screw on the body side flat to the door. Adjust the mounting screw of the camera to the thickness of the door.

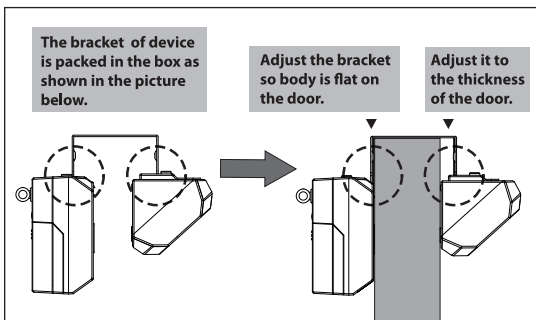

## Option B (Pull-in door)

1. Loosen the bracket mounting screw of the camera using a Hex Wrench.

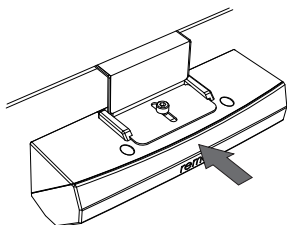
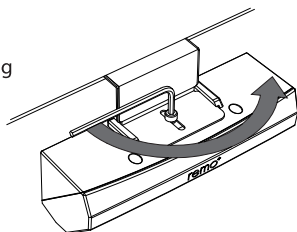

2. Push the camera inward until the back of the camera touches the door.

3. Tighten the bracket mounting screw of the camera using a Hex Wrench.

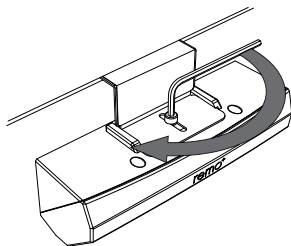

## POWER SOURCE

DoorCam™ 3 can use battery or USB power.

(**Note** : USB Power Adapter sold separately)

### IF USING BATTERIES:

1. Remove the Battery Cover.

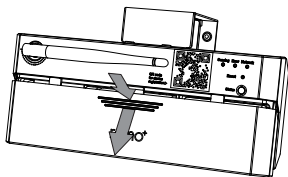

2. Install the batteries in accordance with the engraved.

Please make sure to use a D-Cell Alkaline batteries.

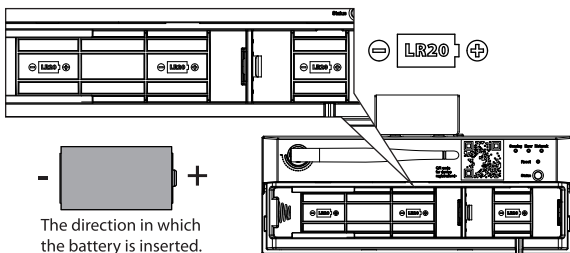

3. Install the batteries in the direction of the arrow in the order of the picture shown below.

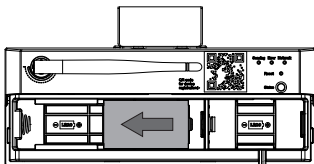

4. Close the Battery Cover.

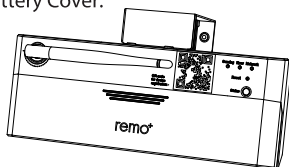

5. Hang DoorCam 3 over the door and adjust the bracket to fit the door's thickness. See **ADJUST DOORCAM™ 3** (PAGE 10).

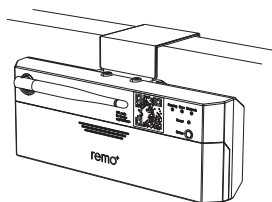

### IF USING USB POWER:

(**Note** : USB Power Adapter sold separately)

1. Remove the Battery cover and connect DoorCam 3 to a power outlet using the USB Power Adapter (sold separately), then close the Battery Cover. You can attach the power cable to the wall or door using cable clips (not included).

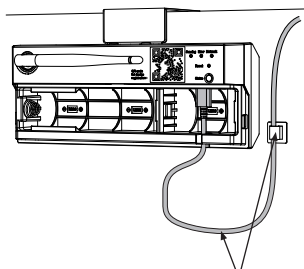

**Not included**

## ⚠ PRECAUTIONS FOR BATTERY USE

- This product is for alkaline batteries only, so do not use manganese batteries.
- Do not mix batteries from different manufacturers when loading multiple batteries
- Do not mix used batteries with new ones.
- Customer is responsible for explosions, fires and injuries caused by non-compliance.



## FAQ

### **What can I do if I keep getting the error “Connect to DoorCam 3 network to continue...”?**

1. Turn **OFF** cellular data under your Wi-Fi settings and turn **ON** Airplane Mode
2. Turn **OFF** the following setting on your smart phone or tablet:  
If you are using an Android:  
Go to your Wi-Fi settings  
> Select “Advanced Settings” (top right)  
> Turn **OFF** “Smart Network Switch”  
If you are using an iPhone/iPad:  
Go to your settings > Select “Cellular”  
> Turn **OFF** “Wi-Fi Assist”
3. Forget the DoorCam™ 3 network from your phone’s Wi-Fi settings
4. Close the remo+ app and reset DoorCam™ 3 (see page 17).
5. Restart the registration process (see page 7).

*\* Once your DoorCam™ 3 is registered, you can return your phone or tablet settings to normal.*

### **How do I store my videos?**

All DoorCam™ 3 videos are stored and saved on our free 3-day rolling Cloud plan. All accepted and missed activities can be viewed in your activity log for up to 3 days. Video recordings are protected with bank-level security and can only be accessed by the registered users, not our team.

## Can I keep my videos for a longer time?

If you want to extend the time your videos are available on your account, you can purchase additional 30-day Cloud storage for \$3/month or \$30/year. The Enhanced plan includes 90-days storage and is available for \$44.95/year. You are also free to download as many videos as you want and keep them permanently by downloading them and saving them onto your mobile device. To download, just open the video you want to save and click on the download button on the bottom left side of the screen. You can share videos with friends, family and/or law enforcement by clicking on the share button on the bottom right side of the screen.

## How to reset your DoorCam™ 3

1. Press the reset button using a ballpoint pen for 5 seconds. (pen not included)
2. Wait until the status LED light flashes left and right, then go back to the app and delete your registered device.
3. To delete your device, open the app and select the menu icon in the top left corner of the home page.
4. Select "Devices".
5. Click on the trash icon in the bottom right corner.
6. Select the device you are resetting and confirm you want to delete it.
7. Click on the "+" icon in the bottom left corner and select DoorCam™ 3 as the model.
8. Then go back to page 7, step 3 to re-register your DoorCam™ 3.

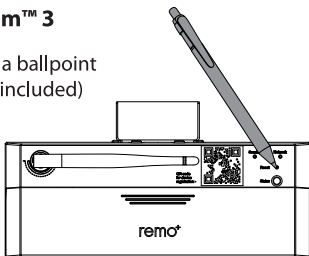

## Can't see videos of your recent activity?

For Android users, allow all permissions to the remo+ app:  
Settings > Applications Manager > Permissions > Storage

Check your Settings on the remo+ app:

- Menu > Devices > Your Devices
- > Turn on Motion Sensor
- > Turn on Save Videos to Cloud
- > Press the DoorCam™ 3 status button to save the settings

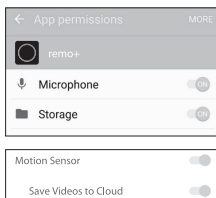

## Can I recover my videos if I delete them?

No, once they are deleted from your remo+ app they will no longer be available.

## Forgot your password?

1. Press "Forgot Password" on the login page.
2. Enter your account email and click SEND.
3. Check your email (including the spam folder) for the temporary password.
4. Open the remo+ app and log in using your account email and the temporary password.
5. Create a new password.

*TIP: If you have been locked out of the app due to multiple failed log-in attempts try uninstalling and then reinstalling the remo+ app on your phone/tablet. Once the app is reinstalled, go to "forgot password" and follow the above steps.*

## **How many users can access the DoorCam™ 3?**

You can view DoorCam™ 3 from up to 5 iOS/Android devices.

## **How do I add users?**

1. Have the new user download the remo+ app.
2. Open the remo+ app and log in using the same account email and password.
3. Once logged in, they will automatically be created as a new user. You can enter a different profile name for the user (this will show in the Viewers list).  
Menu > Viewers > Click on Viewer XXXX >
4. Type in your preferred viewer name

*\*All users will have the same access to the device and device recordings.*

## **How many remo+ devices can I add to my account?**

You can add up to 5 remo+ devices.

## **How do I add another remo+ device to my account?**

1. Open the remo+ app and press the menu icon in the top left corner of the home page.
2. Select "Devices" from the list.
3. Select the "+" symbol in the bottom left corner.
4. Select the device you would like to add and follow the steps to register it.

## SUPPORT

We're happy to help!

support@remoplus.co

(888)-985-1849

Mon-Fri 8:30am to 5:30pm ET (except holidays)

## LIMITED WARRANTY

1. LICENSOR DOES NOT WARRANT THAT THE FUNCTIONS CONTAINED IN THE LICENSED PRODUCT AND HARDWARE WILL MEET LICENSEE'S REQUIREMENTS OR THAT THE OPERATION OF THE SOFTWARE AND HARDWARE WILL BE UNINTERRUPTED OR ERROR-FREE. LICENSOR DOES WARRANT THAT THE MEDIA ON WHICH THE SOFTWARE IS FURNISHED AND THE HARDWARE WILL BE FREE FROM DEFECTS IN MATERIAL AND WORKMANSHIP UNDER NORMAL USE FOR A PERIOD OF ONE YEAR FROM THE DATE OF DELIVERY ("WARRANTY PERIOD"). THIS LIMITED WARRANTY IS VOID IF FAILURE OF THE MEDIA ON WHICH THE PRODUCT OR SOFTWARE IS FURNISHED HAS RESULTED FROM ACCIDENT, ABUSE, OR MISAPPLICATIONS.

2. EXCEPT AS PROVIDED ABOVE, THE LICENSED PRODUCT IS PROVIDED "AS IS" WITHOUT WARRANTY OF ANY KIND, EITHER EXPRESS OR IMPLIED INCLUDING, BUT NOT LIMITED TO, IMPLIED WARRANTIES OF MERCHANTABILITY AND FITNESS FOR A PARTICULAR PURPOSE. THE ENTIRE RISK AS TO THE QUALITY AND PERFORMANCE OF THE LICENSED PRODUCT AND HARDWARE IS WITH LICENSE.

## HOW TO DISPOSE YOUR BATTERIES

Alkaline batteries are not listed as a hazardous waste under the Resource Conservation and Recovery Act (RCRA).



Most states classify alkaline batteries according to RCRA regulations. However, some states have more rigorous regulations. The hazardous waste characterization requirements of Alaska, California, Minnesota, Rhode Island and Washington include bioassay. South Carolina regulates all types of batteries as special waste. Therefore, disposal of alkaline batteries in South Carolina must be accomplished accordingly.

Please call 1-877-2-RECYCLE for information on recycling your used alkaline battery or visit [www.call2recycle.org](http://www.call2recycle.org).

## FCC COMPLIANCE STATEMENT

This device complies with part 15 of the FCC rules. Operation is subject to the following two conditions: (1) This device may not cause harmful interference, and (2) this device must accept any interference received, including interference that may cause undesired operation.

## FCC INTERFERENCE STATEMENT

This equipment has been tested and found to comply with the limits for a Class B digital device, pursuant to part 15 of the FCC Rules. These limits are designed to provide reasonable protection against harmful interference in a residential installation. This equipment generates, uses and can radiate radio frequency energy and, if not installed and used in accordance with the instructions, may cause harmful interference to radio communications. However, there is no guarantee that interference will not occur in a particular installation. If this equipment does cause harmful interference to radio or television reception, which can be determined by turning the equipment off and on, the user is encouraged to correct the interference by one of the following measures:

- Reorient or relocate the receiving antenna.
- Increase the separation between the equipment and receiver.
- Connect the equipment into an outlet on a circuit different from which the receiver is connected.
- Consult the dealer or an experienced radio/TV technician for help.

## FCC CAUTION

Any changes or modifications not expressly approved by the party responsible for compliance could void the user's authority to operate this equipment. This transmitter must not be co-located or operating in conjunction with any other antenna or transmitter.

## FCC RADIATION EXPOSURE STATEMENT

This equipment complies with FCC radiation exposure limits set forth for an uncontrolled environment. This equipment should be installed and operated with minimum distance 20 cm between the radiator and your body. This transmitter must not be co-located or operating in conjunction with any other antenna or transmitter.

FOLLOW US ON





remo<sup>+</sup>



Digital QSG