



Revolution 4DC- Mobile Installation Manual

IT Tech Support Team: Alan Fennell Jeremy Moran

iM3 Inc. – The Veterinary Dental Company

12414 NE 95th ST, Vancouver, WA 98682

Office Hours: M-F 7am-5pm PST.

Office Phone: 1-800-664-6348 IT Tech Support Line: 1-844-838-3092

For after hour support, please call IT Tech Support line.

Email: afennell@im3usa.com JMoran@im3usa.com

Revision History

<u>Date</u>	<u>Version</u>	<u>Author</u>	<u>Description</u>
9/11/17	2.1	Alan Fennell	Add Warning Labels
9/19/17	2.2	Alan Fennell	Add Remote Sync Instructions
9/20/17	2.3	Jeremy Moran	Update Base instructions, wiring for power connector, securing remote to wall mount
9/22/17	3.0	Alan Fennell	Base and Scissor arm orientation
3/14/18	4.0	Alan Fennell	Update Contact Info. Add new remote image. Update base instructions. Add new image of Revolution.
4/6/18	4.1	Alan Fennell	Update White 3pin Scissor Arm Molex connector note. Pg 13, 14.
4/11/18	4.2	Alan Fennell	Update Attaching Generator Head Instructions, P. 17
7/9/18	4.3	Alan Fennell	Update to Step 10. P. 20, Added Step 11: Check for Arm Drift. P. 20. Added Step 12: Check tube head rotation. P. 20. Added Step 13: Calibration Test. P.20. Added Appendix 1-4. P. 24-29
7/12/18	4.4	Jeremy Moran	Update to Step 6: Added Main Board layout description. Added Step to include how to change WiFi Channel. Added Appendix 5.
10/18/19	4.5	Alan Fennell	Updated Title/Footer/Header/Index. Update to Step 12. Added tube head/scissor arm functionality/performance test. Updated Actuator adjustment instructions. Updated Office Hours.

Index

Page 1	Tools, Hardware and Parts Required
Page 4	Step1- Assembling the Base
Page 5	Step 2- Locking Casters
Page 6	Step 3- Attaching Stand to Base
Page 8	Step 4- Mounting Control Board and Scissor Arm
Page 12	Step 5- Mounting Handles to Stand
Page 13	Step 6- Connecting Ground and Power Connectors
Page 16	Step 7- Securing Power Cord and Cover
Page 17	Step 8- Attaching Generator Head and Collimator
Page 20	Step 9- Application of Warning Labels
Page 21	Step 10- Test Fire Generator/Check Remote Sync
Page 21	Step 11- Correcting E301/E302 Error codes
Page 21	Step 12- Tube Head/Scissor Arm Functionality/Performance Test
Page 21	Step 13- Calibration Test
Page 22	Additional Information: Remote Wall Mount Instructions, Powering Generator
Page 23	Using the Revolution 4DC
Page 24	Revolution 4DC Remote Control Tutorial
Page 25	Appendix 1- Resync Remote to Tube Head
Page 26	Appendix 2- Correcting Arm Drift
Page 28	Appendix 3- Adjusting Actuator Assembly
Page 30	Appendix 4- Conducting Calibration Test
Page 31	Appendix 5- Changing WiFi Channel on Remote Control

Tools, Hardware, and Parts Required:

1. Tools

2.5mm Allen Wrench	3mm Allen Wrench	4mm Allen Wrench	5mm Allen Wrench
6mm Allen Wrench	Flat Head Jeweler Screwdriver	#2 Phillips Screwdriver	

2. Hardware- **Note:** Please inventory hardware bag prior to installation.

A. Tube Head Covers	B. Cover Flaps (3)	C. Remote Mount	D. Stand Handles (2)
E. Retaining Pin	F. Dog Head Set Screws (2)	G. Long 8mm Allen Wrench	H. Stand and Base Bolts (8)
I. Dog Head Plugs (2)	J. Zip Ties (2)	K. Set Screw Plug	L. Control Board Mounting Screws (4)
M. Handle Screws (2)	N. Remote Mount Screws (2)	O. Dry wall anchors (2)	P. Moving Caution Stickers (2)
Q. Tube Head Screws w/ washers (2)	R. Set Screw	S. Friction Element	T. Curved Spring Washers (4)
U. Scissor arm Brass ring	V. Remote Mount Washers (2)		

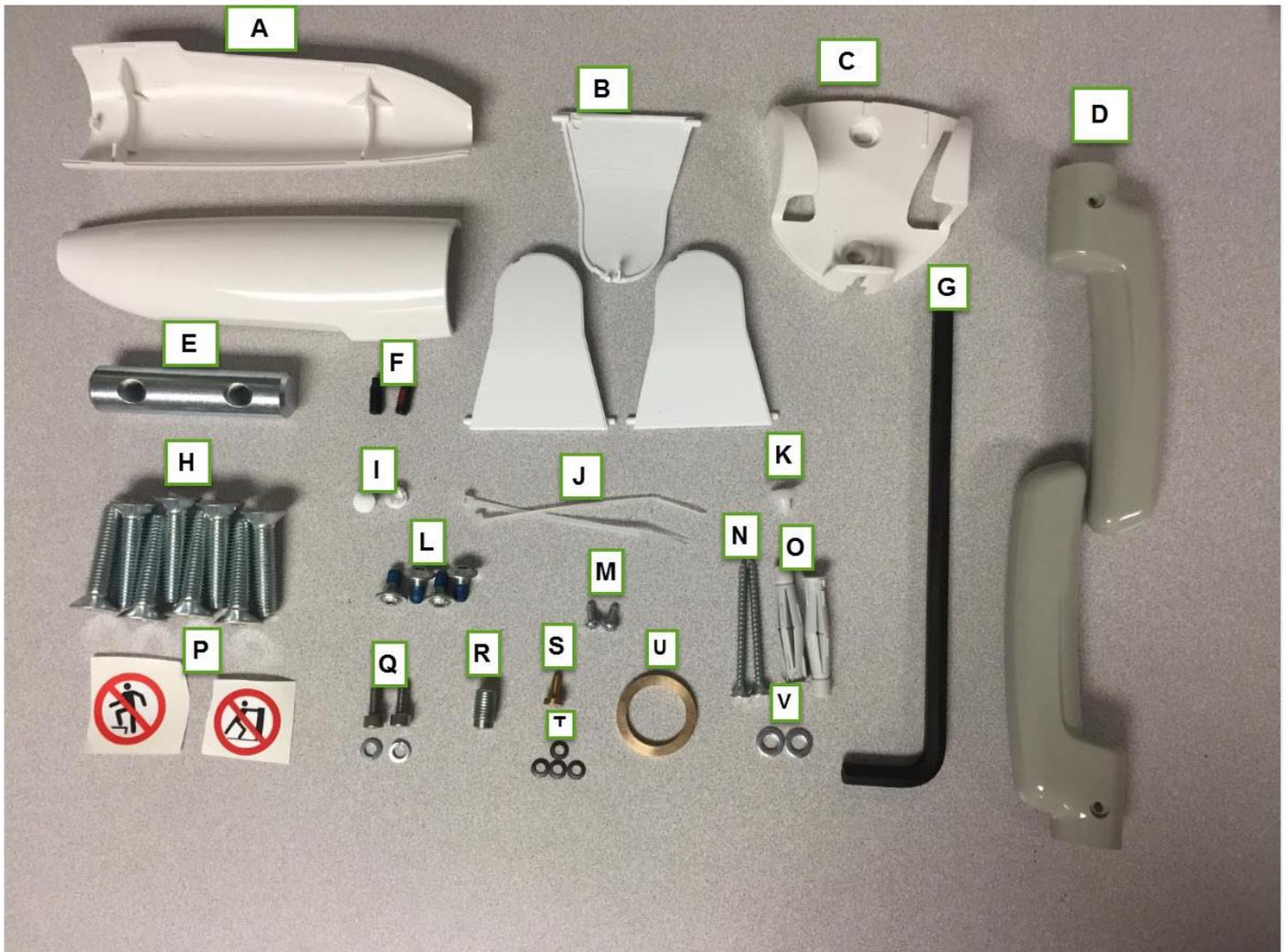

3. Parts.  **Note:** Please inventory parts prior to installation. (Stand Cap will be in hardware package). 

A. Stand Cap	B. Base Assembly	C. Control Board	D. Control Board Cover
E. Stand	F. Scissor Arm	G. Tube head w/ collimator	H. Remote



Parts Cont.



Step 1- Assembling the Base

 Prior to Installation of this step: See bottom right image for proper alignment of base plate to legs. 

Tools required: 6mm Allen Wrench

Hardware required: 6 Base and Stand Bolts (Hardware- H).

Parts required: Base plate and caster legs (Parts- B)

Description: Remove base components from box and 6 base bolts. With caster side of legs facing up, insert base plate with counter sunk holes on base plate facing up and match concave arch pattern of base plate with legs so that legs are angled **outwards**.

1a



1b

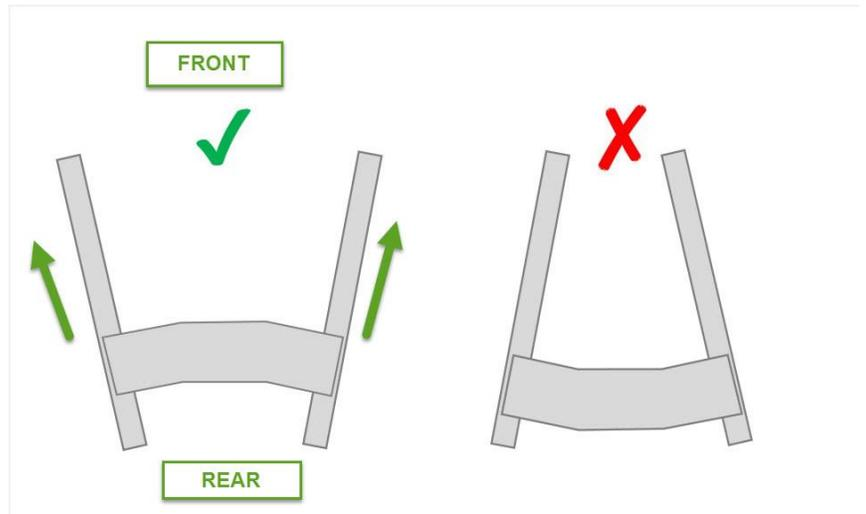

Step 2- Locking Casters

Tools required: None

Hardware required: None

Parts required: None

Description: Once base is assembled, flip the base back over with casters down and lock casters.

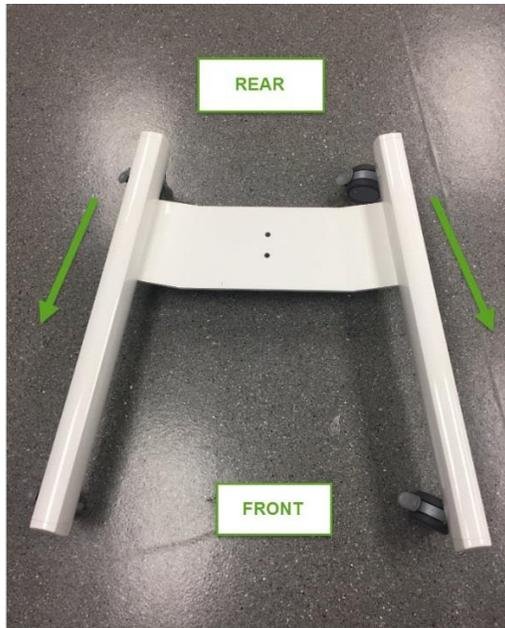

Step 3- Attaching Stand to Base

Tools required: 6mm Allen Wrench

Hardware required: Retaining pin (Hardware-E) and 2 bolts (Hardware-H), Scissor arm Brass Ring (Hardware-U)

Parts required: Stand with Power cable (Parts- E), Assembled base, Stand Cap (Parts- A). Styrofoam Top and Bottom Piece from Stand Box.

Description: With 6mm Allen wrench, two bolts, retainer pin, and foam box (top and bottom), lay stand on foam box (3a). Slide retaining pin in bottom of stand (3b-3c). Using one of the bolts, screw bolt in retaining pin slightly so that you can align retaining pin better (3d). Once aligned, remove and slide both bolts through bottom of base. Screw both bolts in to retainer pin as shown (3f). Place Scissor arm brass ring and stand cap on stand (3h).

 **Note:** Powercable on stand faces towards rear of base assembly when complete (3e). 

3a

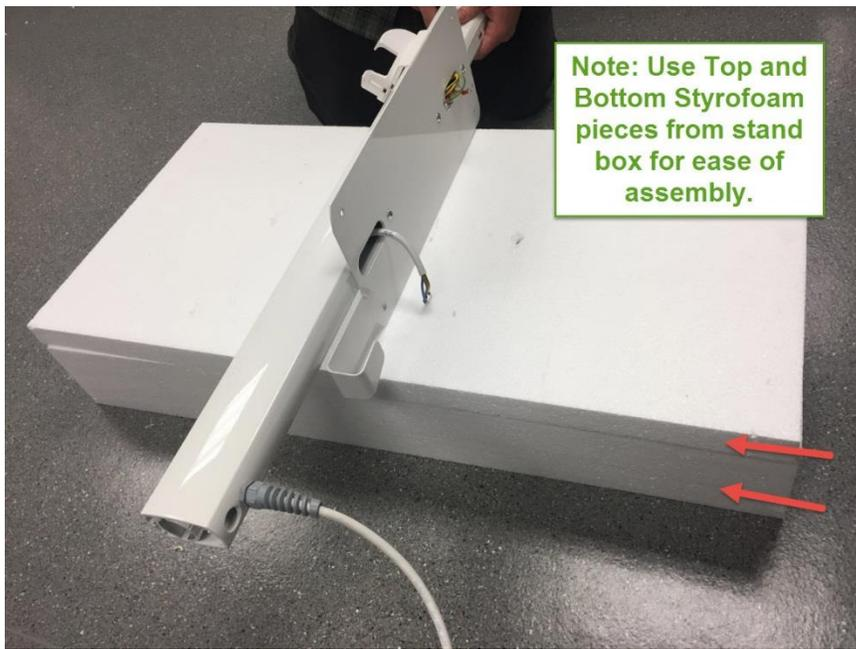

3b



3c



3d



3e

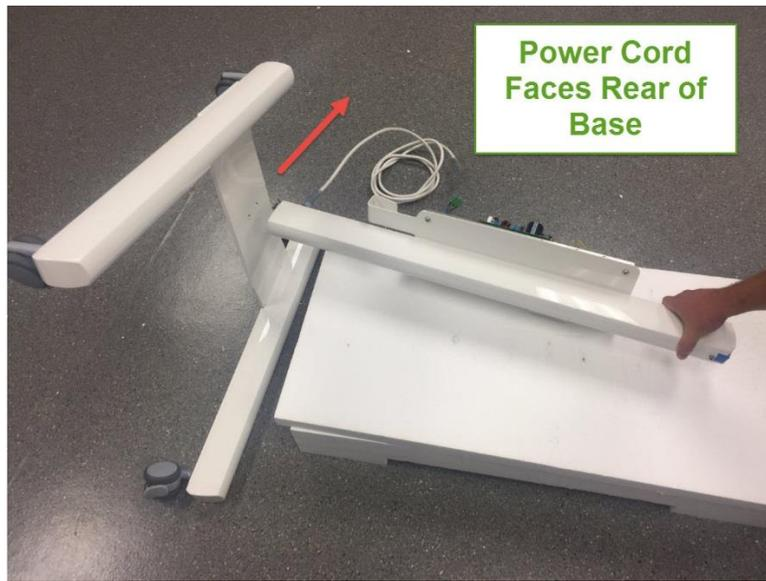

3f

3g

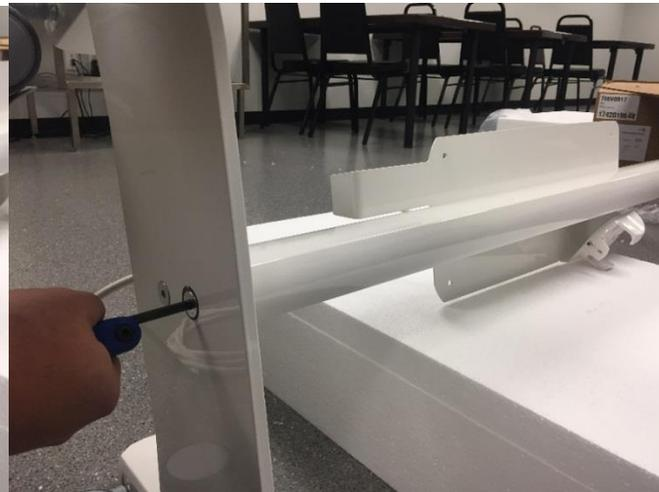
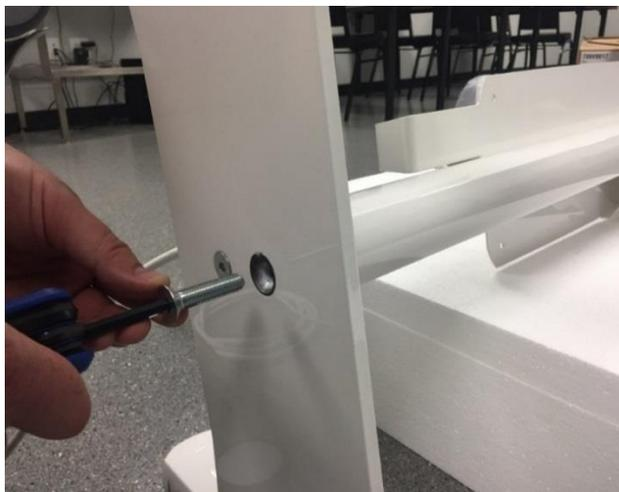

3h→



Step 4-Mounting Control Board and Scissor Arm

Tools required: 3mm Allen Wrench, 4mm Allen Wrench, 5mm Allen Wrench, Flathead Jeweler screwdriver

Hardware required: Control board mounting screws (Hardware- L), Friction Element (Hardware- S) with Curved Spring Washers (Hardware- T), Set Screw (Hardware –R), and dog head set screws (Hardware-F).

Parts required: Control Board (Parts- C) and Scissor Arms w/ Power cable (Parts-F),

Description:

1. Slide stand power cable through bottom opening of control board (4a) and secure board to stand plate with lock-tight screws as shown with 4mm Allen Wrench (4b-4c).
2. While keeping scissor arm velcroed together, carefully feed scissor arm power cable through top opening of stand through to top opening of control board as shown (4d-4h).
3.  Tube connector end of scissor arm should face towards front of stand once seated. 
4. Screw in dog head set screws with 3mm Allen wrench on each side of stand as shown until it stops, then back out ½ turn (4j-4k).
5. Place curved spring washers back to back on friction element as shown (4l). Place friction element on set screw. Carefully screw in set screw w/ friction element half way with 5mm Allen wrench, in screw hole on top of stand. Adjust friction element with flat head screwdriver to align vertically so that the curve of friction element is flush with the base of scissor arm. Once met, screw in the rest of the set screw until desired tension is met. (4l-4o)



WARNING: Do not release Velcro strap on scissor arm until the end of Step 7. Injury may result.

4a

4b

4c

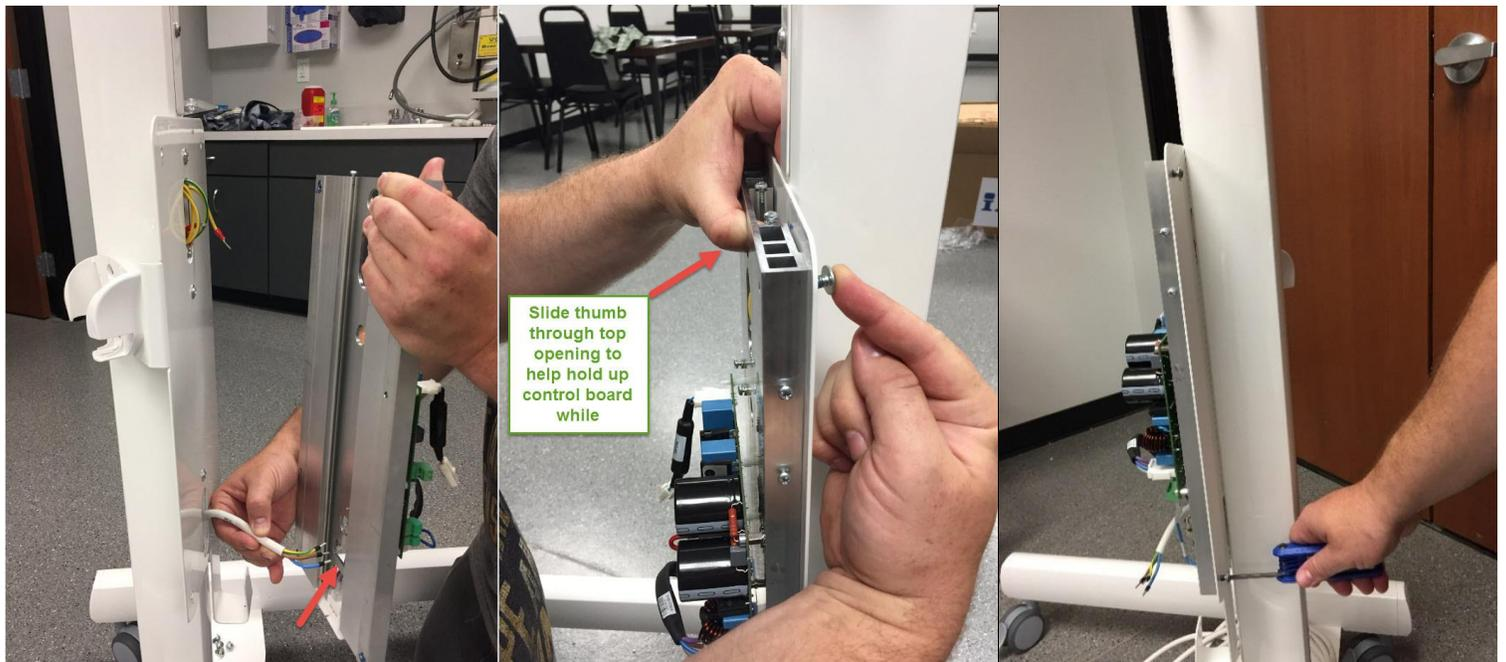



4d

4e

4f



4g

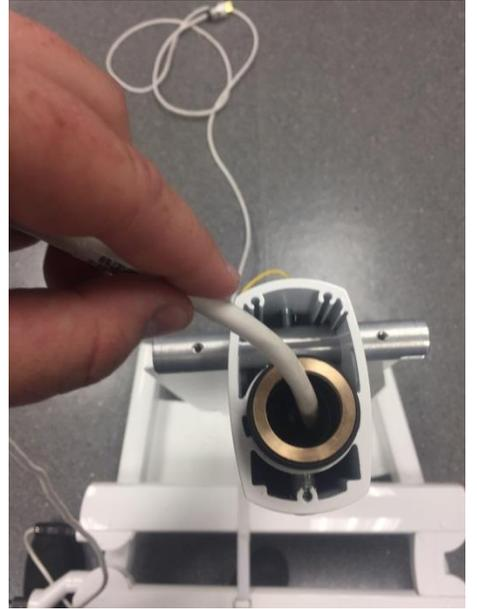
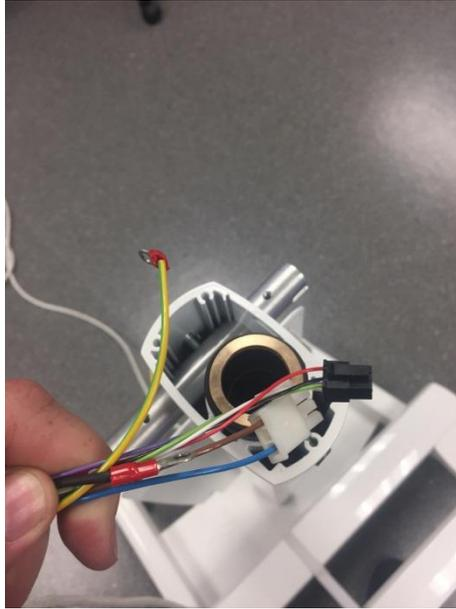

4h

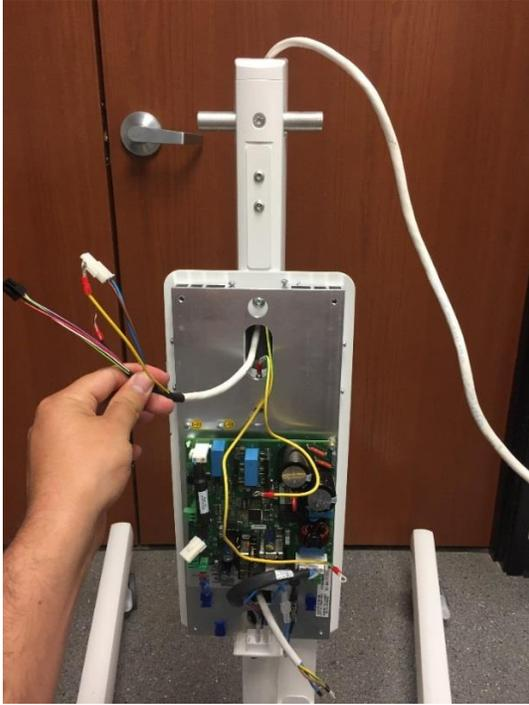

4i

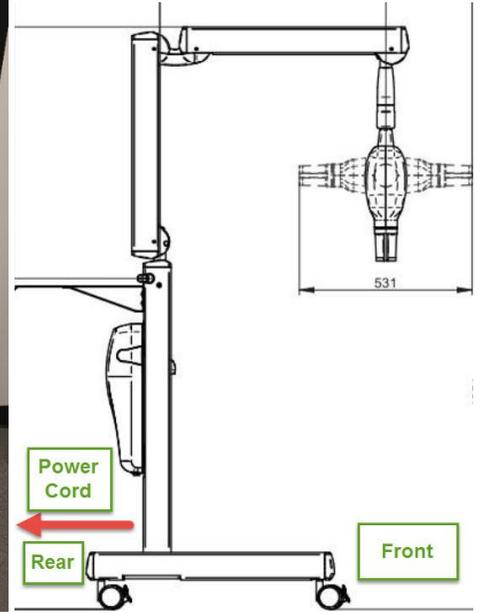

4j



4k



4l ---->

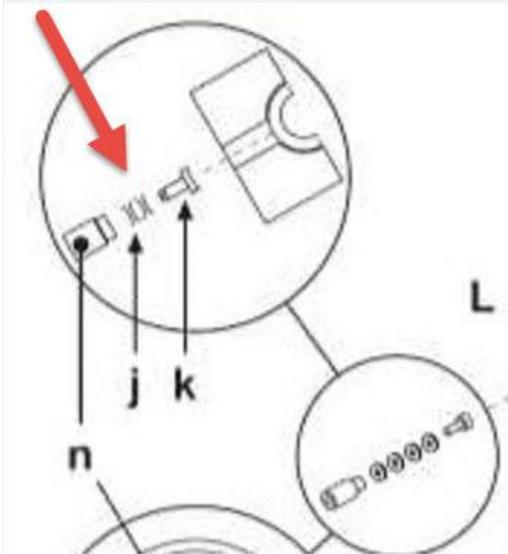

4m

4n

4o



Step 5- Mounting the Handles to Stand

Tools required: 2.5 mm Allen Wrench

Hardware required: Handle screws (Hardware- M), Handles (Hardware-D)

Parts required: None

Description:

1. Slide hollow end of handles over mounting bars so that the contoured end is facing back.

Note: One handle goes up and the other goes down.

2. Secure handles with screws as shown (5a-5b)

5a



5b

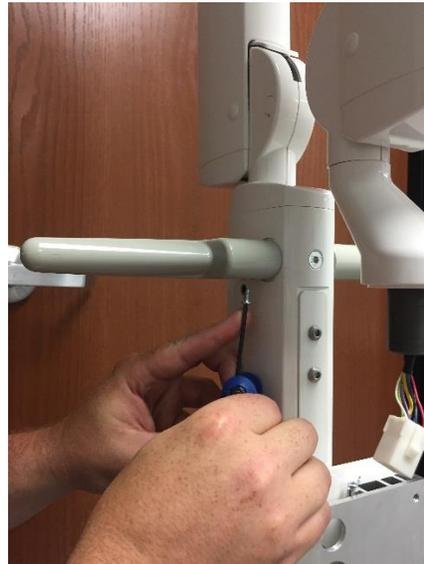

Step 6- Connecting ground and power ports

Tools required: Flat head Jeweler screwdriver. #2 Phillips Screwdriver

Hardware required: None

Parts required: None

Description:

Grounding- Connect ground cables as shown making sure that grounding wires are faced towards center of mounting plate.

1. Secure the two larger yellow and green grounding wires on right grounding port with Phillips head screwdriver.
2. Secure the small yellow and green and black grounding cables to the left grounding port with Phillips head screwdriver (6a).

Power- Connect black, white, and green power connectors to circuit board.

3. Connect black 6pin male power connector from scissor arm to black 6pin female port on circuit board as shown (6b).
4. Connect white 3pin male power connector from scissor arm to white 3pin female port on circuit board (6c).
5. Remove green connector on bottom right of circuit board. Push in (From left to right), Left (Live Wire), Middle (Ground), Right (Neutral) cables from stand power cable to green connector. Secure with flathead retaining screws using flat head jeweler screwdriver on green connector. Once secured, plug in green connector to

corresponding port on circuit board (6d-6f).  **Note:** Measure at wall outlet for live wire. 

6a

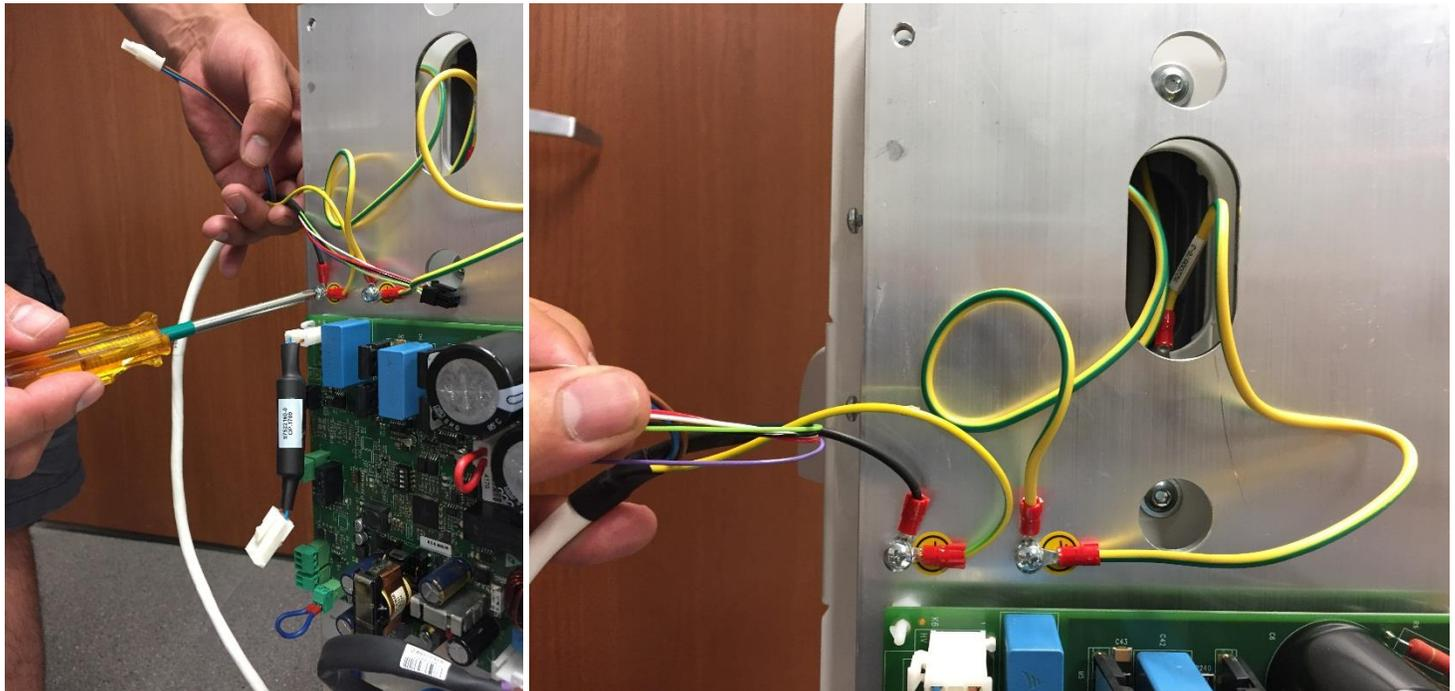

6b

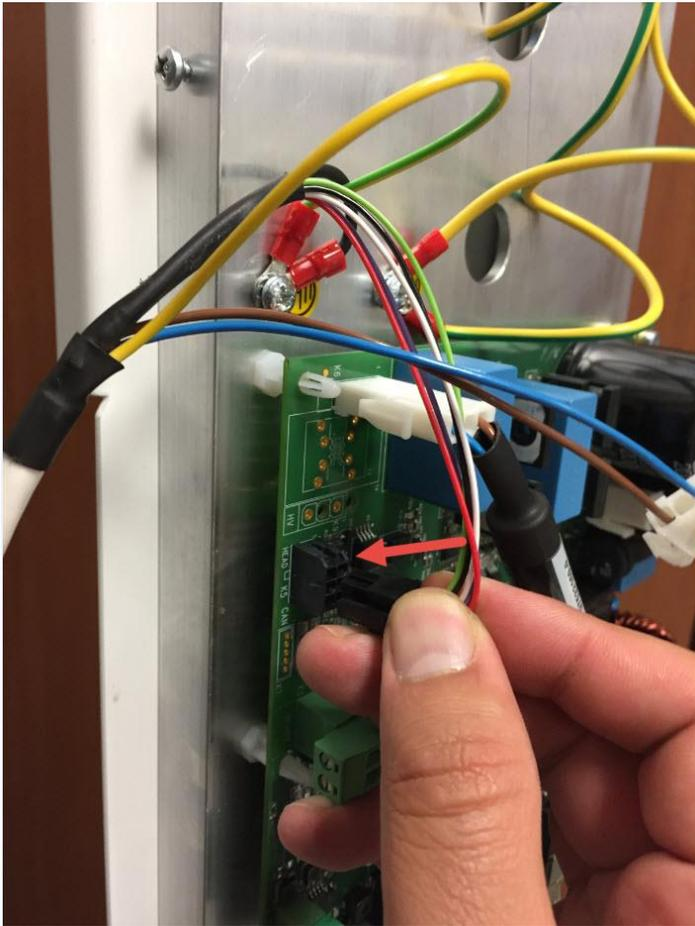

6c

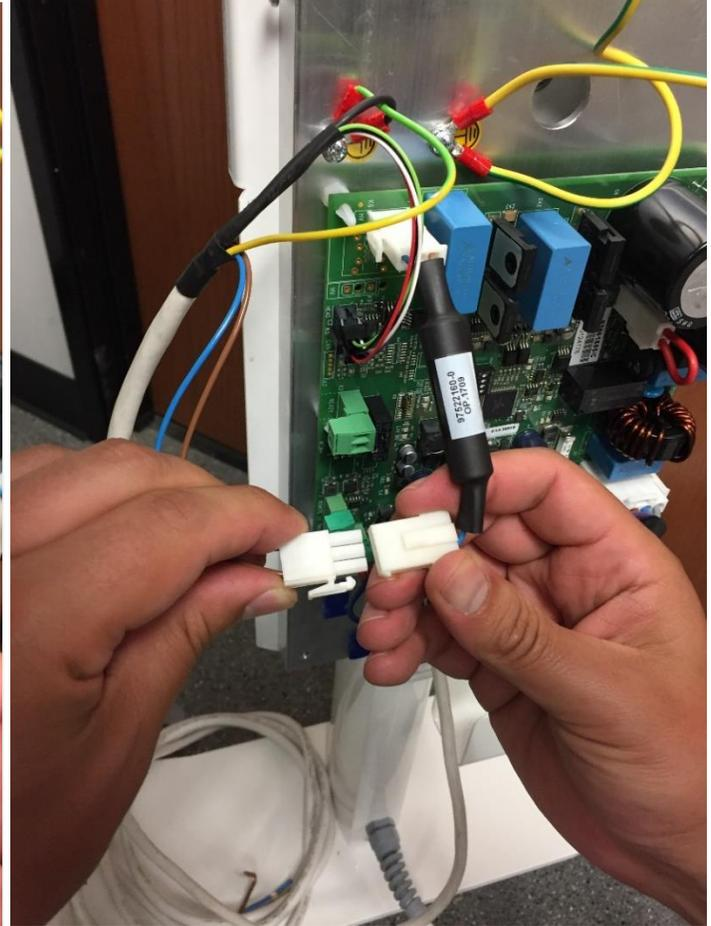

Note: When connecting this connector (6c), it is ok if wires connect Blue to Blue and Brown to Brown, or Blue to Brown and Brown to Blue as shown below.

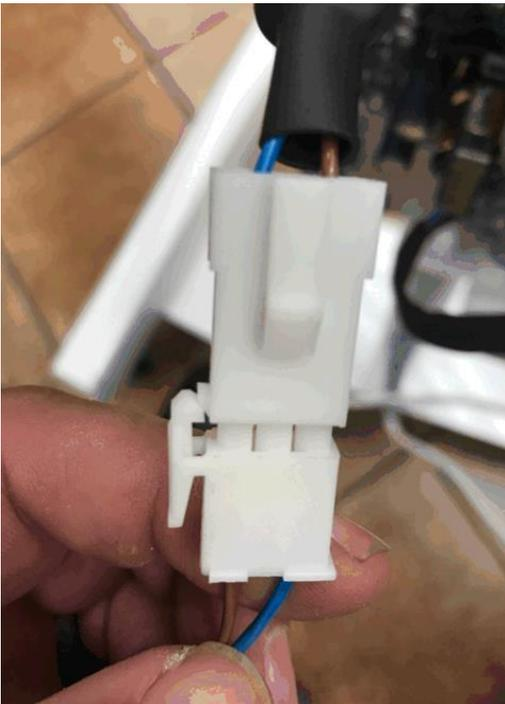

6d

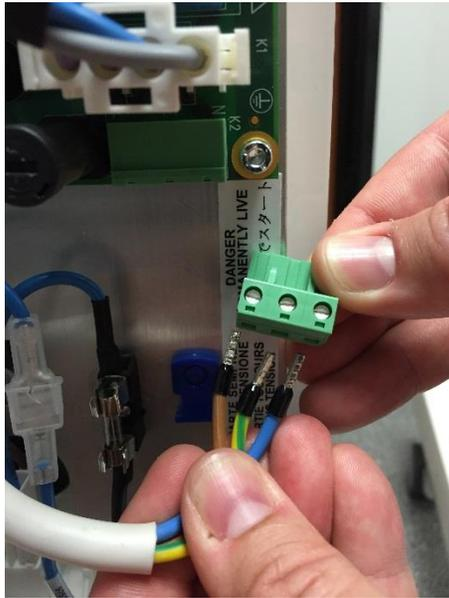

6e



6f



Revolution Main motherboard layout fully assembled:

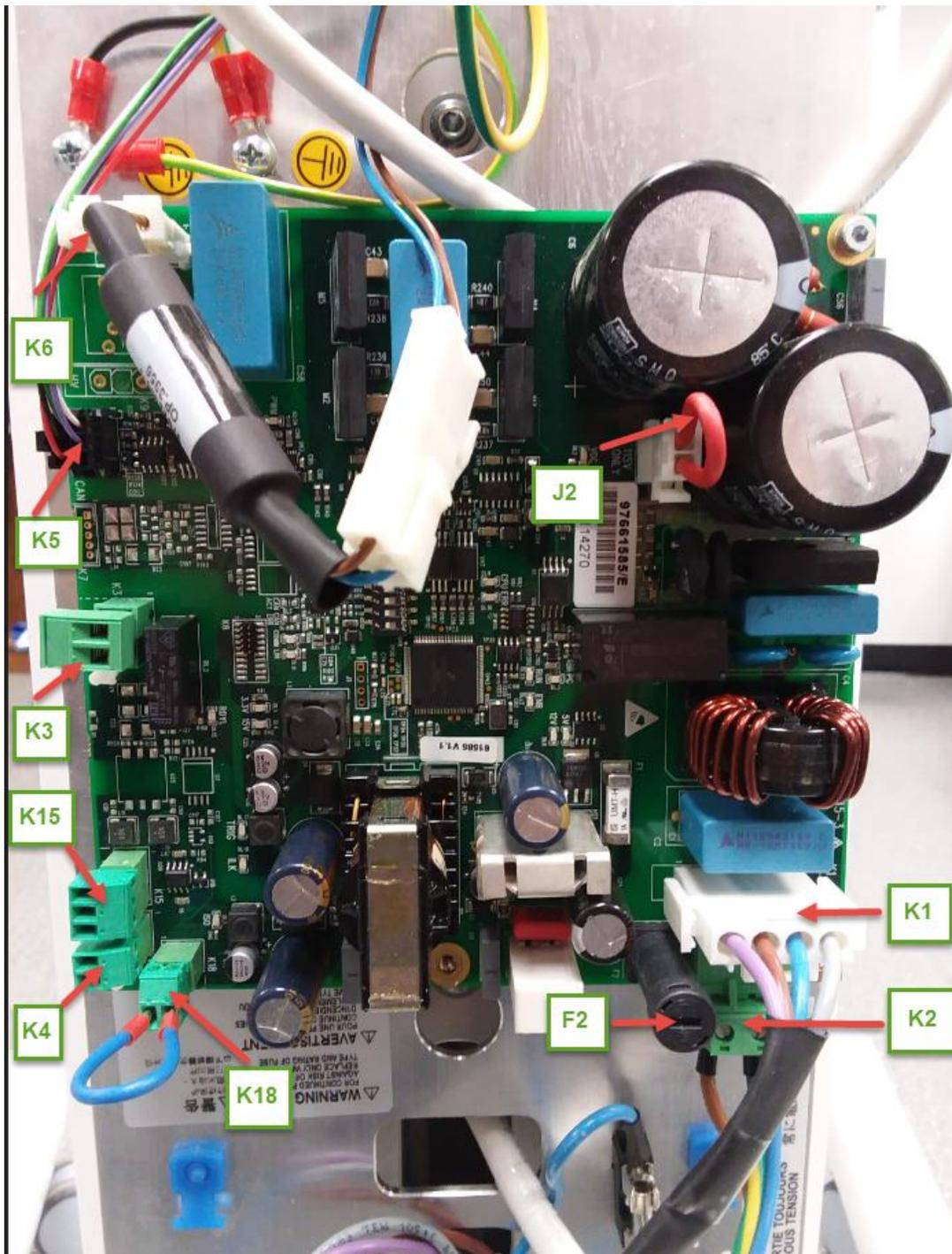

Port No.	Description
K1	Ignition switch connection
K2	Mains power supply (From left to right: Brown, Yellow/Green, Blue)
K3	Contact for external lamp (max 2A- clean contact)
K4	External emission button
K5	Arm cable (head)
K6	Arm cable (power)
K15	Wired remote connection port: 1 PIN Red, 2 PIN White/Brown, 3 PIN Blue
K18	Interlock contact with blue jumper
F2	Main Fuse: 230-240 Vac -> 8A; 115-120 Vac -> 12A
J2	115Vac Only Contact with Red Jumper

Step 7 – Securing Power Cord and Cover

Tools required: #2 Phillips Screw driver

Hardware required: 4" Zip tie (Hardware-J), Cover Flaps (Hardware-B)

Parts required: Control cover (Parts-D)

Description:

1. Thread zip tie to blue tie anchor on circuit board plate. Coil power cable. Secure cable with zip tie as shown (7a).
2. Place bottom end of cover underneath power switch and align with control board and push slightly (7b).
3. Secure plastic retainer tabs with screws using Philips screwdriver. Once secured, gently secure flaps and close (7c).

 **Note:** Cover Flaps are very fragile. 

7a



7b



7c--->



Step 8 – Attaching Generator Head and Collimator

Tool required: 4mm Allen Wrench

Hardware required: Generator Head Screws w/ washers (Hardware- Q), Generator Head Neck Covers (Hardware-A).

Parts required: Generator Head (Parts-G)

Description: Carefully remove Velcro from scissor arm with one hand and secure other arm to scissor arm with the other hand. (Scissor arm can spring upward forcefully if not held down). Thread female 9pin power connector through generator head (8a).

! PRIOR TO CONNECTING 9pin CONNECTORS: ! Secure head with one hand, with the other, secure head to scissor arm using 4mm Allen wrench and one generator head screw (top first), then bottom (8b).

8a



8b



Next, once head is secured to scissor arm, connect 9pin male to 9pin female power connectors together (8c-8d).

8c



8d



Lastly, fasten generator head neck covers together (8e-8f).

8e



8f



Fully Assembled Xray Generator

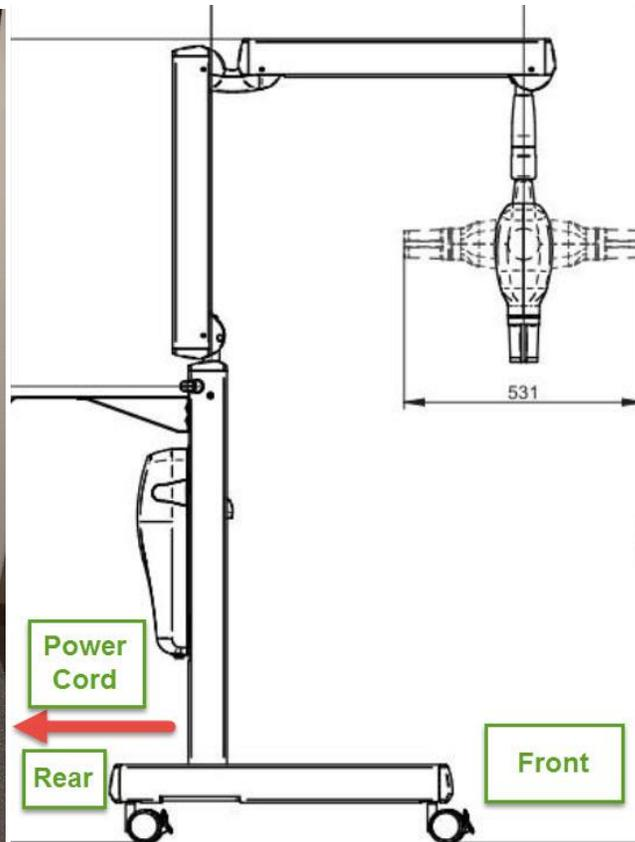

Step 9- Application of Warning Labels

Tools Required: None

Hardware Required: Warning Labels (P)

Parts Required: None

Description: Apply the “do not step” and “do not push” warning labels to the base crossmember and pantograph arm as shown.

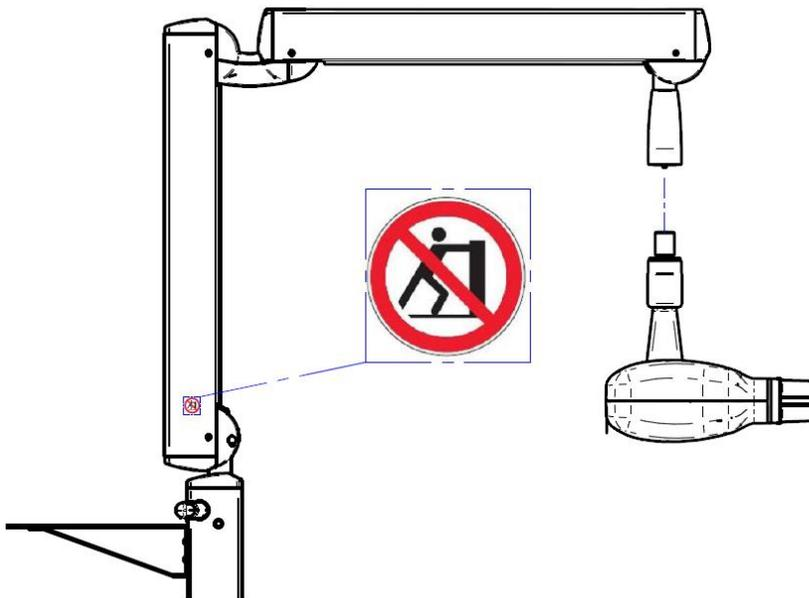
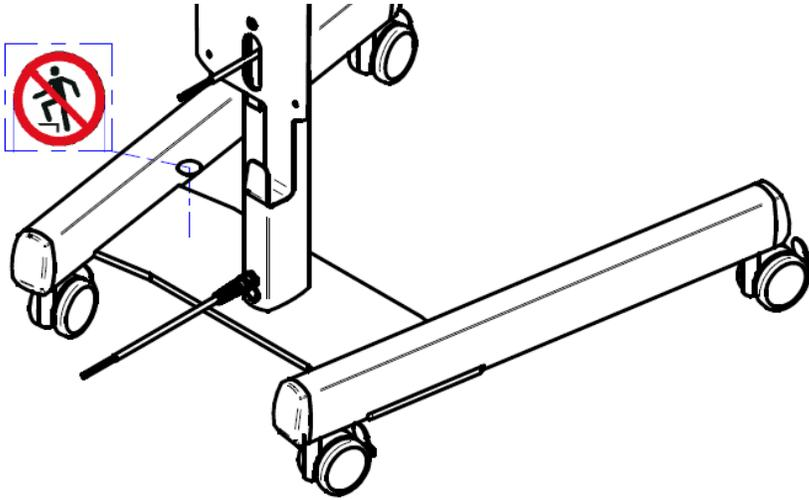

Step 10- Test Fire Generator Tube Head/Check Remote Sync

Tools Required: None

Hardware Required: None

Parts Required: Generator Remote Controller

Description: Test fire generator to check for proper synchronization of remote to tube head. If when remote is turned on it does not read "Ready" and cannot fire test shot, please see Appendix 1 on page 24 on how to resync remote to tube head.

Step 11- Correcting E301/E302 Error Code

Tools Required: None

Hardware Required: None

Parts Required: Generator Remote Controller

Description: If upon test fire of generator, remote displays E301 error code, this error refers to action taken by user of not

holding shoot button down long enough. To clear error, hit  on remote and try again with holding shoot button down longer. If E302 error code displays, please see Appendix 5 on page 31 on how to change WiFi Channel on remote control.

Step 12- Tube Head/Scissor arm Functionality/Performance Test.

Tools Required for Scissor Arm/Actuator adjustment: #2 Phillips Screwdriver, 3mm, 4mm, and 5mm Allen Wrench, and Flathead Jeweler screwdriver.

Parts Required: None

Description of Functionality/Performance Test:

With generator turned on, engage/disengage touch pads on tube head in rapid succession (2 touches per second) at least 15 times, ensuring tube head unlocks and locks properly each time. If tube head fails to unlock during this test, an actuator adjustment is needed. See Appendix 3 on page 28/29 on how to correct.

Next, while moving tube head in various positions/angles, check if scissor arm is drifting horizontally/vertically. If drift is present (more than 1 inch), see Appendix 2 on page 26/27 on how to correct.

If you need assistance with test or correction of issue, please call iM3 Technical Support line at 1-844-838-3092.

Step 13: Calibration Test

Tools Required: None

Hardware Required: None

Parts Required: Generator Remote Controller

Description: If after installation you receive a low/high voltage error message on remote control and/or if remote latency has increased beyond limits as indicated in technical manual, a calibration of the x-ray tube head may be required. Please call iM3 Technical Support line and see Appendix 4 on page 29 on how to conduct calibration test.

Additional Information

Mounting Remote to Wall: Mount remote control mount to wall using drywall anchors (Hardware O) and screws w/

washers (Hardware N).  **Note:** Use the M4 screw that is located in with the batteries for remote to permanently

secure the remote to the control mount. 



Powering the Generator: Plug the generator in and turn on the machine by switching on the green power switch on the bottom of the power board.



You'll hear a beep, and the light at the top of the head will turn on and blink 3 times and become a solid purple.



Using the Revolution 4DC

Use the touch pads on either side of the light to unlock the head from the sphere for positioning. When the sphere is unlocked, the LED light will turn blue.

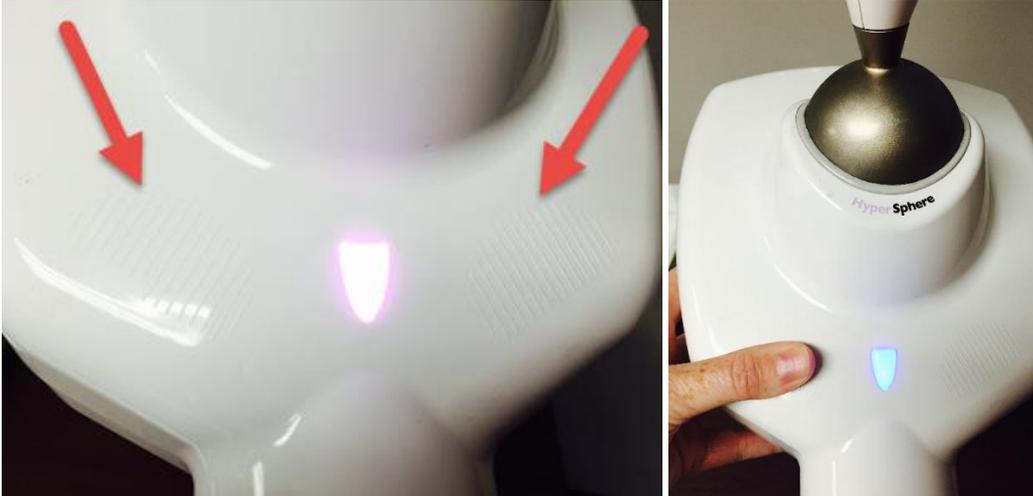

Once you have your position, remove your hands from the touch pad to lock position into place.

Note: These are touch pads, you do not have to push. Only one side needs to be touched. Suggest using one hand for the touch and the other hand to put into position and hold until the head is locked into place. When doing minor adjustments, make sure to use one hand to hold the head while using the other hand for the touch pad. If the head is not supported, and the touchpad is touched, the head will unlock and fall into a 90 degree angle.

When actively taking an image, the LED light will turn amber. If there's an error, or it overheats, the LED light will be red.

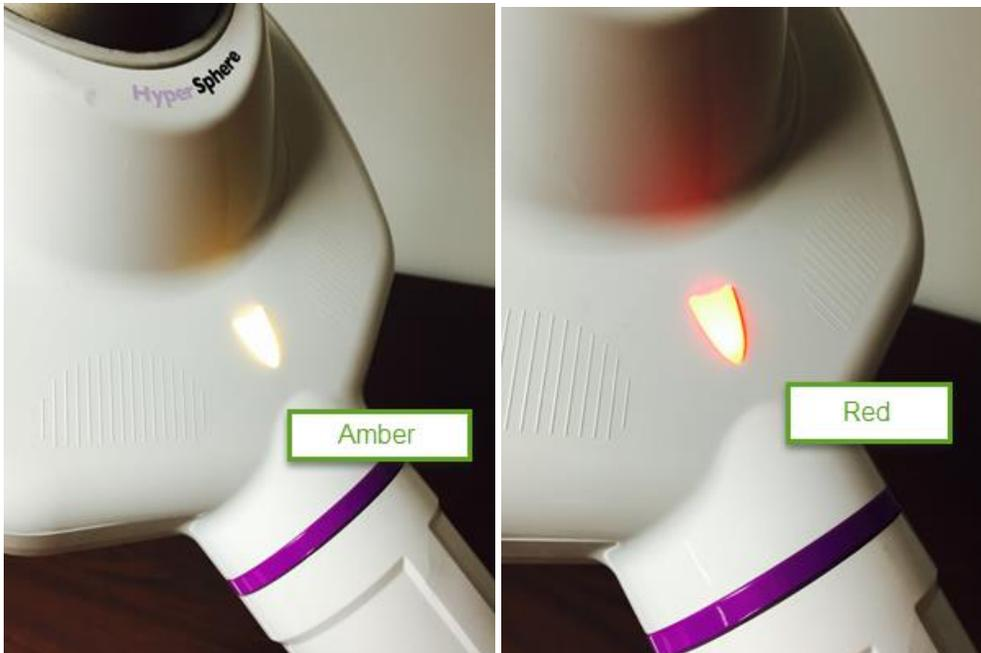

Revolution 4DC Controller Tutorial

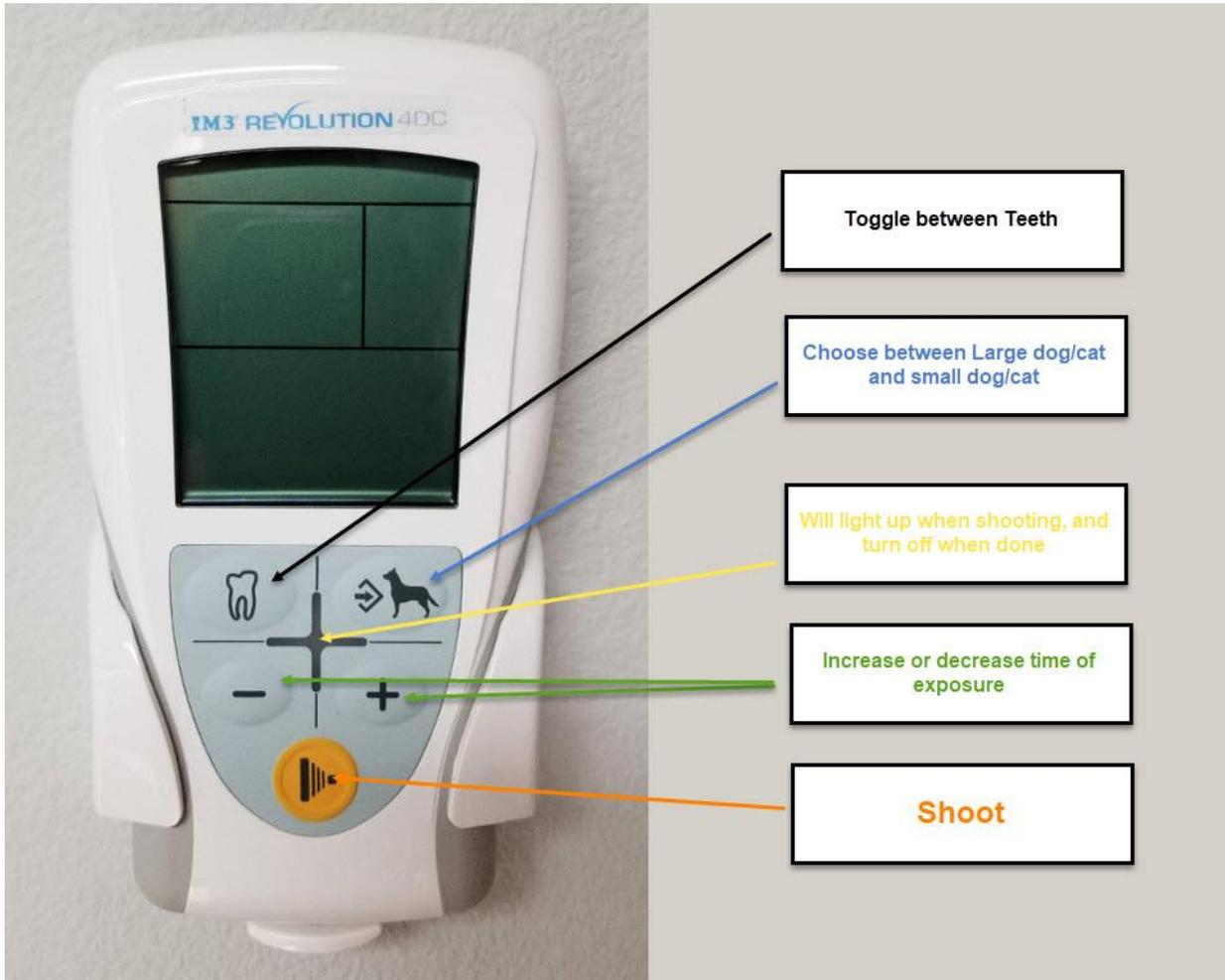

The controller is cordless and runs off 6 radio frequencies. To turn it on, push any button except for the white circle “shoot” button. If the head of the generator is off, the controller will time out after a short period and turn off. It will also time out if the head is on, but it’ll take longer.

To choose your tooth, use the button that has a picture of a tooth. Each tooth has a preset setting. For large dogs, use the large arrow, and for small dogs and cats, use the small arrow. To change between the sizes, push the button that has the image of a dog on it.

The + and – sign will increase or decrease your time.

To shoot, hold the button that’s an orange circle, down through the entire beep. You’ll see the LED light on the front of the head change colors, which is also a good indicator as to when you can let the button go because the xray has completed. If the button has not been held down long enough, you will get an error code on the controller with an E, and the LED light on the head will be red. To reset, push any button except for the shoot button.

Appendix 1: How to Resync Remote to Tube Head

Revolution 4DC Remote Control Sync Instructions

If the remote control or the generator head needs to be replaced it is only necessary to associate the remote control with the head. To do this, you first need to set the head in combination mode (an operation that can be done in two different way) then send a recognition signal from the heads remote control.

1). Setting the head in combination mode:

This procedure can only be activated within ten seconds of the generator unit being turned on.

a). With unit turned off, remove the collimator from the head, then turn on the generator unit. You will hear a beep, wait for a few seconds until the light on the head turns violet, then tap the collimator black microswitch seven times (black microswitch is located inside on right side where base of collimator would be). The head will emit a beep that confirms the head has switched to combination mode and the LED on the head will flash once and stay solid violet.

2). Send the recognition signal from the remote control to the head:

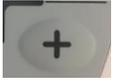
- a). Turn on the remote by pressing 
- b). Hit both  and  to go into menu starting at P01. You have 8 seconds to complete steps below or remote will time out and have to start over.
- c). Hit  until you get to P08.
- d). Once at P08, hit both  and  to go into menu starting at T01.
- e). Hit  to go to T02.
- f). Once at T02, hit . After this, PA01 will display. Wait for a few seconds. You will hear a 5 second beep. If synchronization is successful, unit will restart and display signal bars and “**Ready**” at top of remote.

Appendix 2- Correcting Arm Drift

Correcting Vertical Drift:

To Adjust arm A:

Remove end cap, use 8mm Allen wrench (1) to turn adjustment screw clockwise to increase spring tension (if arm is drifting down) or counter-clockwise to decrease tension (if arm is drifting up).

To Adjust arm B:

Position both arms in vertical position, remove end cap, remove Philips screws (c), and remove upper cover.

Move both arms to horizontal position, loosen Philips screws (d) on each side, and remove lower cover.

Use 8mm Allen wrench (2) to turn adjustment screw clockwise to increase spring tension (if arm is drifting down), or counter clockwise to decrease tension (if arm is drifting up).

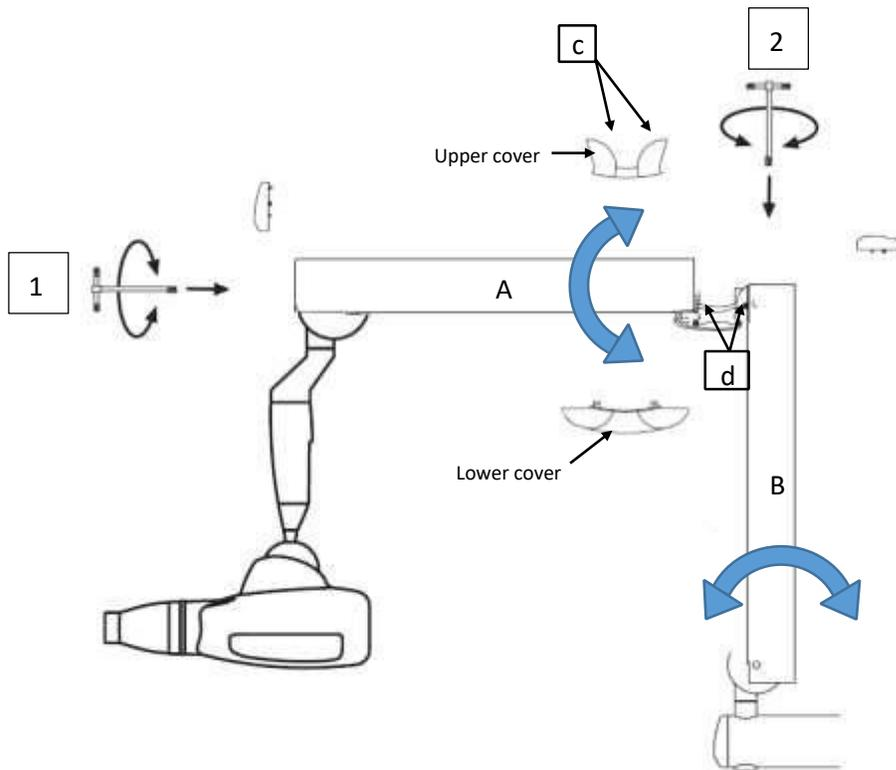

Correcting Horizontal Drift:

Description: Using the 3mm allen wrench, adjust tension on dog head screws to set arm limits to proper limits.



Description: Using 5mm allen wrench, adjust tension on set screw to apply less (counter-clockwise) or more (clockwise) pressure on scissor arm to correct horizontal drifting of arm. If necessary to readjust friction element, use the precision jeweler flat head screwdriver to reposition friction element to vertical position.



Appendix 3: Adjusting Clutch Assembly

Turn the head of the generator vertical (or as much as you can), remove collimator. Next remove the white caps using flat head jeweler screwdriver. Next remove panel stop ring.



Using the 3mm Allen Wrench, remove the screws beneath each white cap.



Appendix 3 Cont.

Work on grub screw A with a 4mm Allen Wrench to adjust the pressure the brake applies on the ball. Make slight adjustment then try engaging touch pads. Repeat a few times. Counter clock wise rotation on Grub A will loosen head if tube head is locked and will not rotate. Clockwise turns on Grub A will tighten tube head if tube head is slipping after touch pads are released. Run the clutch assembly supply wires behind the control card. Close the cover tightening the four fixing screws and put the cover caps back on top of the screws.

If the grub screw A cannot adequately adjust the brake, completely loosen grub screw A, loosen screws B and tighten the entire clutch assembly unit sliding it until it encounters a bit of resistance. Tighten screws B again to prevent turning, making sure the screws match their seats. Adjust grub screw A again and close the cover as previously directed, being careful to lay cable E as shown in the figure below.

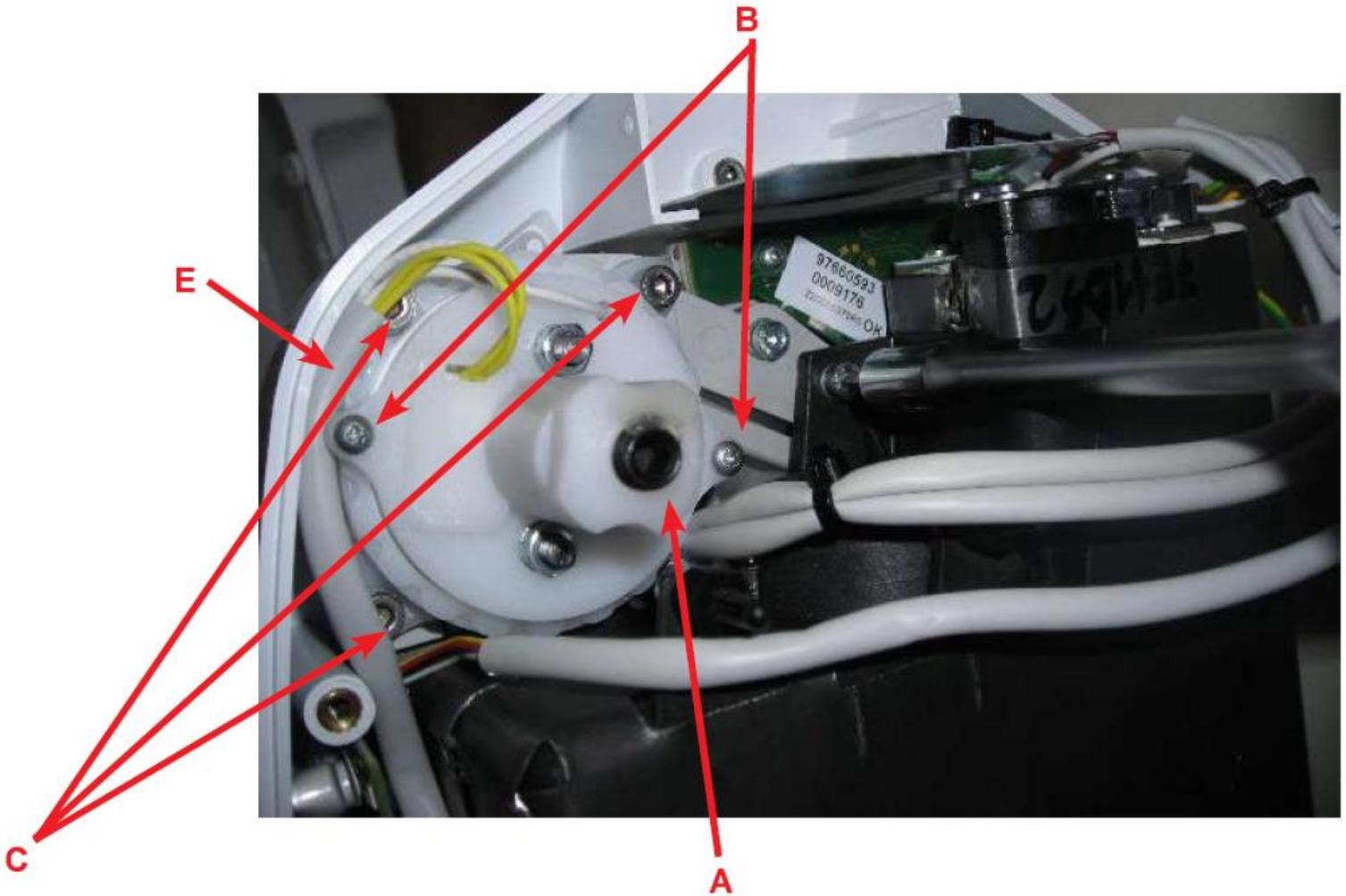

Appendix 4: How to Conduct Calibration Test

7.4 Calibrating the X-ray head

This operation requires the execution of a certain number of shots, at a pre-set time, during which X-ray emission occurs. It is therefore necessary to pay close attention.

Switch on the handheld unit and go to menu T05. To access this menu press  +  keys, scroll the menu using the button  until P08 is displayed, press  +  to access the technical menu and press the  key several times until T05 is displayed, to enter the menu and press again and hold the key to activate the calibration. press the key  to enter the menu and press again and hold the  key to activate the calibration. Perform the shots until the counter reaches 0. Press the  key to quit the menu. Be careful never to release the shot button in advance as, in case of error, it could be necessary to repeat the operation.

Press simultaneously + keys from T05 to set the use of the default calibration values. Press simultaneously  +  keys from T05 to set the use of the default calibration values.

Appendix 5: How to Change WiFi Channel on Remote Control

If the remote control drops connection and resyncs, or you receive an E302 error code message, chances are the remote is having signal interference from other Wi-Fi devices. To change channel on 2.4GHz band, proceed as follows:

Change the Wi-Fi settings

Make sure you have READY status on your handheld. If not, refer to Appendix 1 on how to sync remote to Tube Head:



The handheld allows for a number of work parameters to be viewed and edited by simply pressing a combination of keys present on the control panel.

Key  serves to confirm/save the function, key  is used to undo/quit the menu while keys  and  edit the values of the selected parameters on all the setup menus.

Proceed as directed below to access the menus:

1.  +  Hold down these two keys to go to the setup menu (From P 01 to P 08)
2. Reach P08 with key  and press  + 

You will be able to see the Technical Menu.



3. Reach T06 with key  and press the  button.

Appendix 5 Cont.

4. T06: SELECT WIRELESS CHANNEL

Pressing  and  keys at the same time will enable or disable the icon . If icon is not displayed in T06 menu, please enable this setting. This setting will check whether selected channel is busy and will set to the first free channel available.

To select desired Wireless Channel:

Once you hit  at T06, you will enter Wireless Channel selection menu. Use  or  to toggle through channels. When you are on the desired channel, hit  to save settings. A beep will be heard on Tube head and on remote, then remote will return to T06 Menu screen if successful. If handheld unit displays EE, the procedure was not successfully completed.

Once settings are saved, hit  to back out of Technical Menu and again to back out of Parameters Menu. Wireless Remote will now run on desired channel and remote should display "Ready" with signal bars.