

# User Manual

## ART-P6

Piezoelectric Ultrasonic Scaler

**BONART MEDICAL TECHNOLOGY INC.**

Tel: 909-594-8066

Fax: 909-594-7266

Email: [sales@bonartmed.com](mailto:sales@bonartmed.com)

EU-Authorized  
Representative

Jorgen Kruise A/S  
Marslev Byvej 35, DK-5290,  
Marslev, Denmark

## **COPYRIGHT©2007,BONART ,BONART Co.,Ltd**

BONART MEDICAL TECHNOLOGY INC. owns all rights to this publication. The publication should be used solely for the purpose of reference, operation, maintenance, or repair of BONART equipment. No part of this document may be reproduced or disseminates in any form or by any means, electronically or mechanically ,for other purposes.

In the event of inadvertent or deliberate publication, BONART intends to enforce its rights to this manual under copyright law. No one may copy the materials presented in this manual without the express written permission of BONART MEDICAL TECHNOLOGY INC.

Product specifications, as well as information presented in this manual, are subject to change without prior notice.

**PROPERTY OF BONART MEDICAL TECHNOLOGY INC.  
ALL RIGHTS RESERVED**

**ART-P6 trademarks of BONART Co.,Ltd.**

**Other brands and product names are trademarks or registered trademarks of their respective holders.**

Document No. P41002 Rev.1.0 (06/05)

Printed in Taiwan, R.O.C.

## Operators safety

Read this page carefully before installation and use the instrument.

The instrument described in this manual is designed to be used by properly trained personnel only. Only qualified personnel shall carry out adjustment, maintenance and repair of the equipment.

- NOTE, CAUTION AND WARNING STATEMENTS

**NOTE** : Indicates some tips.

**CAUTION** : Indicate correct operating or maintenance procedures in order to prevent damage to or destruction of the equipment or other property.

**WARNING**: Calls attention to a potential danger that requires correct procedures or practices in order to prevent personal injury.

- SYMBOLS



“BF” symbol , indicate the ART-P6 was manufactured according to the degree of protecting against electric shock for type BF equipment.



Grounding Terminal



Attention, should reading the instructions

Thank you for choosing Bonart piezoelectric scaler. Before using the scaler, please carefully read this User Manual since it contains important information, including installation procedures and operation tips, about the scaler. Especially, please refer to the section "Cleaning and Sterilization" to sterilize the scaler before applying on human subject.

## Warnings

### Important Notes!

The equipment is only to be used by a qualified doctors, dentist,hygienist or other qualified personnel.

A patient with pacemaker cannot be treated with the equipment.

A shielded AC power cord must be used with this equipment.

ART-P6 should be powered from a separate wall outlet with a grounding point.



### **Attention!**

**Avoid use of this machine around Pacemakers.**

It has been shown that electronic appliances including razors, hair dryers, microwave ovens, TV receptors, and some electronic medical equipment, may interfere with the normal operations of pacemakers. It is suggested that patients who have pacemakers avoid treatment with this unit. For further readings on the subject, please refer to:

"Advances in Cardiac Pacemaker", The New York Academy of Sciences, Vol. 167, Article 2, pp. 515-1075

"Electromagnetic Radiation Interference with Cardiac Pacemaker", U. S. Department of Health, Education and Welfare

"The Individual with a Pacemaker in the Dental Environment", Journal of the American Dental Association, Vol. 91, No. 6, pp. 1224-1229

## NOTEs before using:

- The electric power used should be grounded. If this requirement is not met, it could damage the scaler and more importantly harm the user.

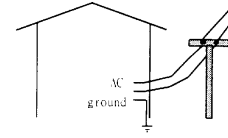

- The machine should be placed on a steady and stable platform or table. Placing the machine on an unsteady, tilted table may degrade the performance and/or may accidentally cause damage to the system.

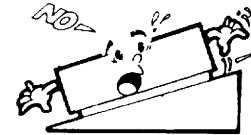

- Do not dismantle the machine on your own or by uncertified technicians. Violation of the requirement may cause harm to the user and/or to the machine.

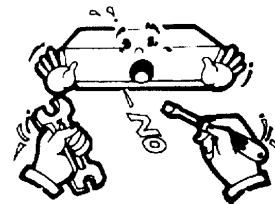

- For electrical safety, the power cord should not be placed under heavy objects, and should also **be kept away from** high temperature heat sources.

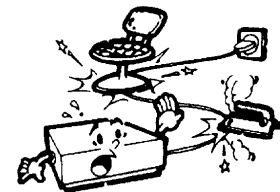

- If you observe any abnormal situations while the machine is in use, unplug the power cord for precaution.

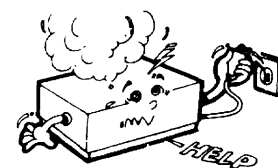

## **Preface**

Piezo Scaler is developed based on the Principle of piezoelectric. Ultrasonic waves are generated in the handpiece by 4 ceramic piezoelectric plates subjected to high frequency alternation current. The Tip is vibrated back and forth in high speed to perform tooth calculus and/or tartar cleaning task. Particularly, the high speed vibrated Tip can remove the toughest calculus and tartar easily, and in conjunction with syringe (or saliva ejector), the scaler can conveniently and swiftly clean teeth and most importantly it is proven to be electrically safe. The electric-mechanical efficiency of this piezoelectric system is much greater than that of traditional magnetostrictive systems. There is very little heat released, and it is possible to work with very little spray. It's sufficient to ensure excellent cavitation but more comfortable for both the patient and the dental surgeon.

The unit is a very powerful apparatus. There are linear scales of power adjustment for removing prostheses and condensing guttapercha. This allows very fine adjustment to suit each clinical situation.

With a large range of Tips, the unit is suitable with different kinds of works.

### **ART-P6**

Operation Modes:

- Operation Frequency: 29 KHz
- Stable and Fine Power Setting
- Various Types of TIP Available
- No Heat Generation of Handpiece

### **Special notes to doctor:**

Since the TIP of scaler is made of stainless steel, avoid direct contact to patient's teeth; it may damage to the enamel of the teeth if not complied. To better utilize all the functions and maximize the performance of the scaler, it is suggested that before using to patients, doctors should practice on models/aluminum plates to familiarize themselves with the usage of the scaler tips, the subtle motion force of the insert, etc.

# Contents

Attention	.....	3
Preface	.....	5
Contents	.....	6
I. Descriptions and Functionalities of Components	.....	7
II. Installation Guide	.....	9
III. Preparation and Practice before the First Use	.....	11
IV. Operation Procedures	.....	13
V. Maintenance	.....	14
VI. Cleaning and Sterilization	.....	16
VII. Accessories	.....	18
Optional Accessories		
VIII. Specifications	.....	19

# I. Descriptions and Functionalities of Components

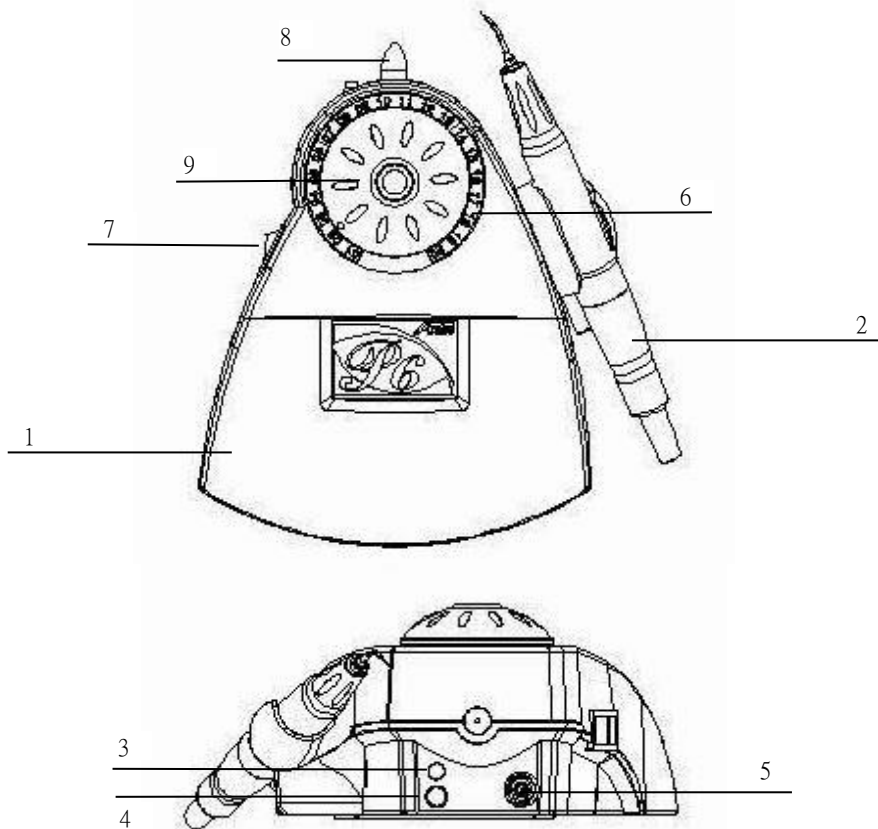

Figure 1. ART-P6 Outlook diagram

## 1. Main Unit

It is the heart of the scaler. Functionally, the main unit generates the needed 29KHz-operation-signal and passes it onto the Handpiece, and thus induces power to vibrate the Tip inside the Handpiece accordingly. Due to pressure variations, a signal from the Handpiece will be fed back to the main unit so that the main unit can track the variation of the loading and adjust the intensity of the controlling signal accordingly.

## 2. Handpiece

The Handpiece consists of vibrator and a Tip. The vibrator is composed of four pieces of piezoelectric plates. It will generate displacement when driven by the electrical signal from the Main Unit. The vibrator will move the Tip back and forth in high speed based on the waveform change of the controlling signal. In addition, the movement of the Tip will induce current on the feedback circuit and the induced signal is then fed back to the Main Unit to complete the control loop. In accordance with the movement of the Tip, a powerful water stream (working like a syringe) will also come out to a)



wash away the tooth calculus and tartar, and b) cool down the temperature of the Tip (heat generated from the vibration of the Tip).  
**Caution: Make sure that new Tip is fully seated.**

### 3. Footswitch

The convenient footswitch helps doctors to easily turn on/off the scaler without interrupting the cleaning process at hands.

### 4. AC Line

### 5. Water Tubing

### 6. Power Panel

User can adjust the 01~20 power level.

### 7. Main Power Switch

Indicating the main power switch. When pushed, the AC power is sent to the Main Unit, and the power indicator (LED) will be lit up. If pushed again, the power is then turned off and the power indicator will be extinguished.



**Before turning the unit on, be sure the footswitch is in the “OFF” position.**

### 8. Water

Indicating the water volume control knob. When turned clockwise, the water volume comes out of the Handpiece will be smaller. On the other hand, if turned counter-clockwise, the water volume will increase. With this water volume control knob, doctors can conveniently adjust water volume based on the operation needs. It is noted that not only washing away the dirt left from the calculus and/or tartar, water here is also used to cool down the temperature of the TIP to avoid overheating. Adjustment of water flow rate controls water temperature. The greater the water flows, the lower the water temperature, vice versa.

**Warning:** Don't adjust water knob in anti-clockwise direction over three circles

### 9. Power

Indicating the output power intensity control knob. When turned clockwise, the output power intensity will be smaller. On the other hand, when turned counter-clockwise, the output power intensity will increase. This power intensity control knob gives doctors the flexibility to adjust the output power intensity based on the difficulty of the cleaning job (e.g., toughness of the calculus).

## II. Installation Guide

### 1. Unpacking

When unpacking the box, check “ART-P6” for any damage. If damaged, please contact your dealer immediately. Enter the unit serial number on your warranty card mail it within 10 days after setting up the machine.

### 2. Storage

- **Environment:**

The unit should be stored in a clean , dry environment. The following environmental limitations apply to both storage and shipping:

Temperature: 0°C to 60°C

Humidity : 10%~90% (at 40°C)

Atmospheric pressure: 860~1060 hPa

### 3. Safety Instructions

#### **A. Grounding:**

Before any connection to the output connectors is made, the unit must be grounded. The mains plug shall be inserted only into a wall socket provided with a protective ground.

**Note: The unit must be positioned so that the plug is accessible.**

#### **B. Main voltage range and fuse:**

Before inserting the main plug into the wall socket, make sure that the scaler is compatible with the local main voltage.

### 4. Setting Up

It is fairly simple to install Bonart Scaler. Just unpack the Bonart Scaler box and connect the components as shown in the figure below.

#### **Note:**

When unpacking the box check “ART-P6” for any damages. If damaged, please contact your dealer immediately. Enter the unit serial number on your warranty card mail it within 10 days after setting up the machine.

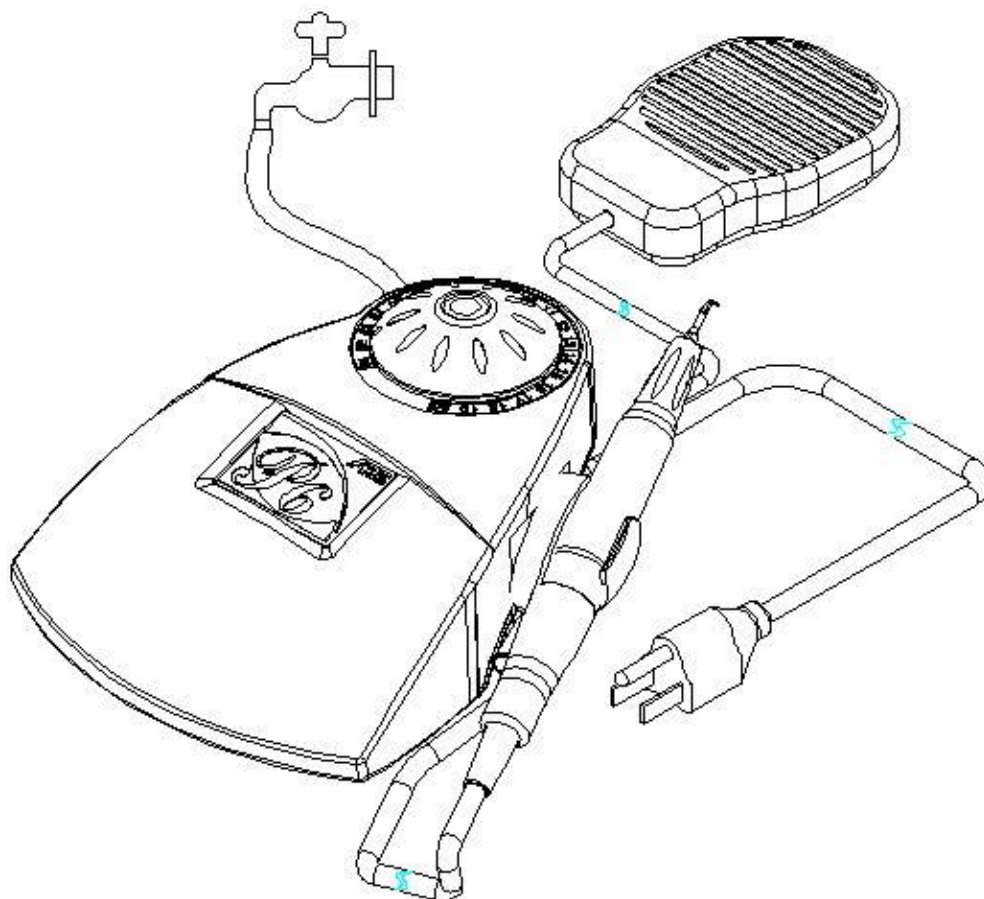

Figure 3. ART-P6 setting up diagram

1. Check "ART-P6" and make sure the both power and power indicator is off when the switch is off.
2. Put the Scaler into a grounded AC power outlet.
3. Choose the correct Tip for desired procedure, and insert it into the handpiece. Make sure the insertion is complete.
4. Make sure the water PU tube is connected well.

**Several installation suggestions are listed below.**

1. Because patients may experience some tissue trauma during the treatment, it is suggested that the operator use purified or distilled water. This will significantly reduce the possibility of infection.
2. After installation, the extra length of the power cord should be neatly arranged to avoid any tripping accidents.
3. The footswitch should be firmly placed at position where the users/doctors can easily access it. Any extra cord to the footswitch should also be neatly arranged to avoid any tripping accidents.

### III. Preparation and Practice before the First Use

To better utilize all the functions and maximize the performance of the Bonart Scaler, it is suggested that before treating patients, users/doctors should practice on models/aluminum plates to familiarize themselves with the system. Maneuver the head of the Tip to make gentle touch on an aluminum plate. Try to familiarize and observe the subtleties of the force strengths under different Tips head angles, positions, etc. Closely examine the scratches left on the aluminum plate after each practice, and try to match each scratch to its originated head position and angle.

In addition, adjust the output power intensity by turning the power knob. Familiarize yourself with the differences when changing the output power intensity. Finally, adjust the water volume by turning the water volume control knob. Familiarize yourself and observe the subtleties among different water volume situations. Observe the temperature of the Handpiece when changing the water volume. Do not overheat the Handpiece. Perform the above practice procedures several times to prepare yourself operating on human subjects.

Belows are some applications and ultrasonic movement of the Tip.

#### A. Tangential application (No. **BS1 TIP**)

Do not apply BS1 Tip directly on the tooth.  
It may damage the enamel. Let the  
hand piece follow a slow and regular movement.

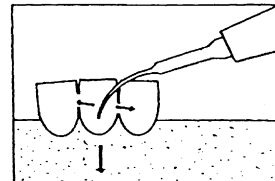
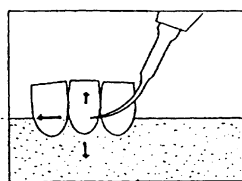
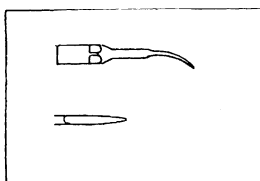
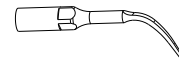

### B. Frontal application (No. **BS2** TIP)

Apply **BS2** tip against the tartar directly, do not against the tooth directly. Put slight pressure for movement

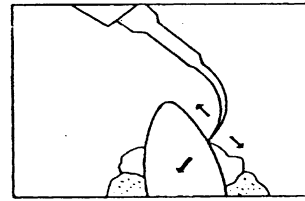
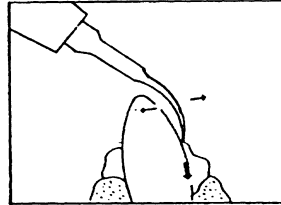
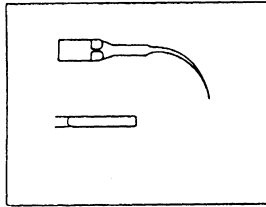

### C. Tangential Application (No. **BS3** TIP)

Contact on the enamel with the rounded tip without pressure when movement.

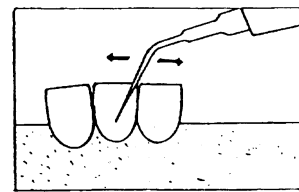
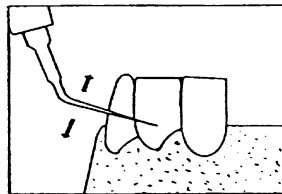
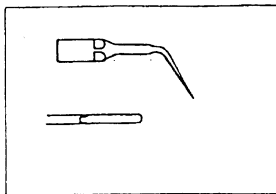
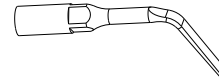

## IV. Operation Procedures

When preparing to treat a patient:

SteP6: Push the POWER SWITCH to light the ON indicator (LED).

SteP6: Check the water.

Step3: Select the needed Tip, make sure it is fully seated with the Handpiece.

Step4: Set the POWER KNOB to the suitable level for the TIP.

Step5: Hold the Handpiece with the Tip end pointing up over a suitable drain. Step on the foot control and allow water to run from the handpiece for a few seconds until it flows without spurting.

**Caution: The above procedure should be repeated each time when an Tip is replaced into the handpiece.**

**Caution: Make sure that the water spray is at the desired temperature and is reaching the working edge of the tip.**

SteP6: Place the tip into the patient's mouth and use the foot control to activate the handpiece and water flow.

When treating a patient:

1. First position the patient comfortably on the patient chair. Adjust the chair angle and/or position so that you can easily access to the patient's oral cavity.
2. Put the saliva ejector into patient's mouth to evacuate away excessive saliva and cleaning remainders.
3. Gently move patient's head so that the oral can be easily accessed with good direction as shown in the figure below.

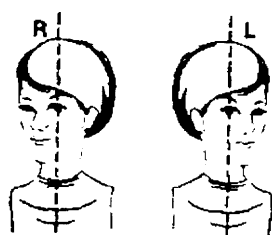

During the treatment, keep the angle between patient's tooth surface and the Handpiece TIP as close to 15 degree as possible. If the patient is not comfortable during the treatment, try the following steps.

- A. When treating place where patient is very sensitive, try to increase the Handpiece movement speed on the surface.
  - B. Treat less sensitive place first, return to sensitive areas later.
  - C. If problem persists, reduce the output power intensity of the Handpiece.
4. Control the handpiece with the foot switch: The Foot control is designed to control the functions of the Handpiece in two ways as below:
- A. With the foot held down on the foot control, the Handpiece is activated and water flows from the Handpiece .
  - B. With the foot control released, both Handpiece and water flow are shut off.
5. Water and Temperature

The WATER KNOB control the volume and temperature of water flowing from the Handpiece by turning the WATER KNOB clockwise or counterwise until the desired rate of flow is obtained.

**Note: The greater the water flow, the cooler the temperature and vice versa.**

**Caution: When operating, a continuous flow of water is required to keep the Handpiece cool.**

## V. Maintenance

The Bonart Scaler does not need special maintenance routines but it does need to be regularly and thoroughly cleaned and sterilized (as described in next section).

### Daily start-up

When starting the unit at the beginning of the day:

- \*Open the water supply shut-off valve.
- \*Push the MAIN POWER SWITCH to light the on indicator (LED)

**Note:** If no water come out, please check the water supply.

**Note:** If power LED does not light, please contact local authorized agent.

### Daily shut-off

When stopping the unit at the end of the day:

- \*Push the POWER SWITCH to turn the unit off.
- \*Turn off the water supply shut-off valve.

### Preparing to treat a patient

- \*Make sure the TIP has been sterilized.

The following suggestions are also useful in extending the product life of the unit.

- A. Place the Main Unit in an open area where air can flow freely around it.
- B. If need to move the Main Unit, handle with care.
- C. Before leaving the operatory, make sure the AC power is turned off and the water faucet is tightly closed.
- D. After six months or if you find the output power of the Handpiece is not enough to perform treatment, it is very possible that the Tip is worn out. If the Tip is worn out, replace it with a new one, otherwise, have your authorized agent service the system.
- E. Customer Service: if service is needed, please contact local authorized agent.

### Trouble shooting

Product requires any maintenance should be returned to the customer service department or authorized service facility. Bonart will repair or replace any product under warranty at no charge.



## VI. Cleaning and Sterilization

In this section, it describes the procedures to clean and sterilize the scaler. It is important to follow these procedures before using the machine; otherwise, patients and/or doctors may have the possibility of getting infection. **It is mandatory that users or the person clean the unit should wear sterilized gloves during these procedures at all time to avoid any possibilities of incomplete sterilization and/or infection.** Below we detail the infection control procedures for the Hand-piece, the Tip, and the Main Unit, respectively.

### Main Unit

Since the Main Unit does not have direct contact with the patients, the cleaning is simple. Just carefully swab the Main Unit with absolute alcohol calomel, and keep it away from dust. (If other detergent is used, choose one that has no chemical effects on the surface of the plastic case of the Main Unit. If not sure, please try it out first.)

### Hand-piece

Before cleaning, remove the Tip from the Hand-piece. Let the Hand-piece run for a couple of seconds to drain out the water and any possible contamination left inside the Hand-piece. The outer surface of the hand-piece should be cleaned with antiseptic soap or solution. Rinsed off with water and wiped or sprayed with a chemical disinfectant that is compatible with the hand-piece material, such as a 1:6 dilute solution of Sporicidin brand disinfectant. A sterile insert or TIP is then reassembled to the hand-piece in preparation for the next patient.

The sterilization procedure when user uses “auto-clave”

- a. Remove the Tip from the hand-piece
- b. Clean the outer surface of the hand-piece by using absolute alcohol calomel or wipe.
- c. Attach the sterilization cup to the bottom of the hand-piece
- d. Put hand-piece into the pouch or other related products, and make sure the pouch is sealed tightly.
- e. Start auto-clave procedure.

**Note:**

Auto-clave condition

121°C/ 250F for 40 minutes and dry out the hand-piece around 20-30 minutes.

134°C/ 278F for 20 minutes and dry out the hand-piece around 20-30 minutes.

**Note:**

It is recommended users or operators should use sterilization pouch no mater during auto-clave or non auto-clave operation.

**Note:**

- Do not use Ultrasonic Cleaner, it will damage the inner components of the hand-piece
- After each usage, let the Hand-piece run for couple seconds to drain out the water and any possible contamination left inside the Hand-piece.
- Auto-clave will shorten the usage life for inner components of hand-piece. It's important to attach the sterilization cup.

**Warning:**

- Do not put the Hand-piece and the extension wire directly into the sterilized fluid. Any such fluid left inside the machine will interfere with the normal operations of the system. After each sterilization, it is recommended to wipe the surface of the hand-piece by using water.
- Do not try to open the hand-piece. The design of hand-piece is precise and sensitive. Any attempt to open it will shorten the life of the hand-piece.
- The chemical disinfectant should not be allowed to remain on the surface longer than the recommended time or material damage may result.
- Cleaning of the Hand-piece is strongly suggested after each patient use.

**Tip**

After each usage, there will be saliva and/or blood or other debris left on the Tip, consequently, it is necessary to clean the Tip with a supersonic cleaner first. This can be done manually by scrubbing it with a brush or by use of an ultrasonic cleaner with a solution of detergent and water. After scrubbing, the Tip should be rinsed thoroughly with water to remove all detergent. Then dry rinsed the Tip. Finally, put the Tip in a bag and then put it into a medical-equipment autoclave and sterilize the Tips at 260°F(127°C) for 30 minutes or as recommended by the manufacturer of the particular sterilizer used.

An alternative, but less desirable method of sterilization is the use of a compatible chemical sterilant such as Sporidicin brand disinfectant. In this method, the Tip is immersed at room conditions in the disinfectant at the appropriate strength and for the recommended period by the manufacturer. Finally, thoroughly rinse with sterile water and have it dried completely.

**Note:**

Auto-clave condition

121°C / 250F for 40 minutes and dry out the hand-piece around 20-30 minutes.  
134°C / 278F for 20 minutes and dry out the hand-piece around 20-30 minutes.

**Note:**

- If the Tip already worn out over 2 mm, please purchase a new one from your local dealer to avoid any affection of vibration.
- Normally worn out or because of unexpected event to cause, please purchase a new replacement.

**Warning:**

- High room temperature conditions, improper dilutions, or excessive immersion time in a chemical sterilant can result in damage to the plastic and elastomeric materials of the Tips.
- Do not try to bend or change the shape of Tip, it may affect the output power.
- Please do allow Tip to have direct contact with other metal material while sterilization. The electrolysis situation may damage the Tip. To avoid this kind of damage, it is recommended that Tip should be put into the pouch or related products.

## VII. Accessories

(1) PU Water Tubing x1

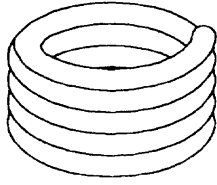

(2) Wrench Set x1

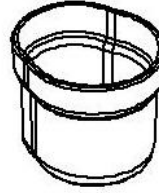

(3) Piezo Handpiece x1

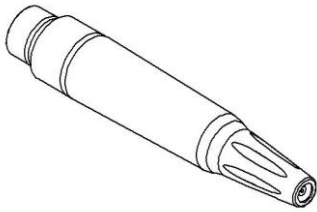

(4) No.1/2/3 TIP x1

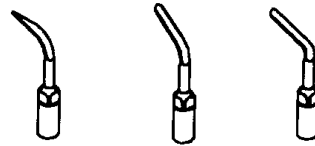

- **Optional Accessories**

Endo Tip

## VIII. Specifications

BONART ART-P6 scaler is designed and manufactured to meet the most demanding environment. It's specifications are listed below

### ● **Classifications**

- Type of protection against electric shock : Class I
- Degree of protection against electric shock : Type BF
- Degree of protection against the harmful ingress of water : IP40
- Mode of operation : Continuous
- According to medical device directive : IIa

### ● **Complies to following Directive/Standards**

ISO13485 - Medical devices - Quality Management Systems requirements for regulatory purposes

93/42/EEC – MDD CE directive

EN60601-1: Medical Electrical Equipment , General Requirement for Safety

EN60601-1-2: Medical Electrical Equipment , Electromagnetic Compatibility Requirements and Tests

EN55011: Limits and methods of measurement of Radio Disturbance Characteristics of Industrial ,Scientific and Medical (ISM) Radio Frequency Equipment

### ● **Specification**

Power supply	115V $\pm$ 5% ~50/60Hz 28VA
	230V $\pm$ 5% ~50/60Hz 28VA
Working frequency	26KHz ~ 32KHz
Water supply	25~60 PSIG(172~414KPa)
Dimension	19.5cm(L) x 16.2cm(W) x 8.3cm(H)
Weight	1.6 Kg(include handpiece)
Handpiece Cable	250 cm
Footswitch Cable	250 cm
Operation environment	
Temperature	0°C~60°C
Relative Humidity	10% ~ 90% (non-condensing)
Transport and storage conditions	
Temperature	0°C~60°C
Relative Humidity	10% ~ 90% (non-condensing)
Atmospheric pressure	860~1060 hPa