



GS Deluxe LED Dental System Manual



iM3 - The veterinary Dental Company

iM3 Inc
12119 NE 99th Street Suite 2060
Vancouver WA 98682 USA
Tel (360) 254 2981 Fax (360) 254 2940

iM3 Pty Ltd
9/31-33 Chaplin Drive
Lane Cove NSW 2066 Australia
Tel (02) 9420 5766 Fax: (02) 9420 5677

www.im3vet.com

April 2010

TABLE OF CONTENTS

Table of contents	2
iM3 Unique Design Features.....	3
iM3 GS Deluxe Control Panel Guide.....	4
Rear of iM3 GS Deluxe & Ultrasonic Scaler coolant outlet.....	5
Getting Started	6-7
iM3 Distilled Water and CLS Enviro Solution Supply.....	8
iM3 Filtration System.....	9
3 Way Air Water Syringe.....	10
iM3 Advantage Low Speed Handpiece and attachments	11-13
iM3 Advantage LED High Speed Handpiece	14
iM3 Dental System Bur Kits and Rodent Kits.....	15
Handpiece Pressure Adjustment.....	16
Handpiece Lubrication	17
Handpiece Sterilization	18
Handpiece Maintenance.....	19
Silent Hurricane Oil Free Compressor	
Operating Instructions.....	20
Identifying Air Leaks.....	20
Compressor Component Details.....	21
Adjusting Regulator Pressure.....	22
Silent Hurricane Compressor Maintenance.....	23
Trouble Shooting;	
Cartridge Toggle switches	24
High Speed Handpiece	24
Low Speed Handpiece	25

iM3 Operator Safety

Im3 Dental equipment should be operated by a qualified person—for animal use only

For operator safety, it is recommended that safety goggles
or visor, face mask and surgical gloves be worn
during all procedures.



Visit Our Web Site: www.im3vet.com

Unique Design Features

iM3 Dental Systems are designed with unique and practical features to make your work even more satisfying and productive. Please note; some features listed below, may be optional depending on the system you purchase.

Control Top

The Corian® top is a non-porous work surface which is easy to sanitize. It incorporates a groove around the edge to prevent burs falling on the floor during procedures. The control box is made from powder coated aluminum that won't warp or deteriorate with age.

Color Coded System

All supply lines on iM3 dental systems are color coded to simplify service and maintenance requirements.

Maintenance Instructions

All maintenance instructions are conveniently printed on the card hanging from the unit, or printed on the back of the dental machine ensuring the system is kept in perfect working order.

Power Board

A four socket electric power board is conveniently located on the side of the control panel, featuring an IEC female socket. (Optional on the GS, standard on the Deluxe)

Adjustable Stainless Steel Stand

The iM3 stand is made from high quality stainless steel and is height adjustable for work and ease of storage. (Optional on the GS, standard on the Deluxe)

Wall Arm

An air operated approx 54"/1.50m long arm is available

Ultrasonic Scaler Coolant Outlet

The ultrasonic scaler coolant outlet is mounted conveniently on the rear of the control box, to allow the use of the water or system to supply the coolant to your ultrasonic dental scaler.

CLS Enviro System

CLS Enviro System is an ingenious occupational health and patient safety system. CLS is designed to help reduce the risk of atmospheric pollution and the transfer of viruses, such as FIV from patient to patient and reduce unpleasant mouth odors.

LED Advantage High Speed Handpiece

The self-generated LED provides daylight-quality, neutrally-coloured white light at 22,000 Lux. Patented Hygiene system, prevents the suck back of aerosols and micro-particles into the turbine. LED's offer a robust, long lasting Light source that barely heat up, are shock resistant and that do not emit any harmful IR and UVA rays.

Particle Filters and Bacterial Filters

Particle filters and bacterial filters are installed on all iM3 dental systems to help reduce particles entering the water supply and reduce unpleasant environmental odors from the HP exhaust collection bottles.

Oil Free Silent Hurricane Compressor

Mounts underneath the unit on the stainless steel stand—supplying air wherever the unit is to be used, and is considered more convenient than a noisy compressor which is usually situated in another room and requires a length of air line. iM3's has produced an Oil free compressor - low maintenance, oil free air.

iM3 GS Deluxe Control Panel

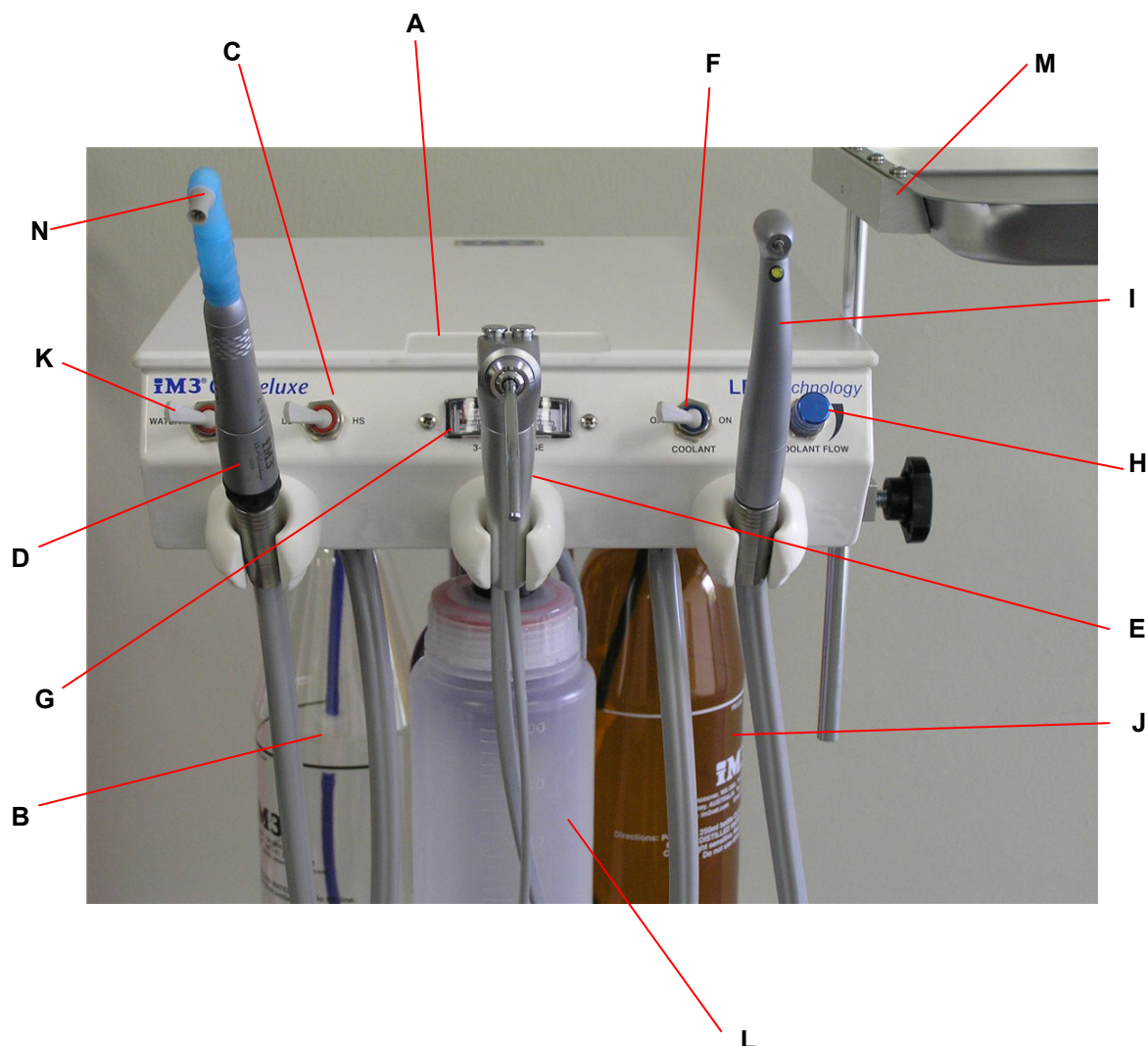

- (A) Corian ® work surface with recessed magnetized bur holder, to prevent burs falling on the floor.
- (B) Clear coolant reservoir with particle filter.
- (C) Handpiece Selector switch for the selection of low speed or High Speed Handpiece.
- (D) Low Speed Handpiece – used for polishing, and low speed cutting – 20,000 RPM.
- (E) 3 way syringe – air, water, or mist when both buttons are pressed together.
- (F) Coolant bottle pressure switch.
- (G) Pressure gauge for setting handpiece pressure.
- (H) Coolant Flow Control – regulates the amount of liquid to the high speed bur.
- (I) LED Advantage High Speed Handpiece – for high speed cutting.
- (J) The amber bottle allows the use of CLS, which is light sensitive (contains chlorhexidine)
- (K) Water/CLS option selector toggle.
- (L) Exhaust air bottle for High and Low speed handpieces - do not fill with water.
- (M) Height adjustable Stainless Steel instrument tray
- (N) iM3 R&R oscillating prophyl angle L7465

Maintenance Instructions are printed on the back of the machine.

Choice of Stand – Wall mounted air activated arm, Stainless Steel Height adjustable stand and Stainless Steel Height adjustable Stand with iM3 silent hurricane oil free compressor.

REAR OF iM3 GS Deluxe

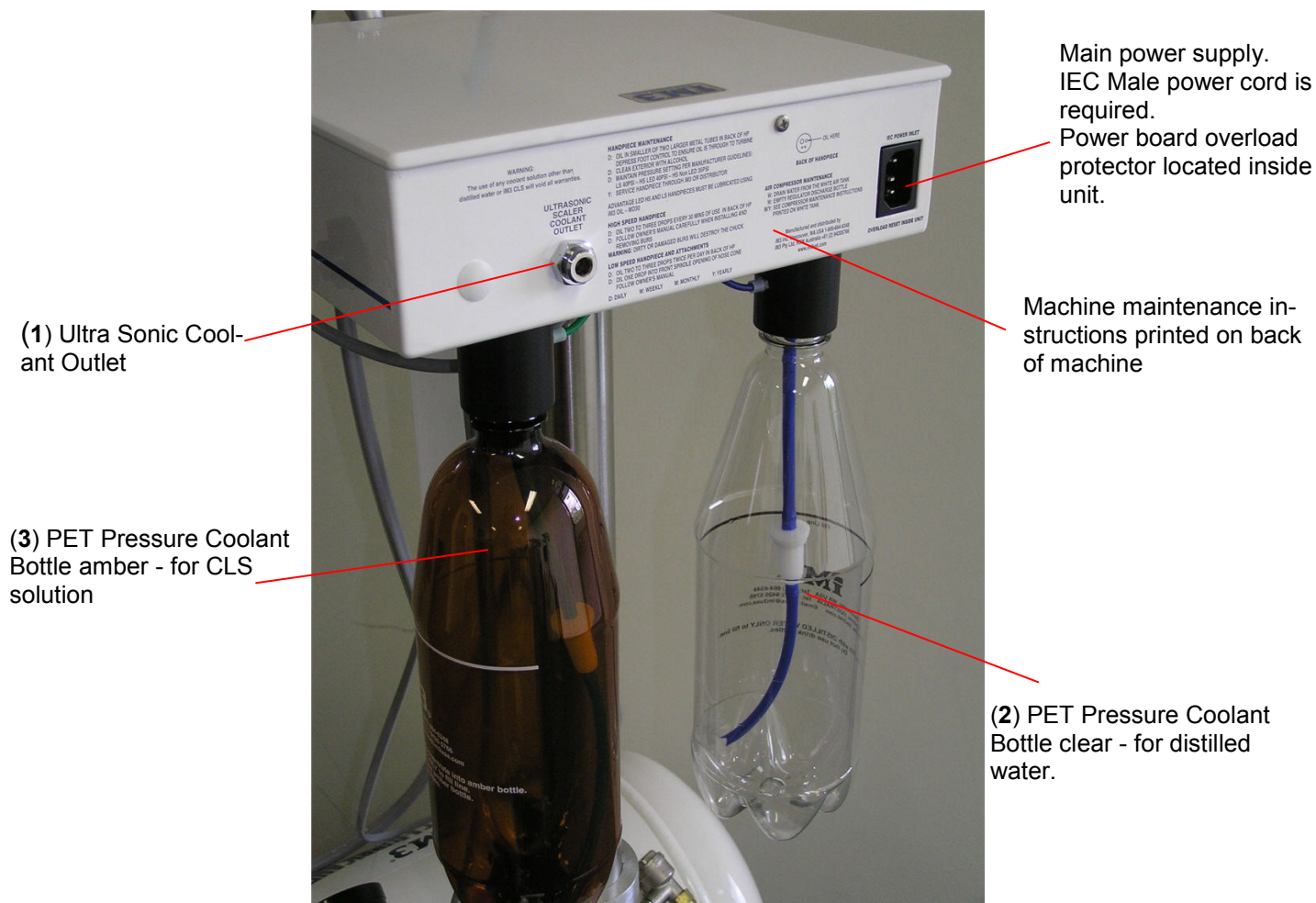

(1) Ultra Sonic Coolant Outlet

(3) PET Pressure Coolant Bottle amber - for CLS solution

Main power supply. IEC Male power cord is required. Power board overload protector located inside unit.

Machine maintenance instructions printed on back of machine

(2) PET Pressure Coolant Bottle clear - for distilled water.

With the coolant bottle pressure switch (F - Page 4) in the "ON" position, the bottle will be pressurized to 35PSI (approx. 2.5 bar) to supply water/CLS to the 3 way syringe and the High Speed Handpiece. It must be switched to the off position to release the pressure before re filling the bottle.

(1) Ultra Sonic Coolant outlet – This will supply pressurized water/CLS to your ultrasonic dental scaler – A male fitting can be supplied by iM3 for your ultrasonic scaler water line. DO NOT use any coolant other than distilled water or CLS – any other solution may cause a blockage and will void your warranty.

(2) A clear PET pressure bottle is supplied, a used soft drink bottle may be used in an emergency situation, a new un-used bottle from iM3 is recommended to avoid splitting if using a pre used bottle.

(3) Amber coolant bottle for the use of CLS in the GS Deluxe. The user can switch between water and CLS (page 5 (L)).



Getting Started

1. Attach all four castor wheels to the stainless steel base.
2. Loosen the stand height adjustment knob and lift the dental control box to working height. Tighten the stand height adjustment knob to secure.
3. Screw on the high speed handpiece and low speed waste collection container under the control panel, located behind the 3 way syringe grey cabling. (picture P.4)
4. Fill the clear plastic water bottle at the back of the machine with distilled water and screw into the holder with the blue tubing, **Do not over tighten.**
5. Fill the amber plastic bottle with the CLS Concentrate Solution (8.5oz or 250 ml) and dilute with distilled water (25.4oz or 750ml) to make a 33.82 oz or 1 litre solution. Screw the bottle into the holder with the green tubing. **Do not over tighten.**
6. Place the 3 way air/water syringe in its handpiece holder—center position.
7. Connect the handpieces by screwing them to the grey handpiece line (see picture below) and place in correct handpiece holder labeled on the dental system. Page 4 (D) and (I)

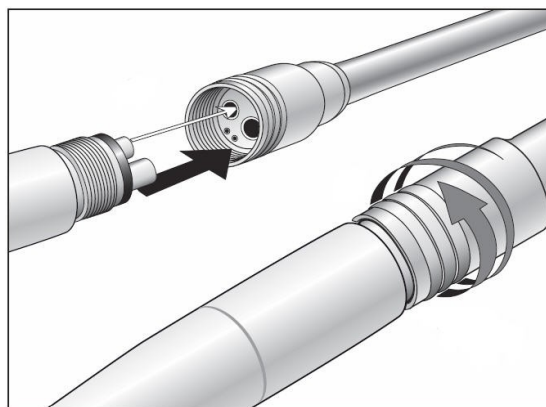

8. Check the main dental machine air line (grey in colour) is connected to the quick disconnect fitting on the compressor outlet tap (on/off) (See page 23)
9. Plug the unit into an electrical outlet with power cord supplied and turn power board ON. (see page 5)



Getting Started

11. Turn on the compressor and allow to pressurize, (see page 21.)
12. Make sure your compressor is set to deliver the correct working pressure. The air pressure regulator gauge should read 80 psi (5.5Bar). If adjustment is required, please see page 27 for compressor pressure adjustment instructions. The pressure is set at the iM3 factory.
13. Place the foot control pedal on the floor in front of the unit. The foot pedal operates the High and Low speed handpieces when depressed.
14. Check handpiece operation:
 - a) Select **HS** on the Toggle, Remove High Speed Handpiece from holder and depress handpiece foot control pedal—handpiece should now operate. Page 4 (C)
 - b) Select **LS** and Remove Low Speed Handpiece from holder and depress handpiece foot control pedal—handpiece should now operate. Page 4 (C)
15. Adjust individual handpiece pressure if required, (see page 16). Each handpiece—Low speed and high speed has a specific pressure requirement.
16. Pressurize water system by selecting the coolant bottle pressure switch to ON, located on the front of the control panel. (see page 4 F)
Important. When filling distilled water and/or CLS Enviro bottles de-pressurize the water system, by switching the coolant bottle pressure switch to off. Check water and air supply to the 3 way air water syringe. Depress the right hand button for air and left hand button for water or both together for a mist.
17. Water volume. Remove high speed handpiece, from holder and depress foot control pedal. Adjust water spray volume to a fine mist by rotating the flow control knob. (see page 4 “H”)

Please observe manufacturers handpiece maintenance instructions for handpiece longevity.

iM3 Distilled Water and CLS Enviro Solution Supply

Each iM3 dental system is supplied with an amber and clear water bottle which should be filled only with distilled water to assist in preventing mineral or bacteria build up in the handpieces. This water bottle supplies the high speed handpieces, 3 way air water syringe and ultra sonic scaler coolant outlet .

The CLS Enviro Solution supply and water system allows you to choose between distilled water or CLS Solution at the flick of a switch, depending on the dental procedure you wish to perform. The CLS solution contains chlorhexidine which is light sensitive and should be kept in the amber bottle provided.

The coolant system for your iM3 dental system, has been preset at 25 psi.

Refilling Coolant Bottles

To refill the distilled water or CLS solution, flip the coolant pressure switch (p. 4 F) on your dental system to OFF - depressurizing the system. After the system has been depressurized, unscrew the bottle and refill with either distilled water or CLS Solution. After filling the coolant bottle screw it back into the holder and flip the coolant switch to ON, repressurizing the system.

DO NOT OVERTIGHTEN THE BOTTLES.

Please Note: When the day's dental procedures are complete, flip the ON/OFF coolant switch to the OFF position, depressurizing the coolant bottles for storage.

Here's what Dr Jeanie Hawkins, DVM, Diplomat AVDC had to say about CLS Solution and the Auto Flush System.....

"Having CLS Solution at my fingertips to flush periodontal pockets is a real plus. iM3® is the only Company to address the problem of cleaning the airlines and high speed handpieces."



iM3 CLS solution 250ml - Ordering Code C3130

iM3 Filtration System

Water and CLS Enviro Solution Supply

Inline filters in the supply bottles help prevent particles from entering the system and blocking handpieces. These filters are located in the distilled water and CLS Enviro bottles.

The inline filters will need to be checked and replaced if they appear dirty.

The use of distilled water is mandatory in the water bottles, as local water may clog the system and can corrode the brass valves in the system, apart from the risk of a bacterial build up.

Note: Failure to use distilled water will void the iM3 machine warranty.



iM3 Hygiene head system

The turbine in most high speed handpieces continues to revolve for a few seconds after use and acts as a miniature centrifugal pump, sucking back air and water containing mouth viruses and bacteria into the head of the handpiece.

The unique patented design of the iM3 Advantage LED HS handpiece prevents this taking place.

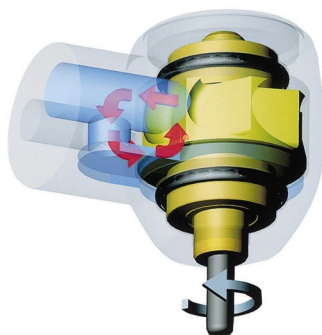

iM3 Advantage Turbine for High Speed Handpiece L5500

Note: The use of other chlorhexidine solutions may cause crystal deposits in handpieces and valves. Use of such solutions will void the warranty. Do not dilute CLS beyond the recommended label instructions, as it may result in crystal deposits forming and block handpieces and valves. Chlorine in water will cause chlorhexidine to flocculate—use only distilled water.

3 Way Air/Water Syringe

Right-hand button for air (a) and the left-hand button for water (b) and both for a fine mist (a & b).

The 3 Way Syringe is ideal for flushing away debris during prophylaxis or drying areas during endodontic procedures.

Tip Removal

The tip of the 3 Way Syringe may be removed for cleaning and autoclaving.

Simply depress the outer ring housing (c) and remove the tip. (See diagram below).

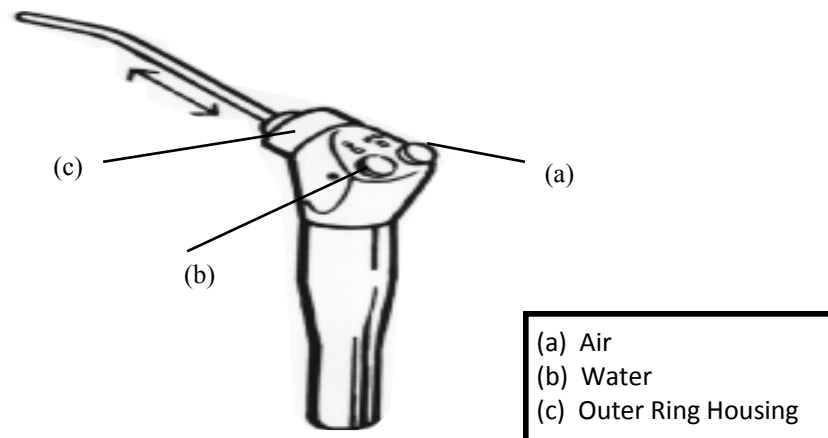

Ultrasonic Scaler Coolant Outlet

The Ultra Sonic coolant outlet is located on the back of the control box. Page 5

This outlet provides coolant under pressure for an ultrasonic scaler. Water or CLS can be selected on the GS Deluxe.

iM3 Advantage Low Speed Handpiece L6200

The low speed handpiece features include a light weight balanced profile and smooth swivel action. Its vane type power system is quiet and vibration free. The motor accommodates both doriot or ISO heads and its powerful torque is suitable for all low speed procedures. The Low speed Motor operates at 20,000 RPM with delivery pressure of 40 psi.



Operation Recommendations

- Air pressure** The dental unit air pressure should be adjusted to be 40 psi See page 16
- Lubrication** To assure optimal performance and life the handpiece should be lubricated daily with MD-30 oil lubricant. Instructions for lubrication are found on page 20.
- Air supply** Moist or dirty air from the compressor can cause damage. Check the regulator filter regularly. If dirt or moisture is present, replace the regulator filter and bleed the system, to remove water or oil.

Installation Instructions

1. Preset the air pressure to 40 psi (see page 16)
1. Connect the low speed handpiece to the grey handpiece line
2. Fit the 4:1 Advantage straight nose cone. Attach the Blue R&R oscillating prophyl head
3. Depress the foot control fully to operate the low speed handpiece

Note: Polishing should be carried out at 5,000 rpm or less. This can be accomplished by running the motor at full revs (20,000 Rpm) and use a 4:1 reduction head, to achieve 5,000 revs, maintaining torque.

iM3 Low Speed Handpiece Attachments

(1) 4:1 Advantage Straight Nose Cone Attachment L6250

The reducing head is designed for polishing (prophy). The speed of the polishing cup should be maintained at less than 5,000 r.p.m. The reducing attachment therefore allows the motor speed and torque to be maintained while reducing the polishing speed. iM3 disposable oscillating prophy angles are fitted to the SNC. They won't trap muzzle hair, or generate excessive heat.

(iM3 R&R prophy cup Code L7465)



(2) 1:1 Straight Nose Cone Attachment Blue Band

For (HP burs) and the use with the iM3 rodent kit. This includes a soft tissue protector with diamond bur and diamond disc.



(3) Diamond Saw Attachment

This saw blade may be single or double sided and operates in the 1:1 attachment blue band straight nose cone on the low speed handpiece. It should always be used with a guard.



(4) Prophylaxis Paste

iM3 recommends the use of iM3 R&R individual tub prophylaxis paste. The paste contains no fluoride or flavor oils. It is a medium grit suitable for use with the R&R prophylaxis cups.



Advantage Low Speed Motor and 4:1 straight Nose Cone

See operating instructions supplied with iM3 low speed handpiece

Fitting R&R Prophy Cups (L7465)

Place the R&R prophy angle over the chuck housing on the 4:1 SNC making sure the slot in the R&R lines up with the small screw in the side of the chuck housing.

See picture to right.

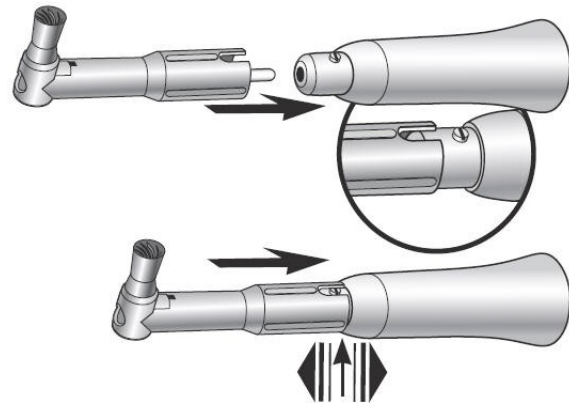

High Speed Handpiece

LED Advantage HS HP L5200



Push Button

The High Speed Handpiece is designed to operate at a pressure of 40 psi at the handpiece and at speeds of up to 350,000 rpm. A very light touch is necessary as handpieces operate with very low torque and high speed. Pressure on the handpiece of 30gms (1ounce) or more, will cause the bur to stall.

Note: All handpieces should be lubricated prior to use with iM3 MD-30

Bur Replacement - Push Button

1. Activate the press button and at the same time insert the bur until it reaches the limit stop
2. Check secure location by applying slight axial tension.
3. Remove the bur by pushing the pres button.

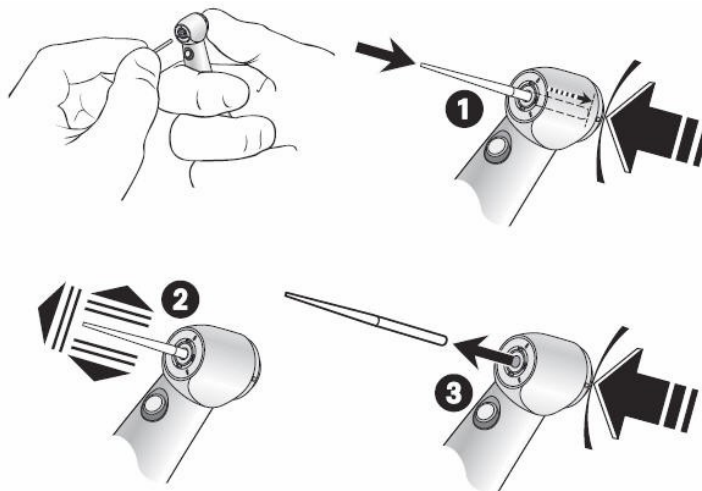

!!! WARNING !!!

Read Operating Manual supplied with Handpiece before using.

iM3 Dental Systems

iM3 Autoclavable Bur Kits

There are three Bur Kits in the iM3 range, the F.G. Dog (Friction Grip), F.G. Cat and H.P. (Handpiece Burs). Each kit contains 10 burs of various sizes and applications. Each bur has been selected by a specialist Veterinary Dentist. iM3 Bur Kits come complete with a laminated suggested application guide. Each bur holder carries individual re-order codes and can be ordered in packs of five. The blue holder is autoclavable and prevents the burs from falling out.



Feline FG Bur kit
(Order code) D7530



Canine FG Bur kit
(Order code) D7510



HP Bur kit
(Order code) D7540
44.5mm long

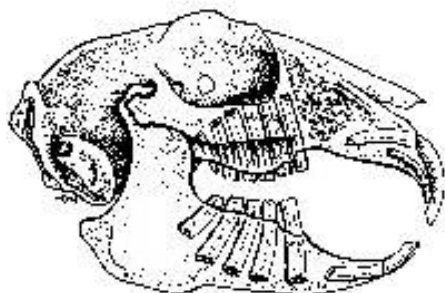

The iM3 Rabbit/Rodent Soft tissue kit comes complete with Long diamond bur and soft tissue protector and diamond disc with safety shield. Complete Kit (optional)
Code: D2245

The soft tissue kit should be used on an iM3 1:1 straight nose cone - Blue

iM3 Handpiece Pressure Adjustment

Handpiece Pressure Adjustment

Both the High Speed and Low speed handpiece should be set to a specific pressure. The Handpiece pressure adjustment is located underneath the dental machine behind the grey tubing for each handpiece. The adjustment knob is a small silver knurled knob (see picture below).

Turn your unit on and select the Handpiece (high or low speed) to be adjusted, remove the handpiece and depress the foot pedal to operate the handpiece. Turn the adjustment knob until the desired pressure is displayed on the handpiece pressure gauge picture 2 below.

Low speed hand-
piece holder

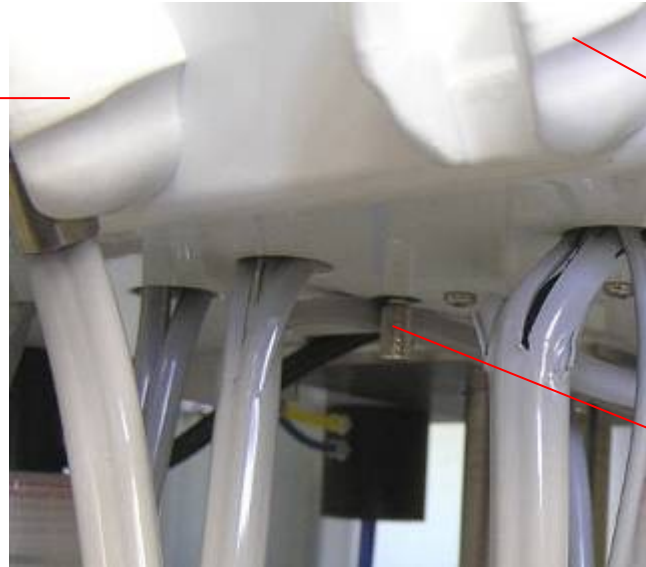

3 way syringe
holder

Low speed pressure
adjuster

**PRESSURE IS READ
ON THE HANDPIECE
PRESSURE GAUGE**

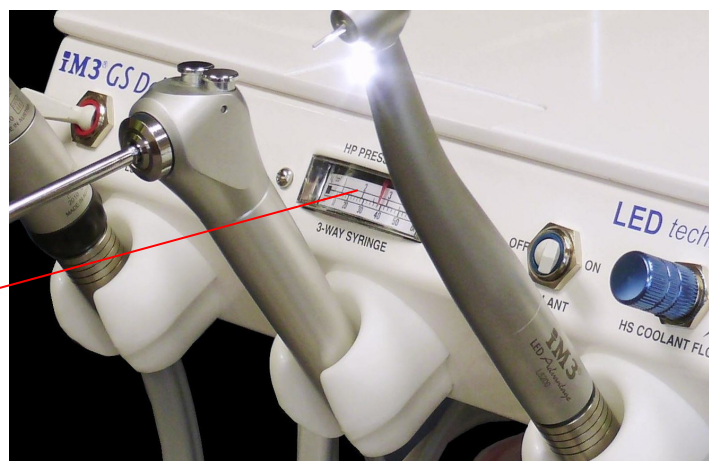

Low Speed Handpiece

40 p.s.i. - Pre set by iM3

High Speed Handpiece

40 p.s.i. Pre set by iM3

NOTE: if the desired Handpiece pressure cant be achieved check that the pressure on the Compressor Regulator is set at 70 - 80 p.s.i. or 5 BAR.

iM3 Dental Systems

Lubrication of HS & LS Handpieces L5200 & L6200

Refer to separate handpiece manual.

All handpieces should be lubricated regularly. We recommend the use of MD-30 handpiece oil before use and after 30 minutes of running time. The foot pedal should be depressed for 5-10 seconds after oiling to ensure the lubricant will reach the turbines and working portions of the handpiece.

The lubricant is placed in the smaller of the 2 large holes.
“Air entry hole” at the base of the handpiece.



**Maintenance instructions are printed on
the back of the dental machine**

NOTE:

**DON'T FORGET TO DEPRESS
THE FOOT CONTROL AFTER
OILING TO ENSURE LUBRICANT
REACHES THE TURBINES.**



Sterilization

Refer to handpiece operating manual.

HIGH SPEED HANDPIECE

Handpieces should be thoroughly cleaned to remove any foreign particles, eg; blood, saliva etc. Make sure that the turbine cartridge and head cavity are clean before autoclaving. If autoclaved with bloody particles in the turbine housing, autoclaving will cause particles to be scorched and damage to the turbine may result.

The exterior of the handpiece may be cleaned with any good surgical disinfectant. Be sure to rinse and dry thoroughly. Lubricate handpiece turbine with MD-30 Lubricant.

Refer to handpiece operating manual.

LOW SPEED HANDPIECE

Prepare handpiece and attachments for sterilization by carefully cleaning the exterior surface. Thoroughly scrub, rinse and clean away any residual solution and particles. Remove moisture with a towel or use air from the 3 way air water syringe.

1. Prior to sterilization, lubricate the handpiece using MD-30 Lubricant.

HANDPIECES: Apply oil through the handpiece air inlet tube. (see page 17)

ATTACHMENT: Remove attachment from handpiece and oil through both end openings.

Note: *After lubricating items, assemble and operate for a few seconds to expel excess lubricant.*

2. Seal items in sterilization tubing bags. Make sure to remove bur from handpiece prior to sealing.
3. Place handpiece or attachments in sterilization trays of dry heat sterilizer or steam autoclave. Do not exceed temperatures of 275°F or 135°C. Sterilize according to manufacturers instructions.
4. After sterilization cycle is completed, allow handpieces and attachments to cool down then lubricate handpiece and attachments thoroughly. Make sure to use a different container after sterilization cycle, to prevent recontaminating.

Note: Lubricate handpieces using MD-30 Lubricant after cooling down, do not allow handpiece to sit in sealing bag overnight or for a long period. Immediately operate handpiece as described in the following step.

5. After lubricating items, insert bur into handpieces and operate for a few seconds to remove excess lubricant.

Do not autoclave the high speed handpiece with a bur in the chuck.

Handpiece Maintenance

All Handpieces have a working life which can be extended by maintaining the correct operating pressures and speeds as well as adequate lubrication.

The working life of most Handpieces turbines is 12-24 months, however, this will depend upon the degree of care taken and the amount of use.

Preventative maintenance will ensure a working Handpiece at all times.

Handpiece	Daily	Weekly	Monthly	Yearly
iM3 Low Speed Handpiece Oil in smaller of 2 big holes. Depress the foot pedal for 10 seconds to ensure the oil reaches the Turbine (page 17)	Oil AM or PM before or after use. 2-3 drops Use iM3 MD-30 Lubricant.			Replace turbine and 'o' rings and sealing gasket. If worn
iM3 High Speed Handpiece as per the instructions for the Low speed above. Page 17.	Oil AM or PM before or after use. 2-3 drops Oil with MD-30 Lubricant.			Replace turbine and 'o' rings and sealing gasket. If worn
Prophy Head R&R Oscillating	Dispose of prophy head between patients to prevent cross contamination			

Silent Hurricane Compressor

Oil Free

The compressor is perhaps the most crucial part of any dental system as it supplies the valuable air needed to run handpieces and pressurize the water and cooling system.

The regulator/pressure gauge should be set to read 70 p.s.i./5 BAR. The tank pressure gauge should read 110 p.s.i./7.5 BAR. See page 21

Operating the Silent Hurricane Oil Free Compressor

1. Connect the unit to the appropriate voltage.
2. Check that the air tank on/off valve is closed. See page 23.
3. Switch unit on at the mains (power outlet).
4. Turn unit on at switch situated on top of the pressure switch. See page 21.
6. Motor should now run and will stop running when 110 p.s.i./7.5 BAR. has been reached.
7. Connect the grey air line from dental unit to the compressor and turn air tank valve to the ON position. See page 23

Identifying Air Leaks

To ensure the Silent Hurricane Compressor Motor is not subjected to higher than normal operating temperatures, each iM3 Dental unit should be checked for air leaks at regular intervals, the easiest way to check for air leaks is to pump the compressor tank up to 110 p.s.i./7.5 BAR. and turn the motor off. Make sure the air line to the dental head is connected and the tank valve left in the open position with the pressure switch for the water bottles also turned on.

Once the tank has been pumped to 110 p.s.i./7.5 BAR., check the pressure in the tank 10 minutes later. If the pressure has dropped more than 10% during that time then the unit is leaking air which should be identified and remedied to ensure the compressor motor does not overheat due to excessive running caused by the air leak.

Model: Silent Hurricane Oil Free compressor

Voltage: 220-240 50Hz

900W

Maximum operating Pressure 110psi (770KPa)



Manufactured By: iM3 Pty Ltd, Sydney Australia.

iM3 Dental Systems

iM3 Silent Hurricane Oil Free Compressor

**Circuit breaker located on the side of Black electrical box.
Push to Reset**

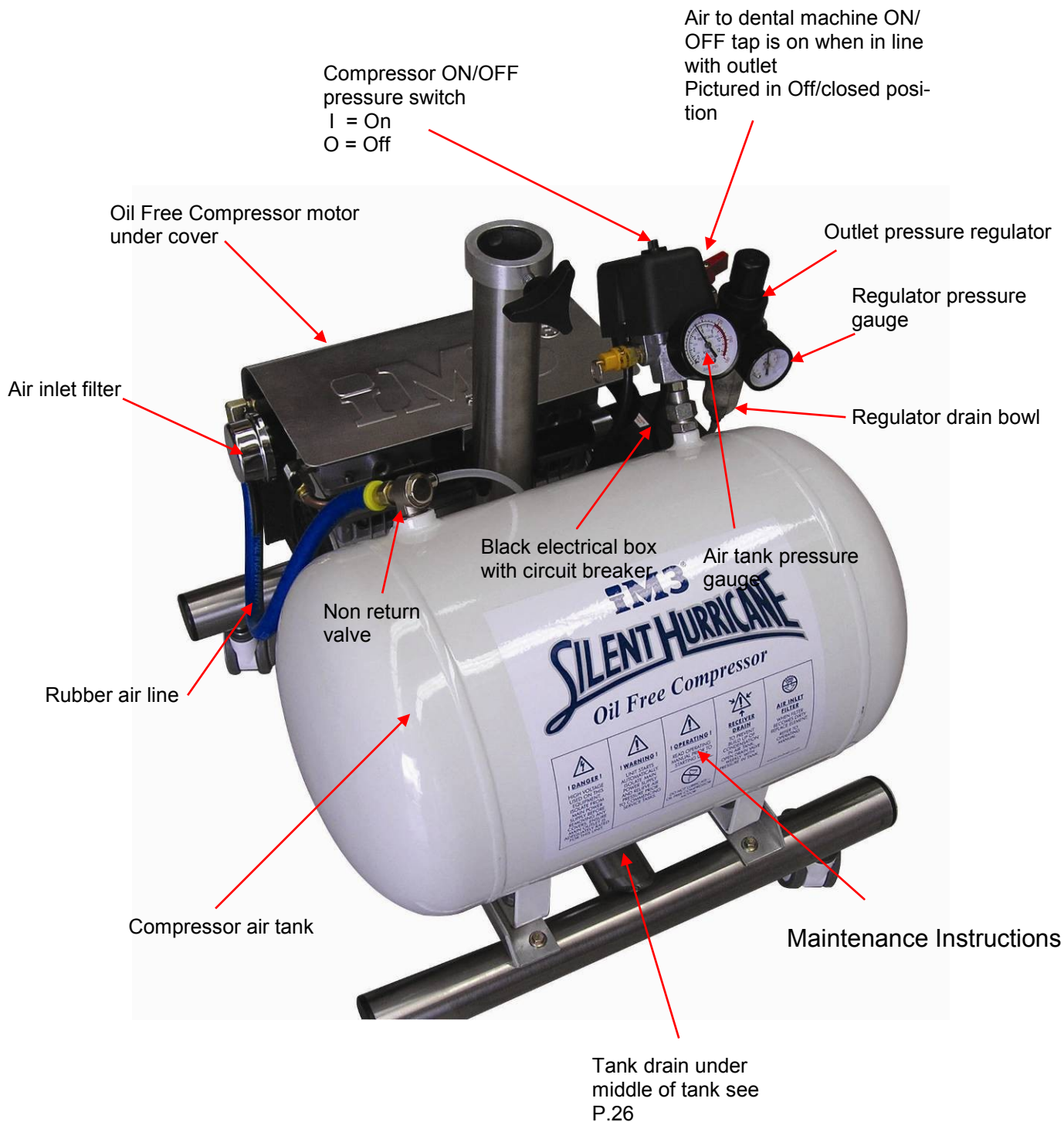

Silent Hurricane Compressor

Adjusting Regulator Air Pressure

With the Dental Unit pressurised and air lines turned ON, the black knob on top of the regulator is pulled up from the locked to the free position to adjust air pressure (see picture page 21). Depress the black knob after setting to lock pressure adjustment.

The regulator gauge registers working or air line pressure which may be increased by turning clockwise and lowered by turning anti clockwise.

The pressure air line gauge will register the working pressure, which should be 70 p.s.i./ 5BAR..



Warning

Unit starts automatically. Isolate power supply and relieve air pressure by opening tank ON/OFF valve prior to commencing non electrical service tasks.

This appliance is not intended for use by persons (including children) with reduced physical, sensory or mental capabilities, or lack of experience and knowledge, unless they have been given supervision or instruction concerning use of the appliance by a person responsible for their safety.

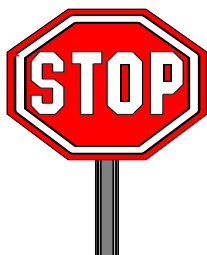

Danger

High voltage used on this equipment.
Isolate from mains before removing any covers, which should only be carried out by a qualified electrician .
Ensure power outlet is adequately rated for this unit.

Feature	Daily	Weekly	Monthly	Yearly
Silent Hurricane Compressor		To drain condensation, first reduce air pressure in tank to 10psi by opening air ON/OFF valve. Drain moisture from main compressor tank by opening the valve in the bottom of the white tank slowly to prevent the moisture from spraying.		Change air inlet filter on compressor motor.
Regulator - Auto Drain Filter	Automatic, when tank drained of moisture			Replace regulator filter.
Regulator - Air Pressure	Check that correct air pressure is being delivered.	See Adjusting Regulator Air Pressure on Page 22.		
Contact iM3 for your yearly compressor service kit.				

Compressor air regulator adjustment knob



Air ON / OFF (valve pictured in ON or open position)

Air inlet quick disconnect line, supplying air to dental machine

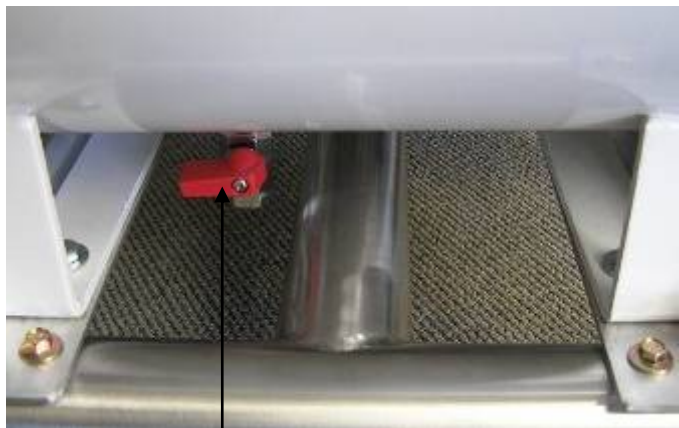

Compressor tank drain, located under white air tank—**open slowly**

Handpiece Trouble Shooting

High Speed Handpiece

PROBLEM	CAUSE	SOLUTION
No Water Flow in Handpiece	<ol style="list-style-type: none"> 1. Compressor not ON. 2. Water Flow Control not ON (P4-E). 3. Water/CLS Bottle Empty. 4. Check for a 'kink' in the water line. 5. Check if 3 way syringe has Water. 6. Use of tap water, blocking water valves. 7. Low regulator pressure. 	<ol style="list-style-type: none"> 1. Turn compressor ON and check that ON/ OFF tap is in the ON position. 2. Turn water control to ON. 3. Fill water/CLS Bottle(s). 4. Check lines and pressure. 5. If yes, lack of water must be in the valves or the handpiece. The 3 way syringe is the quickest way to check for water. 6. Valves will need replacing. 7. Check regulator is set at 70-80 PSI.
Mineral Accumulation	<ol style="list-style-type: none"> 1. Use of tap water - mineral or chemical action blockage will usually take 3-4 years to occur. 2. Verdigrase (Green Slime) build up in brass water valves due to chemical reaction with tap water. 	<ol style="list-style-type: none"> 1. Pass a fine wire through the water intake hole. Pass another fine wire through the hole in the handpiece head. Pass the wire as far as possible each way. 'Blow out' the loosened mineral deposits. 2. Replace valves.
Use of Chlorhexidine	<ol style="list-style-type: none"> 1. Most brands of Chlorhex will deposit out of solution and block valves, etc. CLS is designed to be used in its diluted strength without depositing. NOTE: Do not dilute CLS beyond its label recommendations or it could result in deposits. 2. Chlorine in tap water will cause a flocculation and block filters and valves 	<ol style="list-style-type: none"> 1. Contact your local iM3 Official Service Center. 2. Contact your local iM3 Official Service Center. Use only distilled water

Cartridge Toggle

Toggle switches become floppy

All iM3 dental units use a unique cartridge system for the toggle switches. The toggles are used to pressurize the water/CLS bottles and select the low or high speed handpiece. When the o-rings become worn you simply push the cartridge in and turn a 1/4 turn anti clockwise. The cartridge can then be removed from the valve casing. To install a new toggle, locate the desired position, push and rotate a 1/4 turn clockwise. New toggles can be ordered from iM3 and installed by the user. Toggles can be installed in the 12, 3, 6 and 9 o'clock positions. If the toggle is in the wrong position simply remove and reposition. View this procedure on the iM3 website http://www.compad.com.au/cms/im3vet/pages/iM_elite_film/222

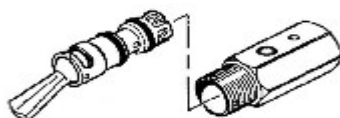

Handpiece Trouble Shooting

Low Speed Handpiece

PROBLEM	CAUSE	SOLUTION
Handpiece won't run	<ol style="list-style-type: none"> 1. No or low air pressure. 2. Air line improperly sealed. 3. Inferior oil; too much or excess more commonly too little oil or water in the turbine. 4. Broken drive head. <p>Note new handpieces require a "Run in time" this can be up to 20 hours of use</p>	<ol style="list-style-type: none"> 1. Check the air line to be sure the air is turned on and the line is unobstructed. 2. Reconnect air line to handpiece making sure the gasket is fully contracted. 3. See lubrication instructions on page 17. 4. Contact your local iM3 official Service Centre. <p>If the motor stops spinning place a fine screw driver down the nose and rotate shaft.</p>

Low Speed Handpiece - 4:1 Straight Nose Cone

PROBLEM	CAUSE	SOLUTION
Cant fit R&R proph angle	<ol style="list-style-type: none"> 1. Plastic drive shaft broken off internally in Chuck housing. 2. Improper lubrication. <p>Only fit plastic iM3 R&R prophy angles Code L7465.</p>	<ol style="list-style-type: none"> 1. Contact your local official iM3 Service Centre. 2. See lubrication instructions, on page 17.

iM3 Inc
 12119 NE 99th Street Suite 2060
 Vancouver WA 98682 USA
 Tel (360) 254 2981 Fax (360) 254 2940

iM3 Pty Ltd
 9/31-33 Chaplin Drive
 Lane Cove NSW 2066 Australia
 Tel (02) 9420 5766 Fax (02) 9420 5677

www.im3vet.com