



**PROFILE  
DESIGN**

---

**NEOSONIC ERGO 45AR AEROBARS**

REVISION 02-07-28-2023

## INTRODUCTION

**Thank you for purchasing this Profile Design Aerobar. These instructions apply to the Neosonic bracket, with Ergo, Race or Boom armrests and the Profile Design 45AR Extension.**

Please read these instructions thoroughly before attempting to install this item. Proper installation is required for compliance with Profile Design's warranty policy. If you are not familiar with installation of Aerobars or their accessories, please seek the assistance of your local Profile design dealer by logging on to [www.profile-design.com](http://www.profile-design.com) and using "dealer search" or by calling Profile Design's customer service number p.# 888.800.5999.

**Note to Dealers: If you install this product for the consumer, please provide him/her with this owner's manual after installation.**

### Tools and materials required:

- 5mm Hex Wrench
- Torque Wrench with a 5mm hex bit
- Assembly compound such as Finishline Fiber Grip™
- Threadlocker such as Loctite® Threadlocker Blue 242®
- Isopropyl alcohol
- Cutting guide
- Hacksaw (18T Blade for aluminium)
- Half round file
- Electrical/Insulation tape
- Clean, lint free cloth

## Your Aerobar kit should contain:

- Two (2) aerobar upper brackets (aluminium)
- Two (2) aerobar lower brackets (aluminium half round)
- Four (4) M6x18 bolts
- Two (2) M6x15 bolts preinstalled in the upper bracket
- One (1) aluminium extension
- Two (2) cable exit bar plugs
- Two (2) armrest cups
- Two (2) armpad cushions (foam)
- Two (2) hook and loop stickers
- Four (4) M6x12 countersunk bolts

## Optional accessories compatible with this Aerobar

- Profile Design Aerobar Bracket Riser Kit

**If anything is missing from the Aerobar kit please contact your dealer.**

Please note that threaded areas have been pre-treated by Profile Design during production with a special blue thread locking compound. This special compound is easy to detect on the threads of all bolts provided. If you cannot detect this thread locking compound or you are re-installing the bolt, re-apply a suitable blue thread locking compound as available from Loctite® or another company before assembly.

**WARNING: Periodically check the Aerobar for damage, particularly for scratches through the anodised coating (aluminium parts) or clearcoat (carbon parts) that could lead to degradation and weakening of the base material. Replace your Aerobar if you notice any damage from use or accident.**

# COMPONENT LIST

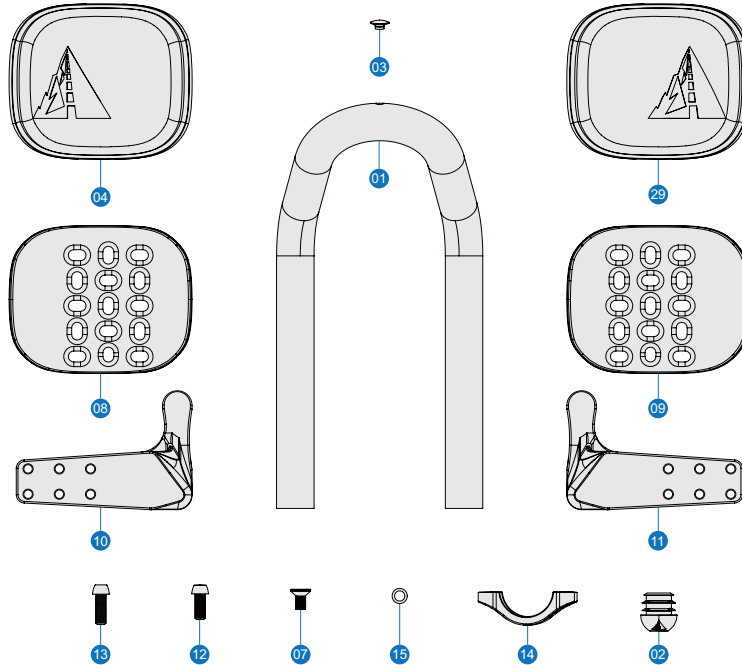

QTY. Req.	Part.#	Ref.#	Part Description
1	852274	1	Extension - 45ar 240mm Alloy Flat BK Ano W/BK Logo
2	716667	2	End Plug - 35C+ Black w/Cable Hole (Rear)
1	104276	3	Plug - Shift shift for Airstrike(5.5mm)
1	685221	4	Pad - Ergo/Race Ultra LT(A) 10mm
1	685222	29	Pad - Ergo/Race Ultra LT(B) 10mm
1	685216	5	Sticker - Ergo Hook Side A
1	685217	6	Sticker - Ergo Hook Side B
4	313593	7	Bolt - M6x12 FHB w/Nylok Stainless(SUS304)
1	200062	8	Armrest - ERGO W/Hook Sticker Side A(Left)
1	200063	9	Armrest - ERGO W/Hook Sticker Side B(Right)
1	189384	10	Bracket - Neosonic Top Bracket 31.8mm Flat Black(L/A)
1	189385	11	Bracket - Neosonic Top Bracket 31.8mm Flat Black(R/B)
2	312615	12	Bolt - M6x15 Blk CP Mushroom Cap
4	919211	13	Bolt - M6x18 Blk CP Mushroom Cap
2	189366	14	Bracket - Bottom Bracket 31.8mm Non-thread Flat Black
6	550006	15	Washer-M6x9x0.8 SS

# PART DRAWINGS

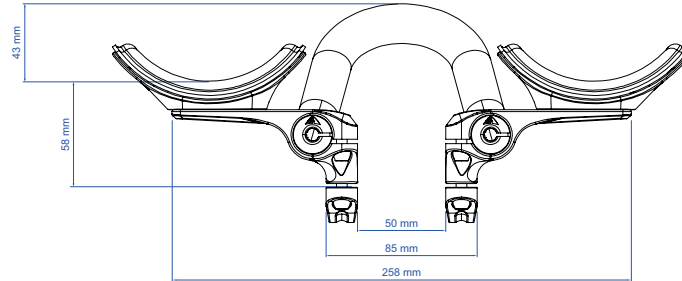
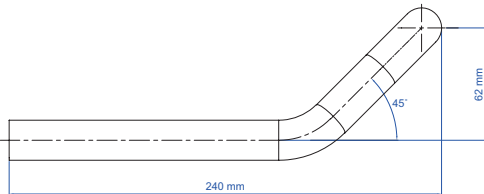
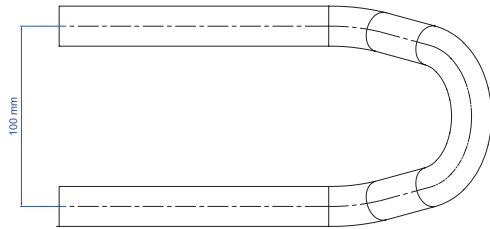
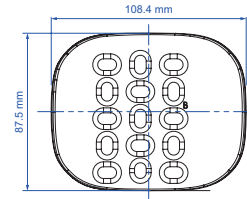
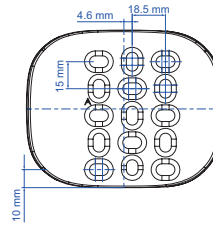
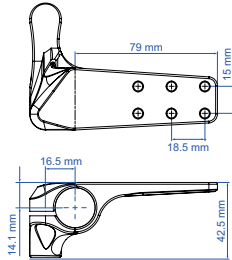

## PRODUCT SPECIFIC SETUP LIMITATIONS

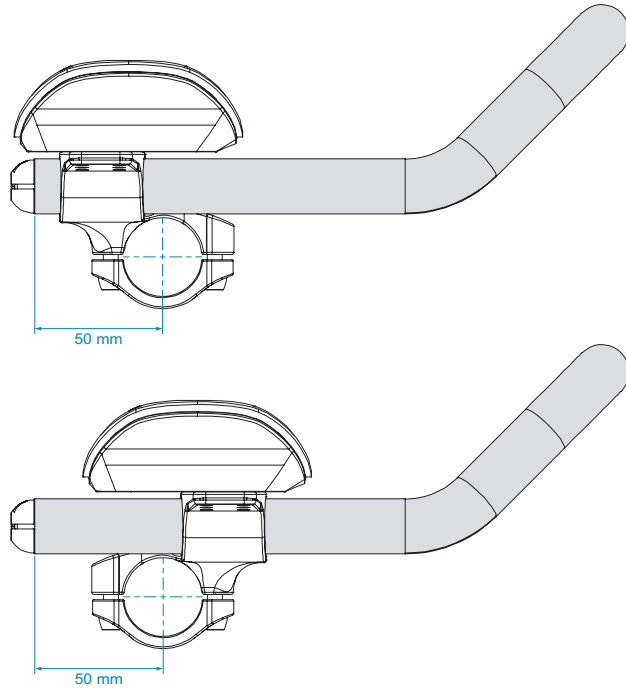

# TORQUE SETTINGS

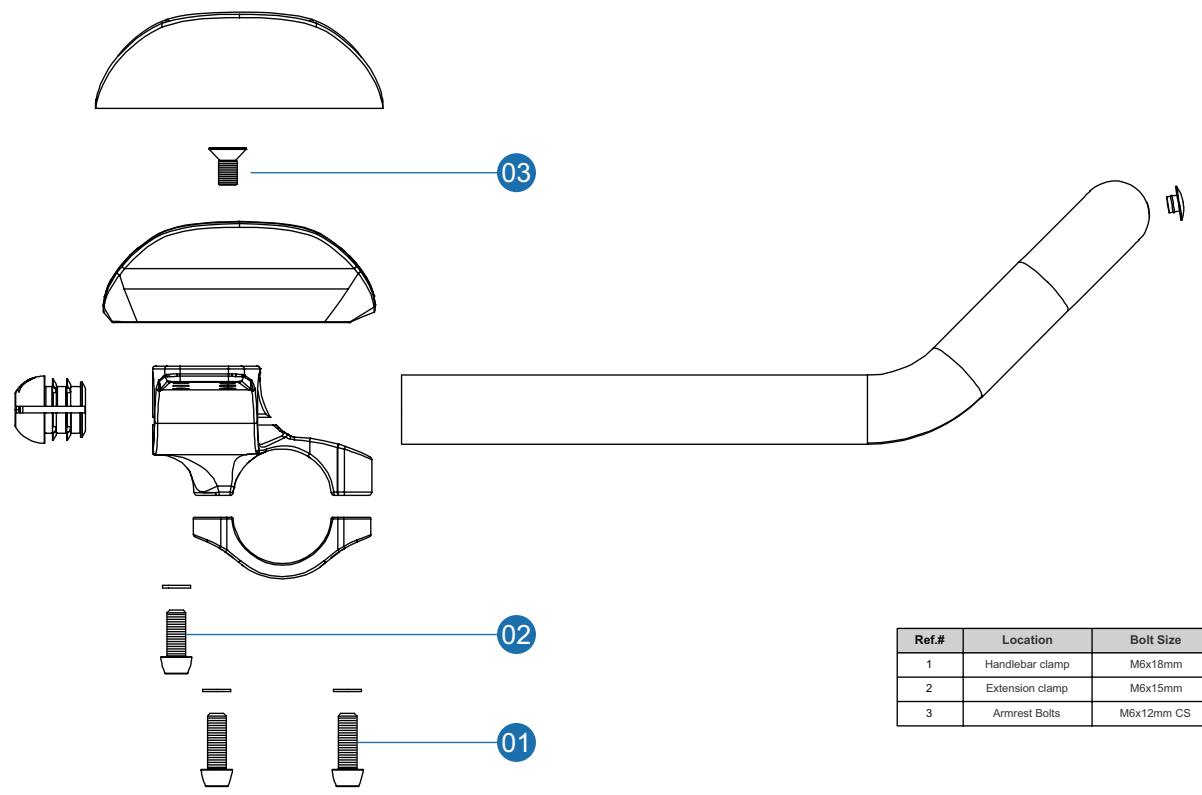

Ref.#	Location	Bolt Size	Torque
1	Handlebar clamp	M6x18mm	6Nm (53 inlbf)
2	Extension clamp	M6x15mm	6Nm (53 inlbf)
3	Armrest Bolts	M6x12mm CS	4.7Nm (42 inlbf)

# BOLT LENGTHS

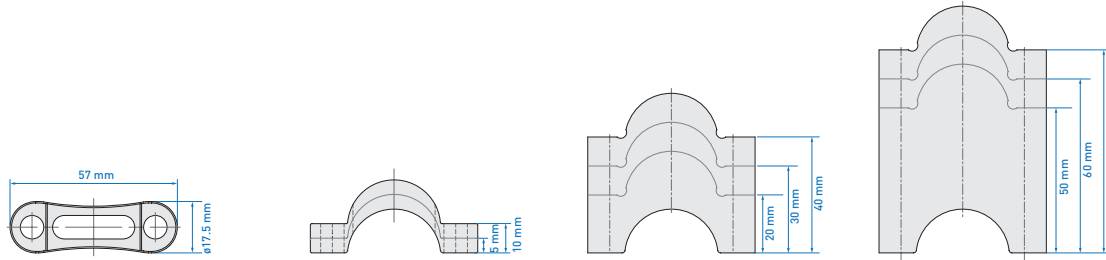

**⚠ Only use Profile Design supplied bolts.**

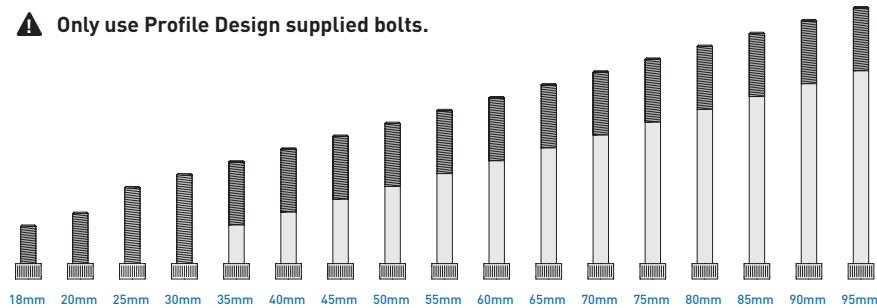

<b>Risers (mm)</b>	0	5	10	15	20	25	30	35	40	45	50	55	60	65	70	75	80
<b>Bolt (mm)</b>	18	20	25	30	35	40	45	50	55	60	65	70	75	80	85	90	95



## INSTALLATION INSTRUCTIONS

1. Apply a thin coating of assembly compound to the inside faces of the handlebar clamp on both the upper and lower parts of the bracket.
  - a. If you will be using an Aerobar Bracket Riser Kit apply assembly compound to all of the faces of the risers and follow the instructions with the Riser kit.
  - b. If you are using 31.8 to 26.0 reducing shims apply assembly compound to both sides of the shims.
2. Clasp the two halves of the handlebar clamp around the handlebar then use the 5mm Hex Wrench to install the M6 bolts through the lower bracket into the upper. Take care that the first thread engagement feels smooth to avoid cross threading the bolt.
3. Tighten the bolts until the aerobar bracket is firmly in place on the bar and repeat with the other side.

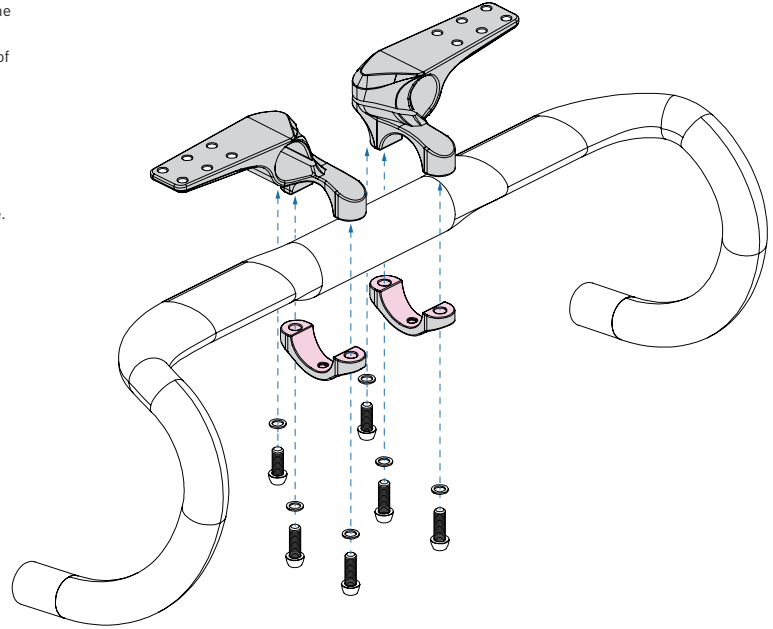

4. Apply assembly paste to the inside of the extension clamps.
5. Install the extension in the desired position and tighten the M3 extension fixing bolt using the 5mm Hex wrench so they are held snugly.
6. Check the placement of the brackets and extension then use the torque wrench with a 5mm fitting to tighten the handlebar clamp to 6Nm.
7. Then use the torque wrench with the 5mm fitting to tighten the extension clamps to 6Nm.

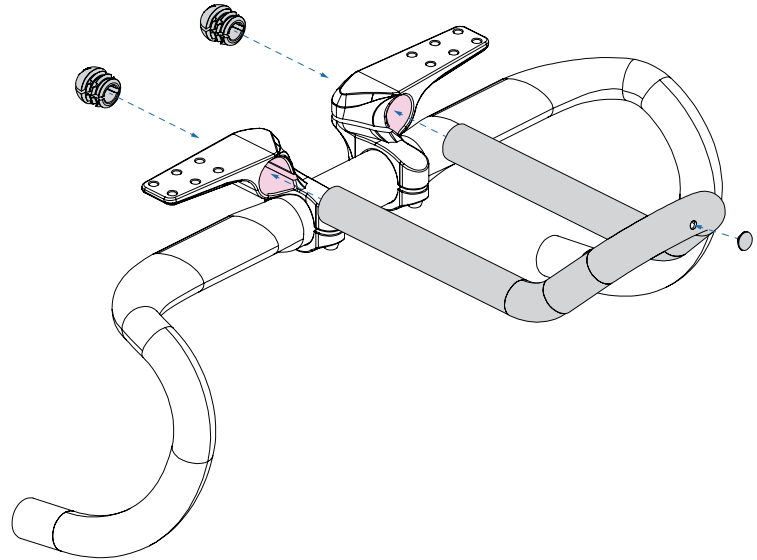

**WARNING:**  
Overtightening the handlebar clamp may lead to cracking and possible failure of the handlebar.

8. Fasten the armrests to the brackets using the M6x12mm countersunk bolts, note that the armrests have an offset design so care is required to ensure each side is positioned in the same way.
9. Apply a light coating of grease to the surface of the bolts as a protective layer against the effects of sweat.
10. Attach the cushion by placing carefully on hook and loop backing of the armrest and hold firmly for 30 seconds. Repeat for the other armrest. Note that the cushions on these models of armrest are symmetrical, so it doesn't matter which side each cushion is applied to.

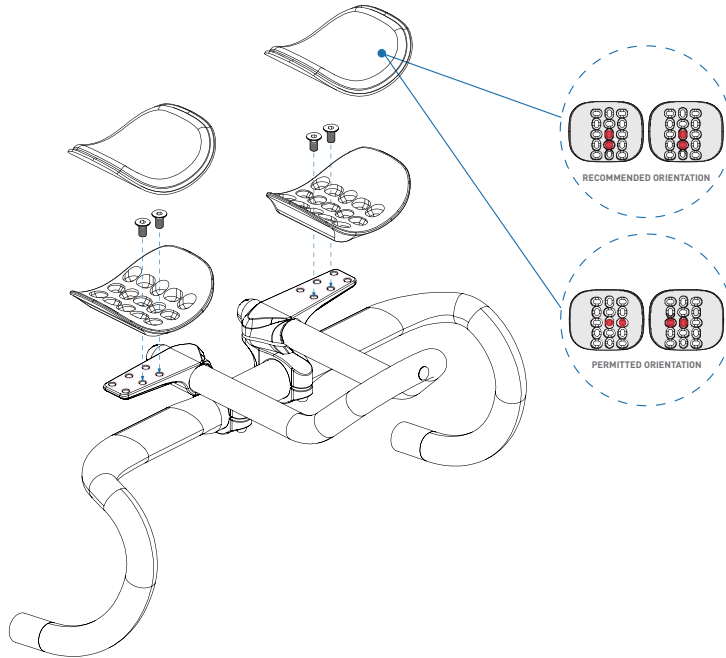

## HOW TO CUT THE EXTENSIONS

1. Carefully determine the required extension length by performing a bike fit or measuring the existing extensions.
2. Mark the point at which you wish to make a cut.
3. We recommend checking your measurements after first marking the cut line to ensure that you do not inadvertently cut the extensions too short.
4. Mount the cutting guide securely in a vice. Then place the extension in the guide and line up the marked cut line with the slot in the cutting guide.
  - a. For aluminium an 18 tooth blade is recommended. Along with eye protection.
5. Using the hacksaw, make firm strokes of the blade through the guide, allowing the blade to do the work. Do not apply excessive force to the hacksaw as you risk snapping the blade and the possibility of injury.
6. Repeat the process for the other side of the extension
7. Once you have cut both sides of the extension, use the half round file to remove any sharp edges from both the interior and exterior faces of the extension.

## HOW TO INSTALL NEW ARMRESTS

1. To fit the armrests first ensure the inner face of the armrest is free of lint and grease, if the armrest has previously had a hook and loop sticker applied the residue should first be removed either mechanically or with a citrus based solvent.
2. Before applying the hook and loop sticker, you may choose to wipe down the surface with isopropyl alcohol to ensure good adhesion. Remove the backing from the hook and loop sticker and apply it to the armrest, smoothing the sticker out to ensure there are no air bubbles trapped under it.
3. Allow the sticker 24 hours to cure before use.

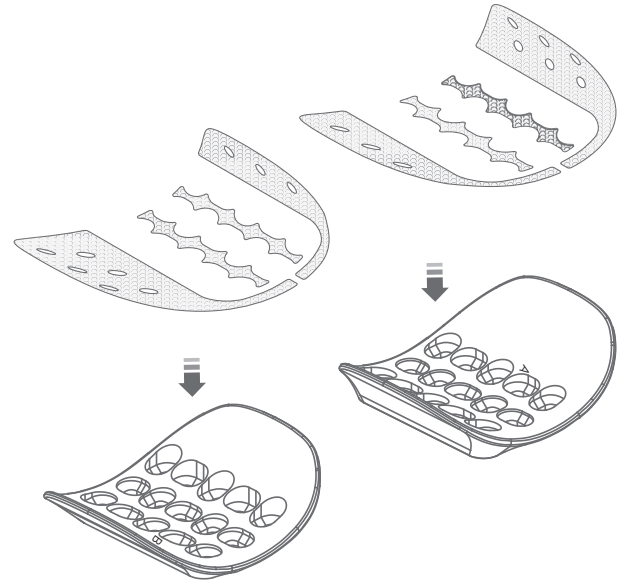
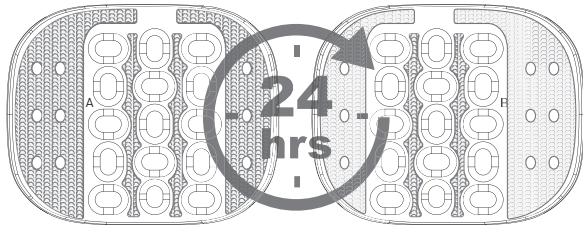

## ARMREST USAGE

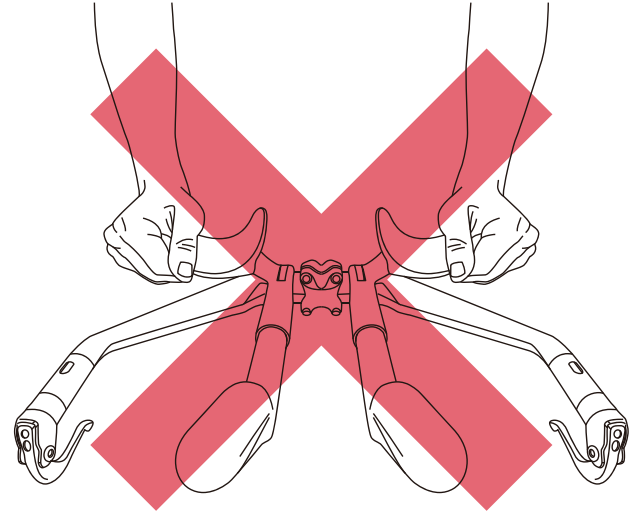
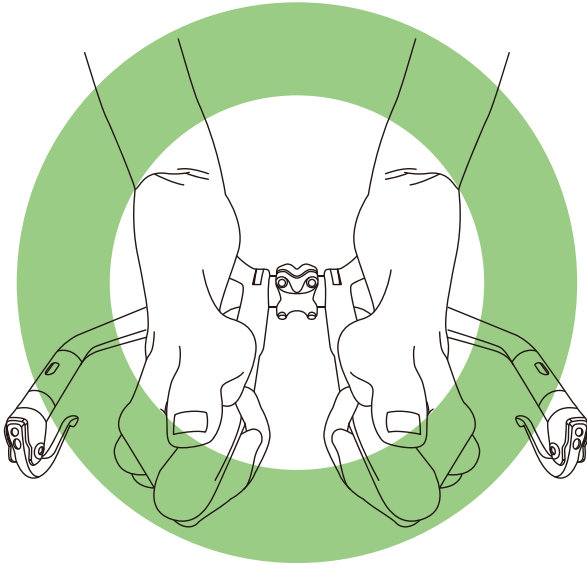

 **WARNING**

Do not put force on the side of the armrests!

## **WARRANTY POLICY**

- Profile Design Worldwide Two Year Limited Warranty.
- Profile Design, LLC (distributor) warrants to the original retail purchaser ("you") that the Profile Design product for which you received this warranty is free from defects in material and workmanship for (2) two years from the date of original retail purchase. For more details on this warranty, its exclusions and/or how to make a claim under the warranty please call +1 310.747.0085 extension 161 or visit [www.profile-design.com/pages/warranty](http://www.profile-design.com/pages/warranty)



2677 El Presidio Street  
Long Beach, CA 90810  
Ph: 310-884-7756

[www.profile-design.com](http://www.profile-design.com)

© Profile Design LLC