



AEROBAR EXTENSIONS

REVISION 01-05-25-2022

INTRODUCTION

Thank you for purchasing this set of Profile Design Aerobar Extensions. These instructions apply to the following extension series: SLC (35, 43, 45/25, 50) and A (26, 39, 52, 35, 43, 45/25, 50).

Please read these instructions thoroughly before attempting to install this item. Proper installation is required for compliance with Profile Design's warranty policy. If you are not familiar with installation of Aerobars or their accessories, please seek the assistance of your local Profile design dealer by logging on to www.profile-design.com and using "dealer search" or by calling Profile Design's customer service number p.# 888.800.5999.

Note to Dealers: If you install this product for the consumer, please provide him/her with this owner's manual after installation.

Tools and materials required:

- Assembly compound such as Finish Line Fiber Grip™
- Cutting guide
- Hacksaw with a 32T blade for Carbon Extensions
- Hacksaw with a 18T blade for Aluminum Extensions
- Half round file
- Electrical/Insulation tape
- Clean, lint free cloth

Your Extension kit should contain:

- Two (2) extensions (Carbon or Aluminum)
- Two (2) grip end bar plugs
- Two (2) cable exit bar plugs

Optional accessories compatible with these extensions:

- Aeria II Series Brackets
- Sonic Series Brackets
- Universal Computer Mount

If anything is missing from the extension kit please contact your dealer.

WARNING: Periodically check the extension for damage, particularly for scratches through the clearcoat (carbon parts) that could lead to degradation and weakening of the base material. Replace your extension if you notice any damage from use or accident.

COMPONENT LIST

26A 400mm

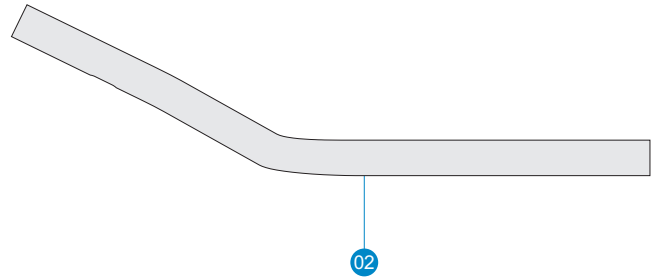
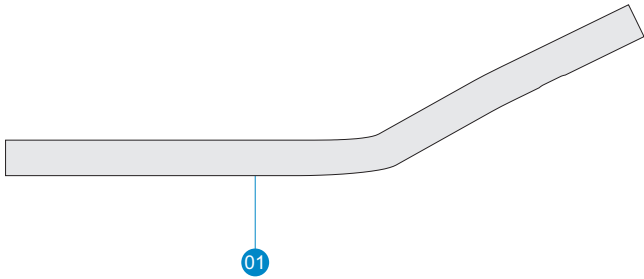

Ref.#	Part.#	QTY. Req.	Part Description
1	852295	1	26a Aerobar Extensions 400mm (L)
2	852296	1	26a Aerobar Extensions 400mm (R)

COMPONENT LIST

39A 400mm

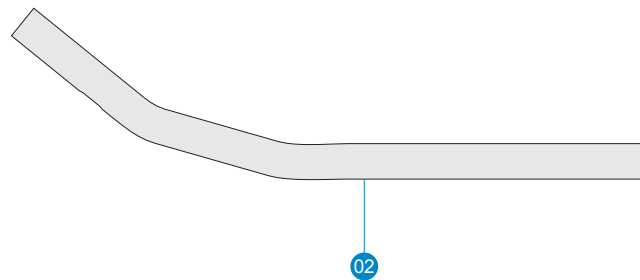
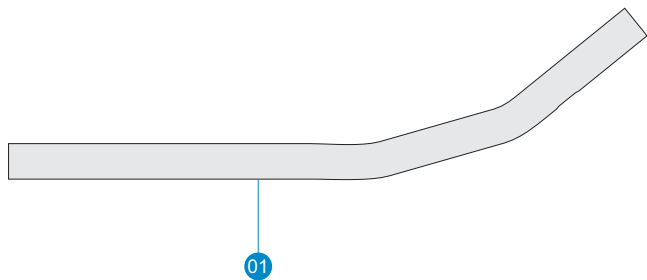

N° de réf.	N° de pièce	QTÉ. Req.	Description des pièces
1	852297	1	39a Extension 400mm (Gauche)
2	852298	1	39a Extension 400mm (Droite)

COMPONENT LIST

39AH 400mm

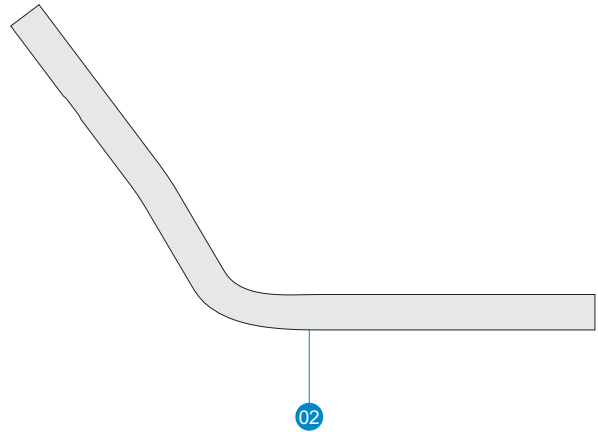
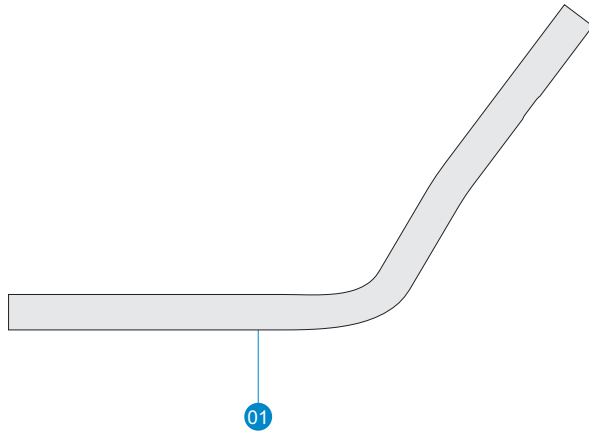

Ref.#	Part.#	QTY. Req.	Part Description
1	852293	1	39aH Aerobar Extensions 365mm (L)
2	852294	1	39aH Aerobar Extensions 365mm (R)

COMPONENT LIST

52A 400mm

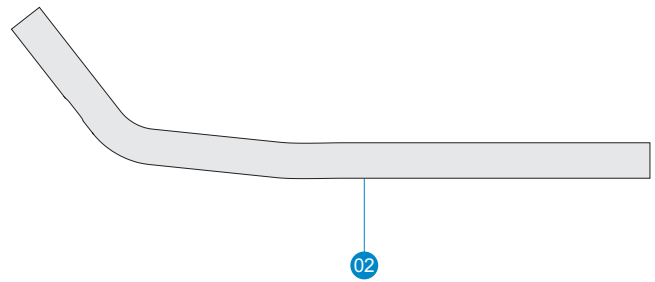
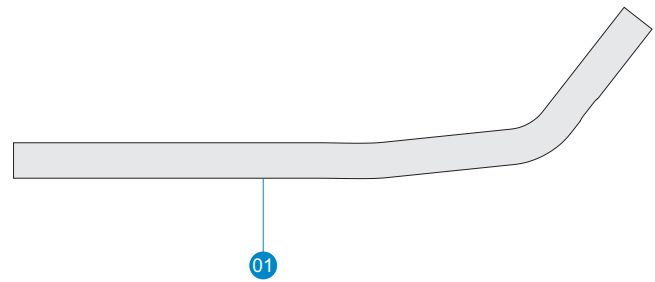

Ref.#	Part.#	QTY. Req.	Part Description
1	852299	1	52a Aerobar Extensions 400mm (L)
2	852300	1	52a Aerobar Extensions 400mm (R)

COMPONENT LIST

35A / 35SLC 340mm

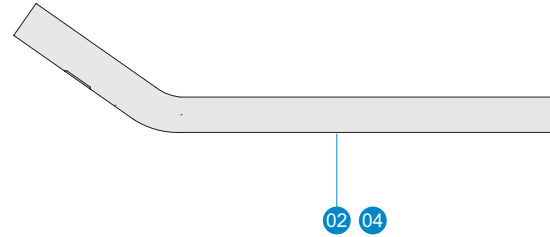
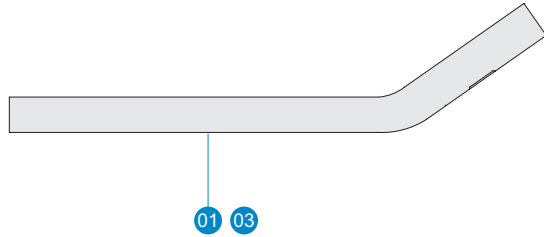

Ref.#	Part.#	QTY. Req.	Part Description
1	852245	1	35a Aerobar Extensions 340mm (L)
2	852246	1	35a Aerobar Extensions 340mm (R)
3	852277	1	35SLC Aerobar Extensions 340mm (L)
4	852278	1	35SLC Aerobar Extensions 340mm (R)

COMPONENT LIST

35A / 35SLC 400mm

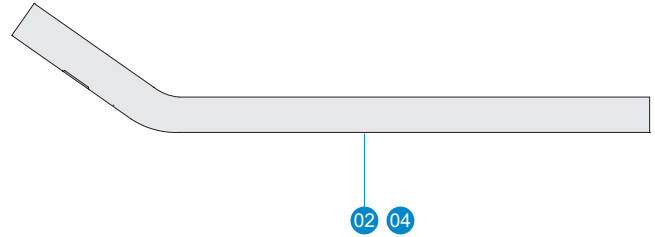
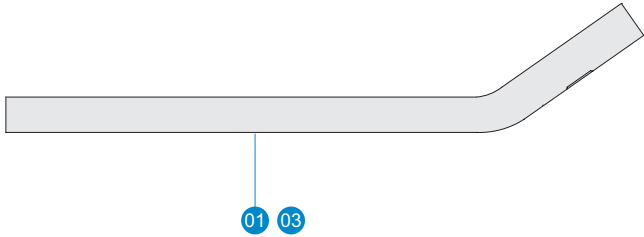

Ref.#	Part.#	QTY. Req.	Part Description
1	852266	1	35a Aerobar Extensions 400mm (L)
2	852267	1	35a Aerobar Extensions 400mm (R)
3	852279	1	35SLC Aerobar Extensions 400mm (L)
4	852280	1	35SLC Aerobar Extensions 400mm (R)

COMPONENT LIST

43A / 43SLC 400mm

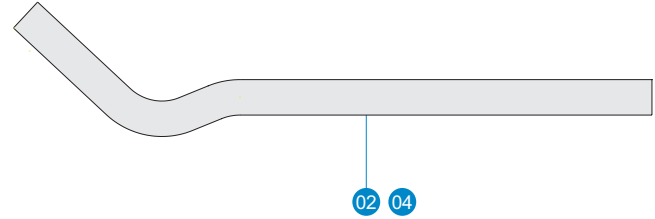
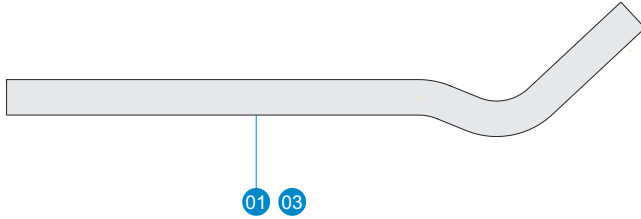

Ref.#	Part.#	QTY. Req.	Part Description
1	852275	1	43a Aerobar Extensions 400mm (L)
2	852276	1	43a Aerobar Extensions 400mm (R)
3	852281	1	43SLC Aerobar Extensions 400mm (L)
4	852282	1	43SLC Aerobar Extensions 400mm (R)

COMPONENT LIST

4525A / 4525SLC 400mm

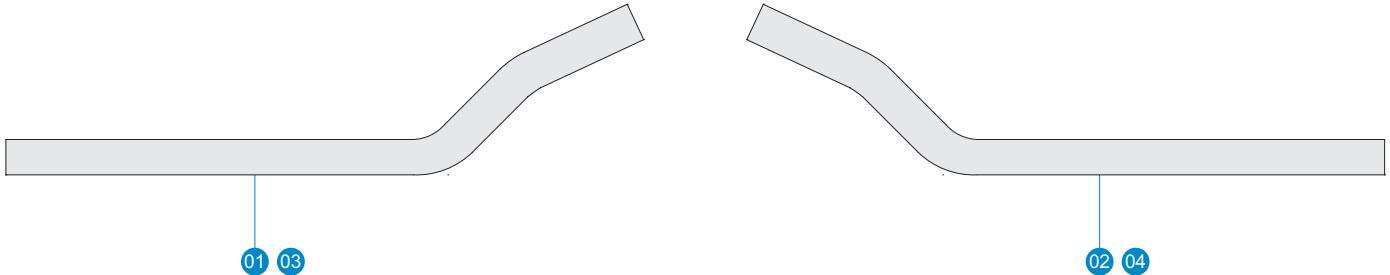

Ref.#	Part.#	QTY. Req.	Part Description
1	852247	1	4525a Aerobar Extensions 400mm (L)
2	852248	1	4525a Aerobar Extensions 400mm (R)
3	852283	1	4525SLC Aerobar Extensions 400mm (L)
4	852284	1	4525SLC Aerobar Extensions 400mm (R)

COMPONENT LIST

50A 340mm

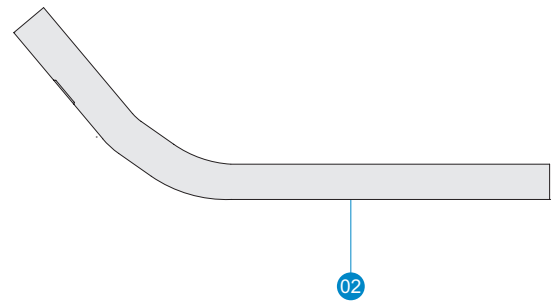
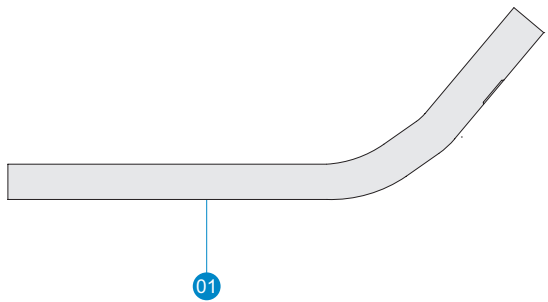

Ref.#	Part.#	QTY. Req.	Part Description
1	852270	1	50a Aerobar Extensions 340mm (L)
2	852271	1	50a Aerobar Extensions 340mm (R)

COMPONENT LIST

50A / 50SLC 400mm

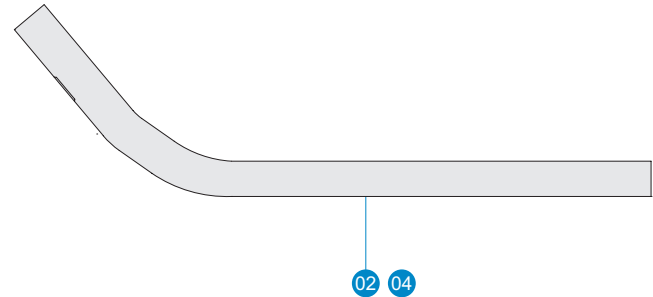
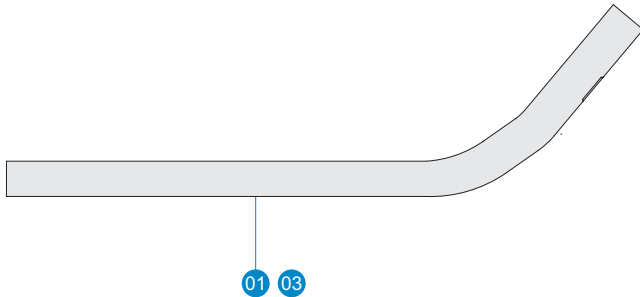

Ref.#	Part.#	QTY. Req.	Part Description
1	852249	1	50a Aerobar Extensions 400mm (L)
2	852250	1	50a Aerobar Extensions 400mm (R)
3	852285	1	50SLC Aerobar Extensions 400mm (L)
4	852286	1	50SLC Aerobar Extensions 400mm (R)

COMPONENT LIST

End Plug (Front)

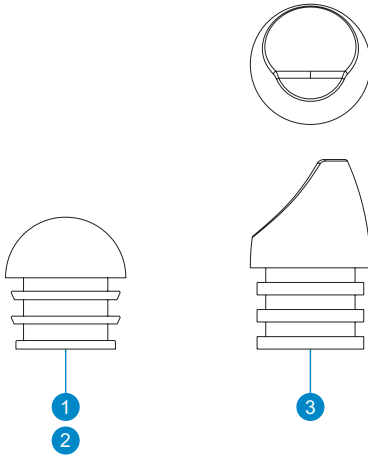

End Plug (Rear)

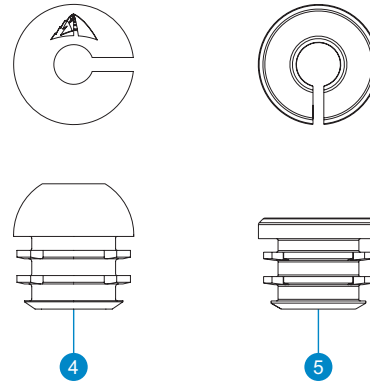

Ref.#	Part.#	QTY. Req.	Part Description
1	168428	2	End Plug - Round Aluminum (Front)
2	716669	2	End Plug - Round Carbon (Front)
3	716672	2	End Plug - Front End; 22.2x35mm
4	716667	2	End Plug - With Slot Hole / Logo (Rear)
5	716673	2	End Plug - Mechanical Ver (Rear)

PART DRAWINGS

26A

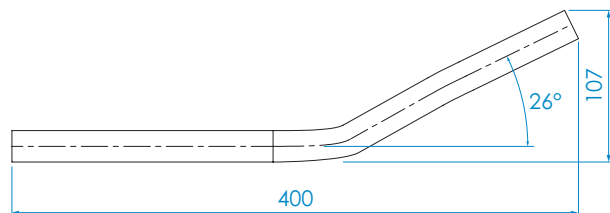

39A

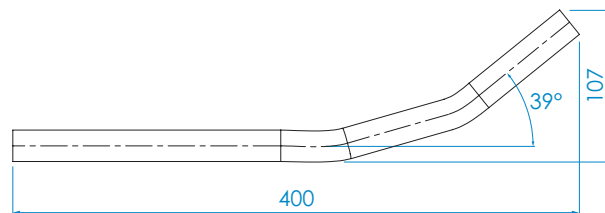

PART DRAWINGS

39AH

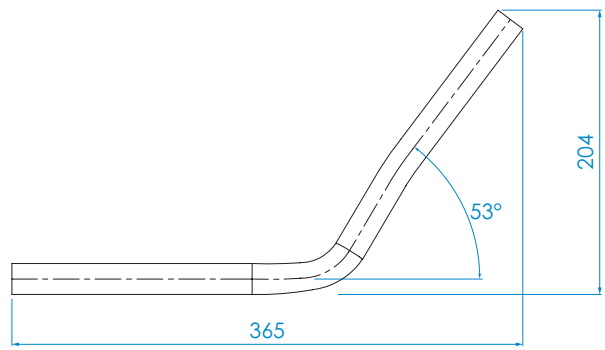

52A

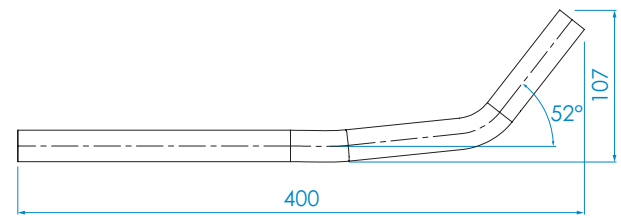

PART DRAWINGS

35A / 35SLC

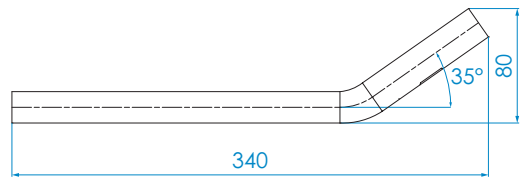
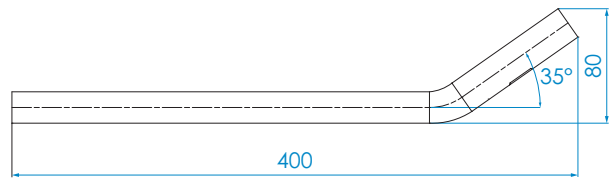

4525A / 4525SLC

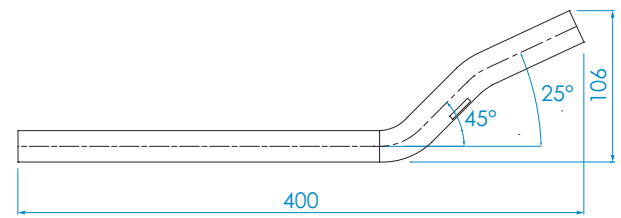

PART DRAWINGS

43A / 43SLC

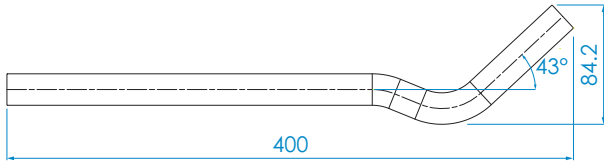

50A / 50SLC

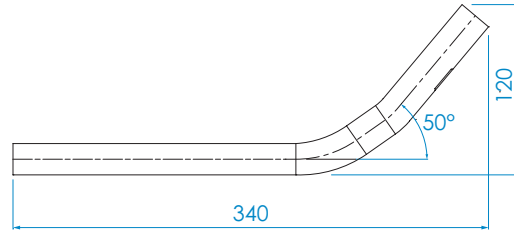
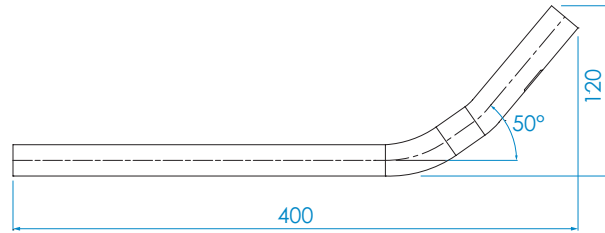

PRODUCT SPECIFIC SETUP LIMITATIONS

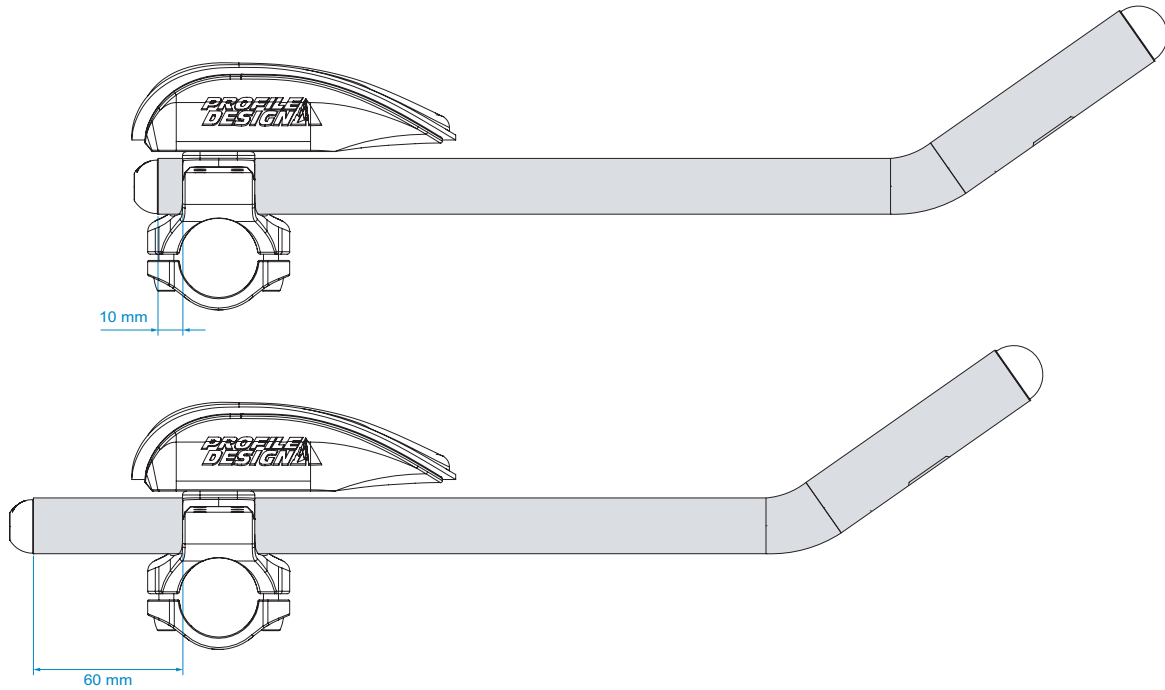

TORQUE SETTINGS

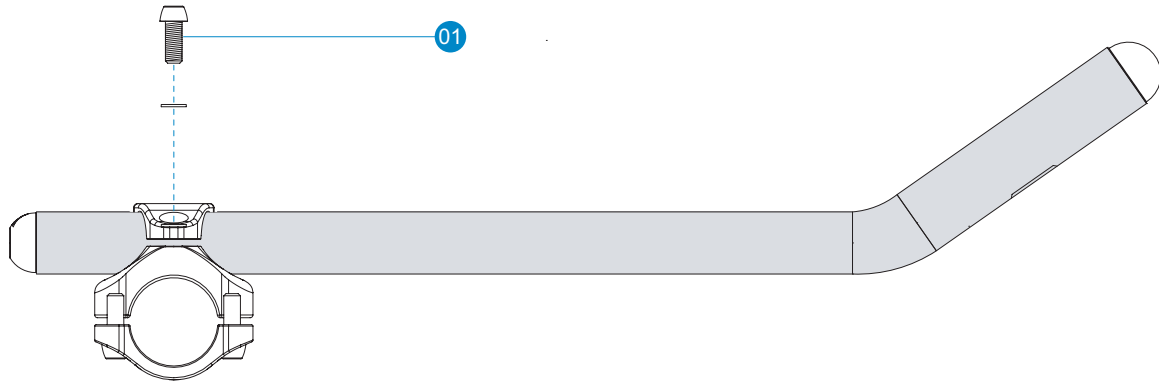



Ref.#	Location	Bolt Size	Torque
1	Extension clamp	M6x15mm	6Nm (53 inlb)

INSTALLATION INSTRUCTIONS

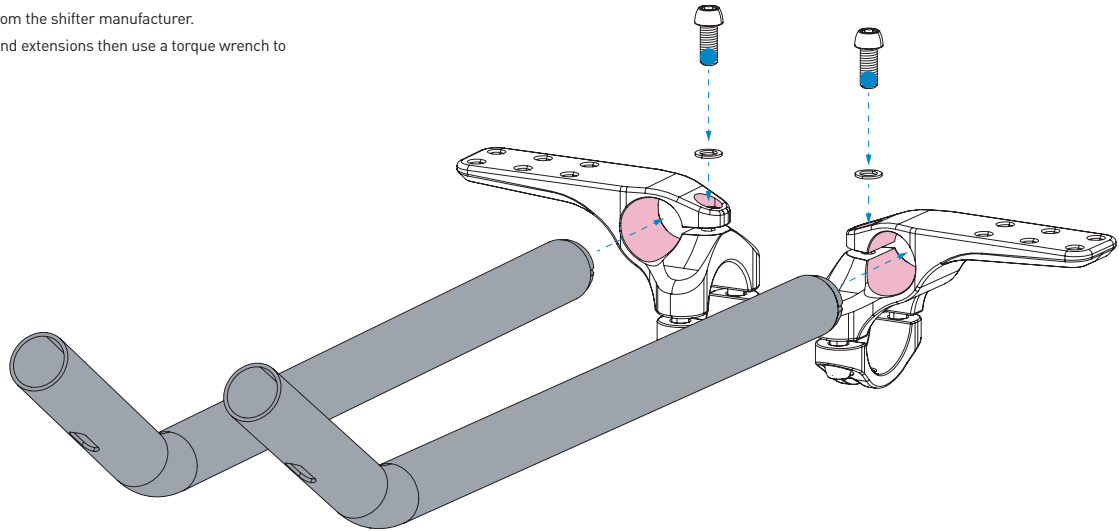
1. Install the extensions in the desired position and tighten the extension fixing bolt so they are held snugly.
2. Install the shifters (if using bar end models) as per the shifter manufacturer's instructions. We recommend a light coating of assembly compound on the inside of the extension prior to installing the shifter.
3. Install the cables as per instructions from the shifter manufacturer.
4. Check the placement of the brackets and extensions then use a torque wrench to tighten the extension clamp.



 Assembly compound
 Threadlocker

HOW TO CUT THE EXTENSIONS

1. Carefully determine the required extension length by performing a bike fit or measuring the existing extensions.
2. Mark the point at which you wish to make a cut.
3. We recommend checking your measurements after first marking the cut line to ensure that you do not inadvertently cut the extensions too short.
4. Mount the cutting guide securely in a vice. Then place the extension in the guide and line up the marked cut line with the slot in the cutting guide.
 - a. For carbon a 32T or carbon specific blade is recommended. Wrap the extension with insulation tape at the cut line to limit the risk of splintering the carbon at the blade exit point.
 - b. If cutting carbon, wear a breathing mask, gloves and eye protection then dispose of the dust residue carefully. Airborne dust particles are a respiratory hazard.
 - c. For Aluminum an 18T blade is recommended.
5. Using the hacksaw, make firm strokes of the blade through the guide, allowing the blade to do the work. Do not apply excessive force to the hacksaw as you risk snapping the blade and the possibility of injury.
6. Repeat the process for the second extension.
7. Once you have cut both extensions, use the half round file to remove any sharp edges from both the interior and exterior faces of the extension. A deburring tool may be used on Aluminum extensions (not Carbon).

 **WARNING**

- Profile Design Worldwide Two Year Limited Warranty.
- Profile Design, LLC (distributor) warrants to the original retail purchaser ("you") that the Profile Design product for which you received this warranty is free from defects in material and workmanship for (2) two years from the date of original retail purchase. For more details on this warranty, its exclusions and/or how to make a claim under the warranty please call +1 310.747.0085 extension 161 or visit www.profile-design.com/pages/warranty



2677 El Presidio Street
Long Beach, CA 90810
Ph: 310-884-7756

www.profile-design.com

© Profile Design LLC