



**PROFILE
DESIGN**

ERGO+ & RACE+ ARMREST KITS

REVISION 01-03-03-2023

INTRODUCTION

Thank you for purchasing this Profile Design Armrest kit. These instructions apply to the Ergo+ and Race+ kits.

Please read these instructions thoroughly before attempting to install this item. Proper installation is required for compliance with Profile Design's warranty policy. If you are not familiar with installation of Aerobars or their accessories, please seek the assistance of your local Profile design dealer by logging on to www.profile-design.com and using "dealer search" or by calling Profile Design's customer service number p.# 888.800.5999.

Note to Dealers: If you install this product for the consumer, please provide him/her with this owner's manual after installation.

Tools and materials required:

- 4mm Hex Wrench
- Torque Wrench with a 4mm hex bit
- Grease such as Finish Line Premium Grease

Your Armrest kit should contain:

- Two (2) armrest cups with hook & loop stickers
- Two (2) armpad cushions (foam)
- Four (4) M6x15 countersunk bolts

If anything is missing from the Armrest kit please contact your dealer.

Please note that threaded areas have been pre-treated by Profile Design during production with a special blue thread locking compound. This special compound is easy to detect on the threads of all bolts provided. If you cannot detect this thread locking compound or you are re-installing the bolt, re-apply a suitable blue thread locking compound as available from Loctite® or another company before assembly.

WARNING: Periodically check the Armrest for damage, particularly deep scratches in the cup. Replace the armrest if you notice any damage from use or accident.

COMPONENT LIST

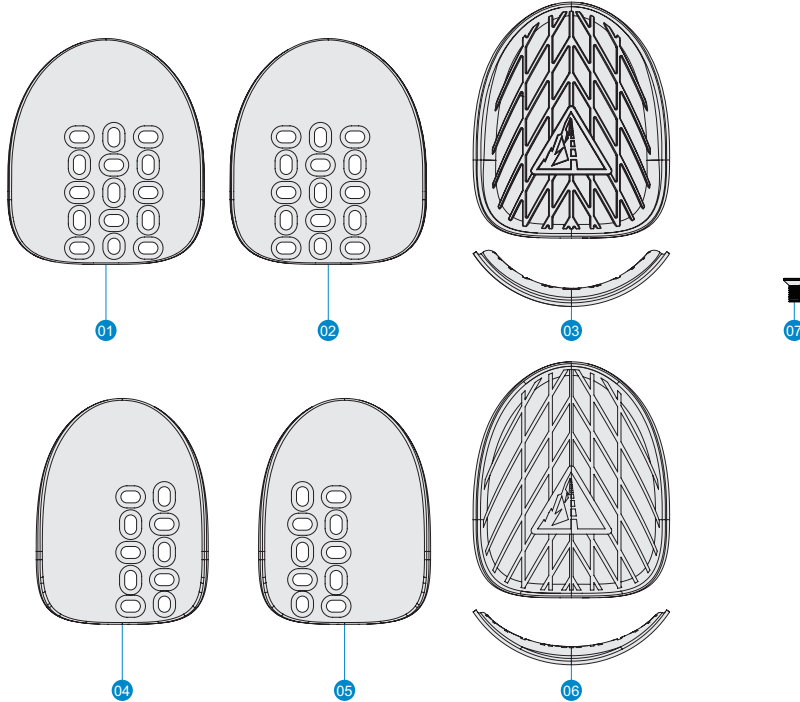

Ref.#	Part.#	QTY. Req.	Part Description
1	200072	1	Armrest - Ergo+ W/Hook Sticker Side A(Left)
2	200073	1	Armrest - Ergo+ W/Hook Sticker Side B(Right)
3	685224	2	Pad - Ergo+/Race+ Ultra 10mm
4	200074	1	Armrest - Race+ W/Hook Sticker Side A(Left)
5	200075	1	Armrest - Race+ W/Hook Sticker Side B(Right)
6	685223	2	Pad - Ergo+/Race+ Ultra 10-5mm
7	313593	4	Bolt - M6x12 FHB w/Nylok Stainless(SUS304)

PART DRAWINGS

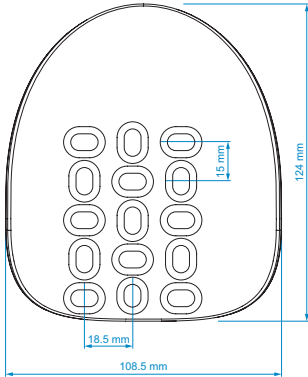

ERGO+
Pad available: 10mm, 10-5mm

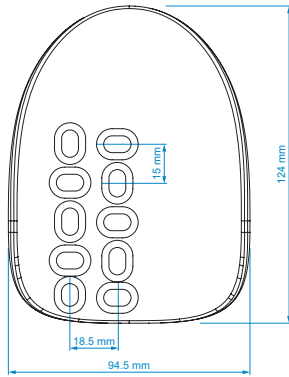

RACE+
Pad available: 10mm, 10-5mm

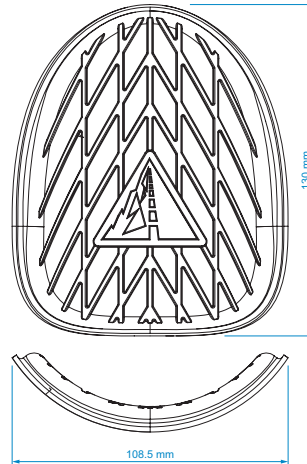

10mm Pad

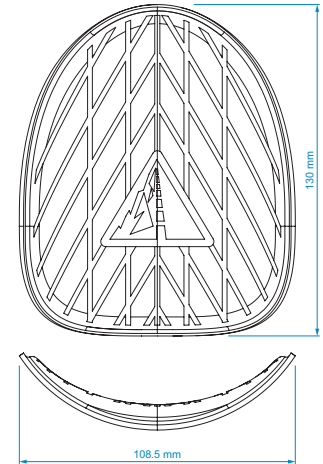

10-5mm Pad
Tapered - 10mm center, 5mm edge

PRODUCT SPECIFIC SETUP LIMITATIONS

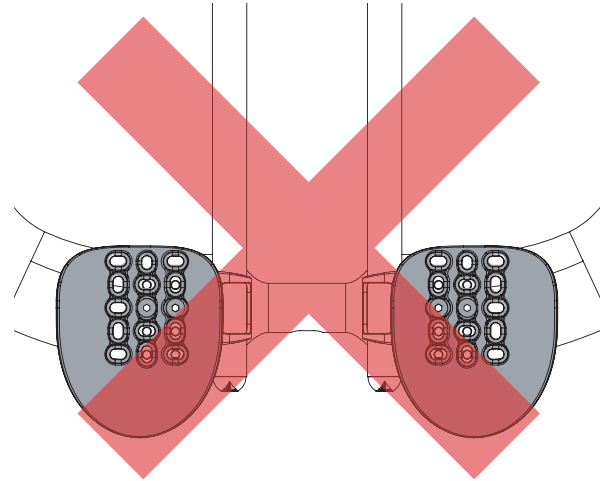
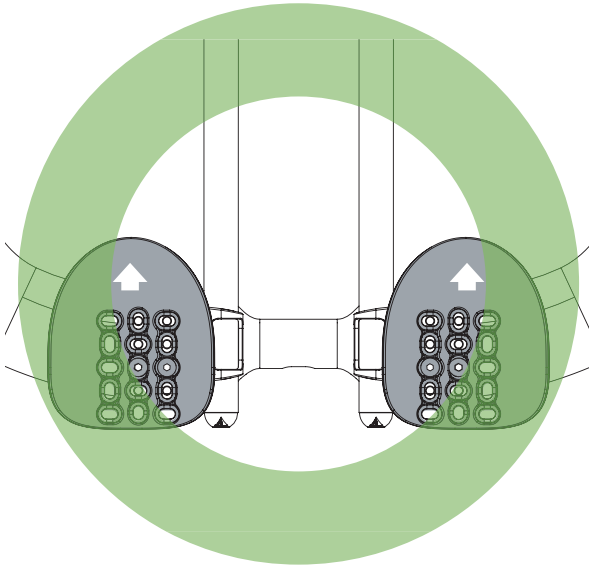

- The armrests are not designed to be used in the reverse position.

TORQUE SETTINGS

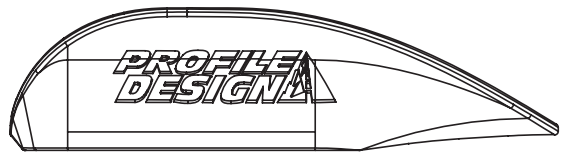
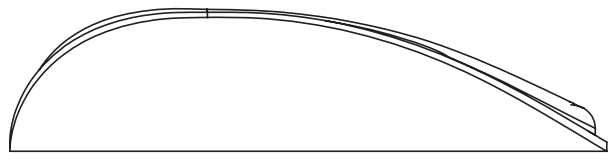

Ref.#	Location	Bolt Size	Torque
1	Armrest Bolts	M6x12mm CS	4.7Nm (42 inlbf)

INSTALLATION INSTRUCTIONS

1. Apply a light coating of grease to the surface of the armrest mount to protect against corrosion.
2. Fasten the armrests to the brackets using the M6x15mm countersunk bolts, note that the armrests have an offset design so care is required to ensure each side is positioned in the same way.
3. Torque the bolts to 4.7Nm using the torque wrench.
4. Apply a light coating of grease to the surface of the bolts as a protective layer against the effects of sweat.
5. Attach the cushion by placing carefully on hook and loop backing of the armrest and hold firmly for 30 seconds. Repeat for the other armrest. Note that the cushions on these models of armrest are symmetrical, so it doesn't matter which side each cushion is applied to.

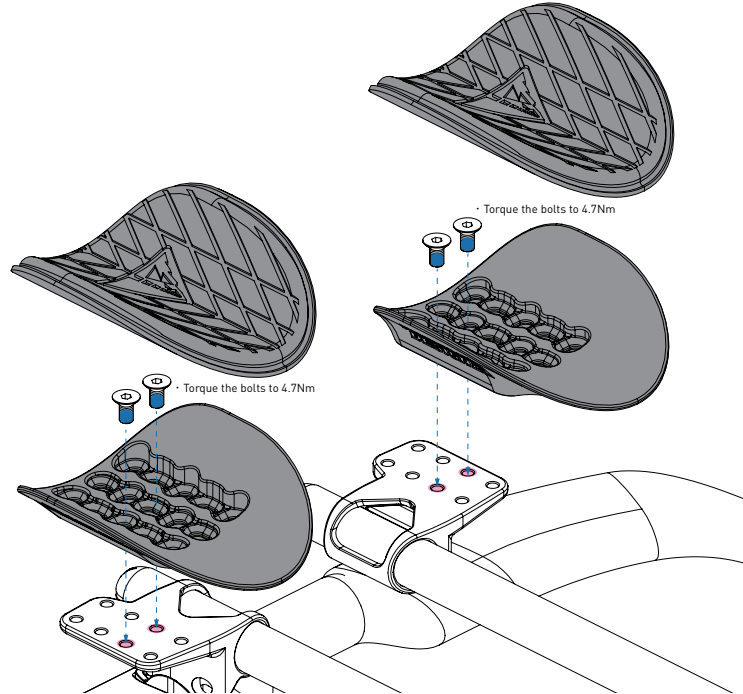

HOW TO INSTALL NEW ARMPADS

1. To fit the armrests first ensure the inner face of the armrest is free of lint and grease, if the armrest has previously had a hook and loop sticker applied the residue should first be removed either mechanically or with a citrus based solvent.
2. Before applying the hook and loop sticker, you may choose to wipe down the surface with isopropyl alcohol to ensure good adhesion. Remove the backing from the hook and loop sticker and apply it to the armrest, smoothing the sticker out to ensure there are no air bubbles trapped under it.
3. Allow the sticker 24 hours to cure before use.

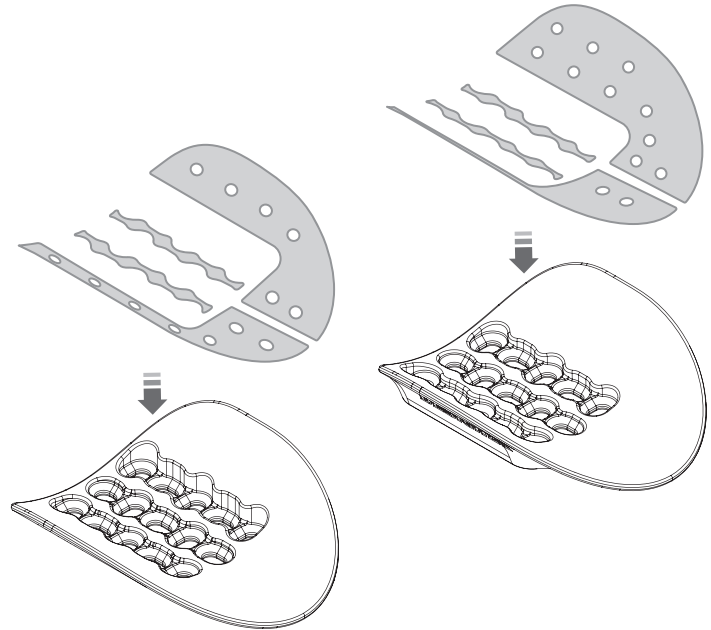
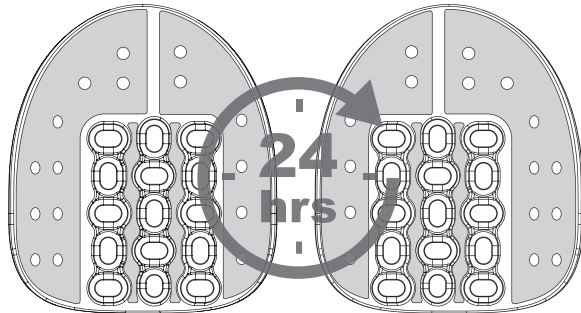

ARMREST USAGE

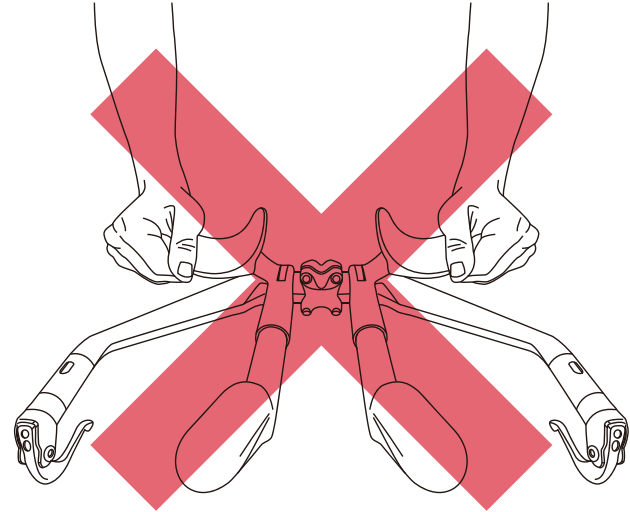
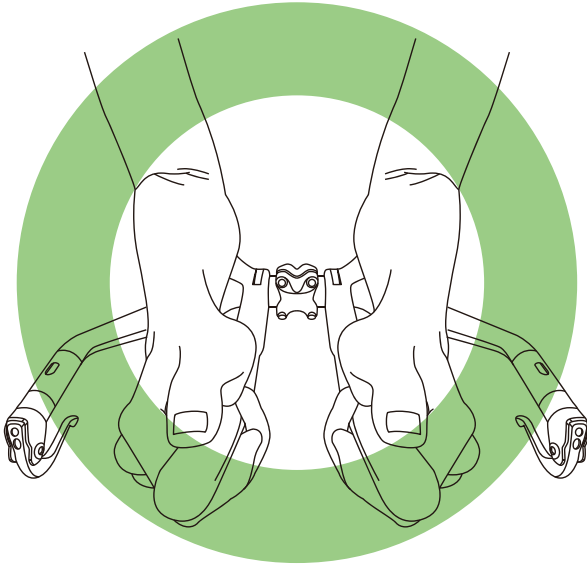

 **WARNING**

Do not put force on the side of the armrests!

 **WARNING**

- Profile Design Worldwide Two Year Limited Warranty.
- Profile Design, LLC (distributor) warrants to the original retail purchaser ("you") that the Profile Design product for which you received this warranty is free from defects in material and workmanship for (2) two years from the date of original retail purchase. For more details on this warranty, its exclusions and/or how to make a claim under the warranty please call +1 310.747.0085 extension 161 or visit www.profile-design.com/pages/warranty



2677 El Presidio Street
Long Beach, CA 90810
Ph: 310-884-7756

www.profile-design.com

© Profile Design LLC