

The logo for FLX, featuring the letters 'FLX' in a bold, italicized, sans-serif font. The 'F' is white with a red lightning bolt graphic extending from its top left corner. The 'L' and 'X' are white.

WWW.FLX.BIKE
FLX.BIKE/MANUAL



BLADE

USER MANUAL

TABLE OF CONTENTS



- 1 DEAR CUSTOMER**
- 2 QUICK START GUIDE**
- 4 COMPONENTS**
- 7 PROPER USE & SAFETY INFO**
- 9 ASSEMBLY INSTRUCTIONS**
- 16 TECHNICAL SPECS**
- 17 LCD SCREEN**
- 22 BATTERY CARE**
- 24 CLEANING & CARE**
- 25 USEFUL TIPS**
- 27 LEGAL REQUIREMENTS**
- 28 LEGAL DISCLAIMER**
- 29 LEGAL DETAILS**
- 30 TERMS & CONDITIONS**
- 33 CONTACT US**

DEAR CUSTOMER

Welcome to the FLX family! We're so happy you're here. We want to congratulate you on buying the BLADE - you've picked our top-of-the-line model!

*In this manual, we're going to break down the basics to make sure that your bike remains in top shape and performs to the highest standard. You're about to experience the ride of your life. In order to get you out and having fun as quickly and as safely as possible, please read the chapters: **QUICK-START GUIDE, USEFUL TIPS, SAFETY INFORMATION.***

We also highly recommend familiarizing yourself with local ebike laws and the components of your model prior to your first ride.

*Having trouble sleeping? Check out the chapter **LEGAL REQUIREMENTS** and **DISCLAIMER & DETAILS**. We promise it will put you right out.*

Ready to get started? Let's ride!
-Team FLX



QUICK START GUIDE

1. COMPLETELY CHARGE THE BATTERY BEFORE THE FIRST USE

• Insert the charging plug into the charging port on the battery. The light on the battery will turn red while the battery is charging. This indicator light will turn green when the battery is fully charged. A full charge will take 5-8 hours depending on battery type.

2. MOUNT THE FRONT WHEEL

• Make sure the front rotor is positioned properly between the front brake pads.

3. INSTALL THE HANDLE BARS

4. ATTACH THE PEDALS

• The left pedal has a reverse thread. To tighten, please turn counter-clockwise.

5. INSERT THE SEATPOST

• IMPORTANT: Insert below the minimum insertion point!

TOURING PACKAGE (OPTIONAL)

1. INSTALL THE RACK

2. ATTACH THE FENDERS

3. INSTALL THE SMARTPHONE MOUNT

flx.bike/manual

⚠ WARNING

FLX assumes that all persons involved in using, repairing, maintaining, cleaning, or disposing of any FLX product must have fully read and understood the content and meaning of these operating instructions. FLX takes no responsibility for any injury or damage resulting from improper use of any FLX product.

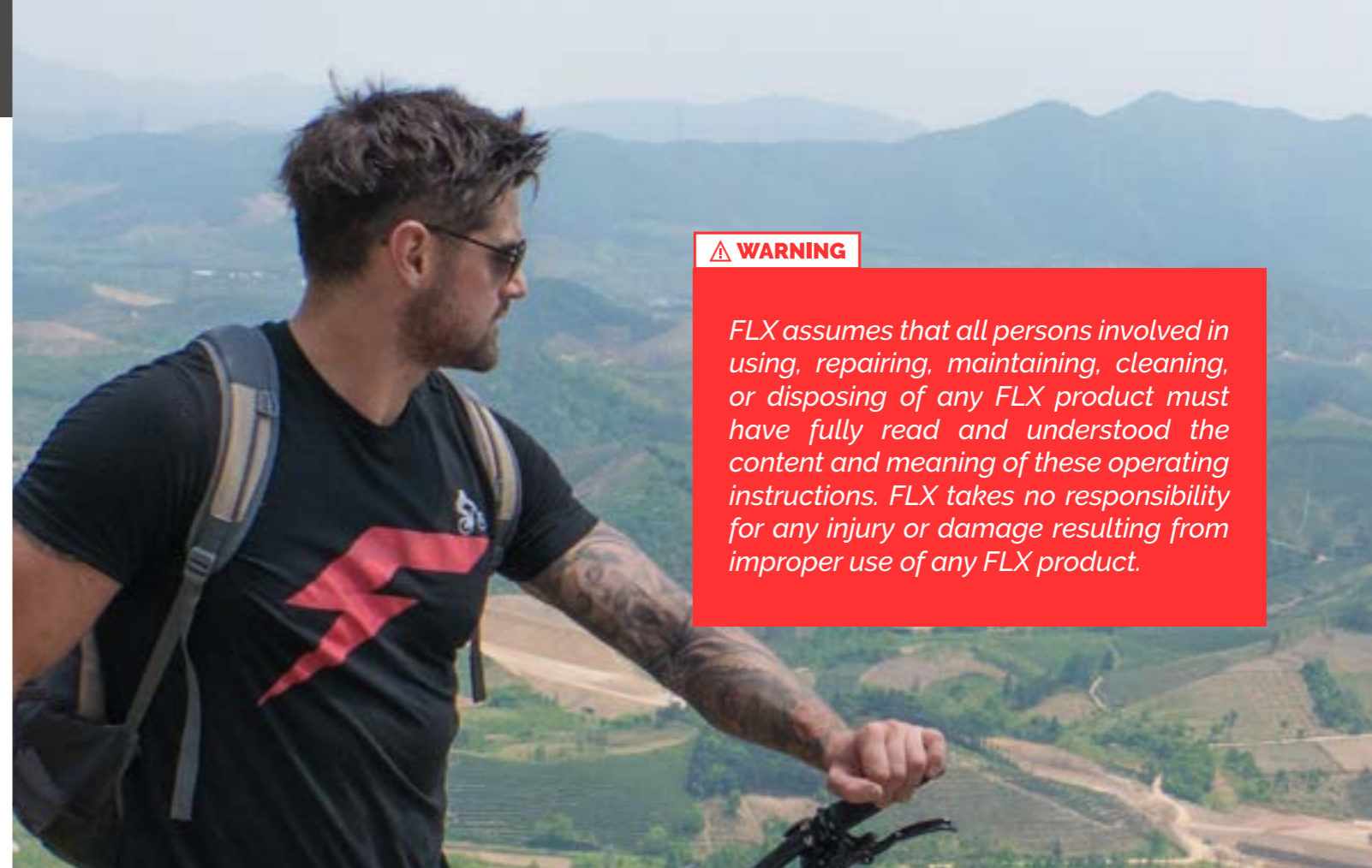

COMPONENTS PART 1



COMPONENTS PART 2

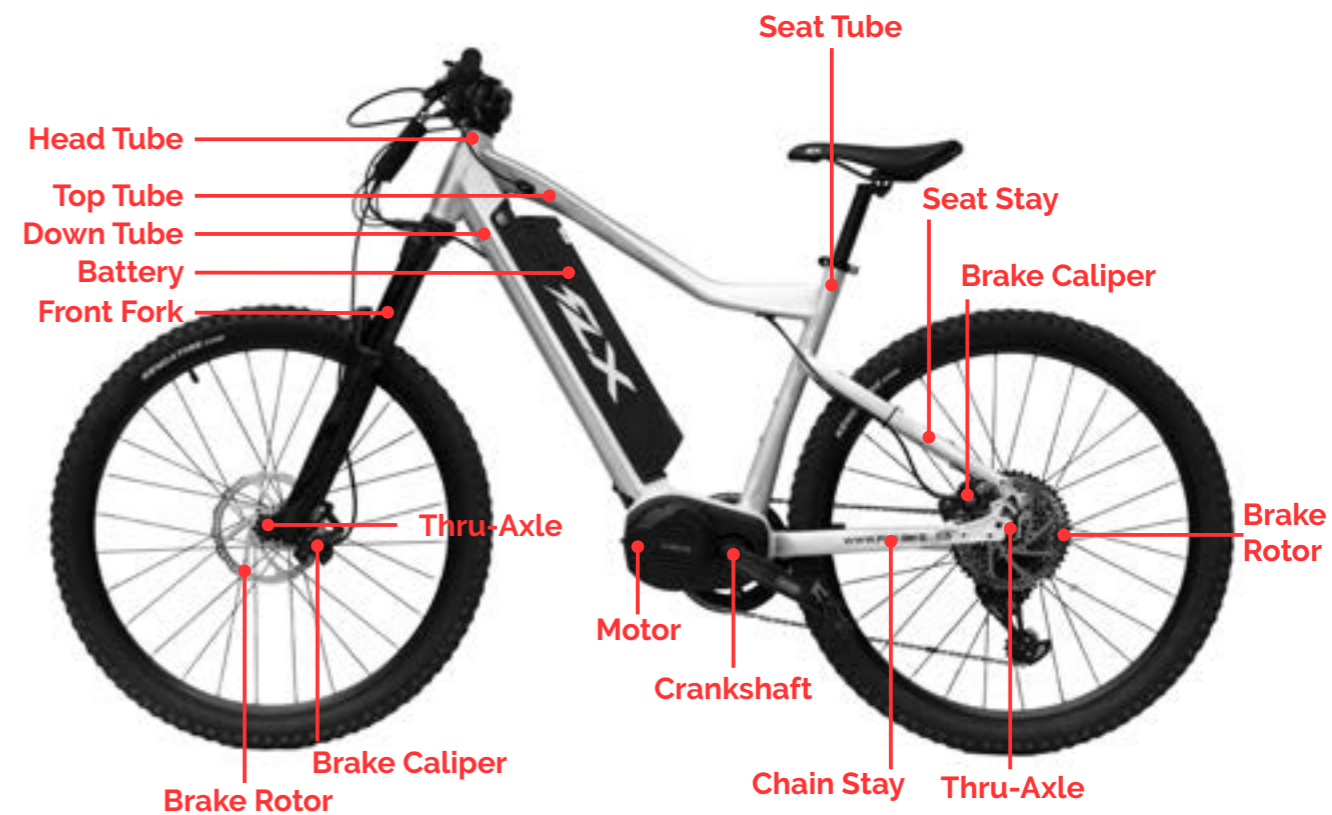

COMPONENTS PART 3



PROPER USE & SAFETY INFO

Before taking the bike for a ride, ensure that all components are attached properly. Neglecting to do so may cause issues in the future. Make sure you know about the local laws regarding electric bicycles in the areas you're riding in and abide by the regulations. Your safety, comfort, and happiness are of great importance to us and we can't stress enough how important the use of proper safety equipment is.

Although it may not be required by law, we highly recommend the use of pads and a helmet. Make sure to wear appropriately bright clothing during the day and use head and tail lights at night to increase visibility. Please use proper cycling hand signals and always be cautious when riding - whether you're in a bike lane or not.

While FLX bikes are built for heavy use, proper care and maintenance should be performed to maintain optimal performance. For cleaning information see: **CLEANING AND CARE**. Most adjustments to your FLX can be performed with basic tools. Larger issues should be handled by a qualified bike mechanic.



PROPER USE & SAFETY INFO

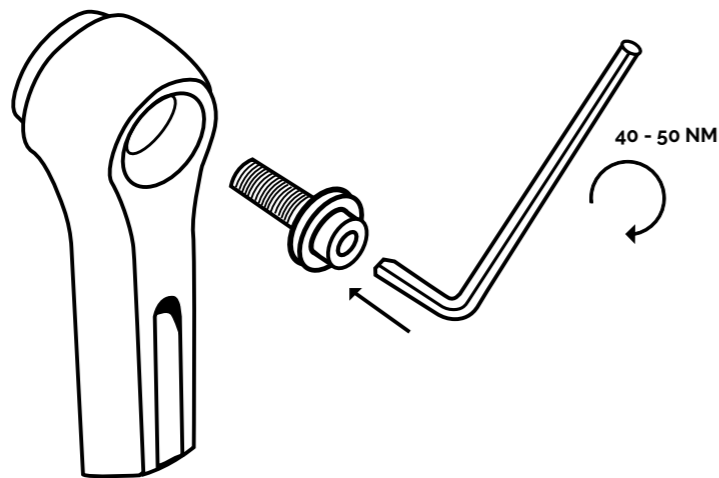

⚠ WARNING

Important Note: Please make sure to tighten the crank bolts (bolts which attach the pedal cranks to the motor shaft) after riding the first 50 miles, and every 100 miles thereafter. They should be tightened to 40-50NM, failure to maintain this tightening torque may result in the crank arm falling off during a ride, which could cause a serious accident.

flx.bike/faq

ASSEMBLY INSTRUCTIONS

STEPS

1. Wheel assembly
2. Handlebars assembly
3. Pedals assembly
4. Seatpost instructions
5. Before your first ride

INCLUDED TOOLS FOR ASSEMBLY:

1. M2.5 Hex Key (Display Bracket)
2. M4 Hex Key (Stem)
3. T25 Hex Key (Rotor)
4. 15mm Flat Wrench (Pedals)

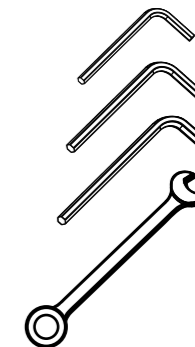

⚠ WARNING

Important notice: Please follow the instructions for assembly in the following pages carefully and properly. If you don't feel 100% confident assembling the bike, please take it to a bike shop for assistance.

STEP 1 WHEELS ASSEMBLY

Insert the wheels in the front fork (page 5) and make sure they are aligned with the brake rotor. Insert the Thru Axles through the routing and tighten.

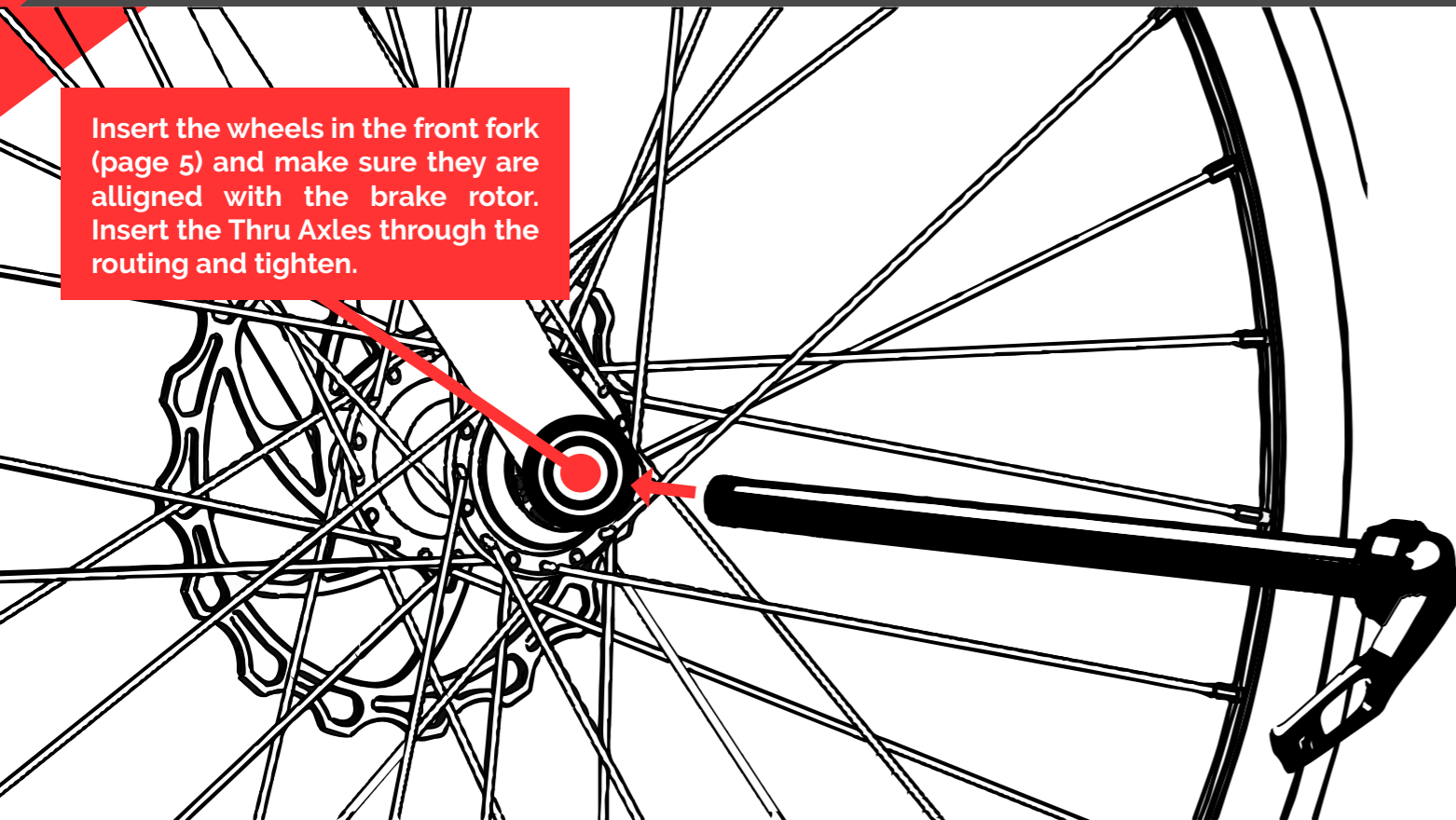

STEP 2 HANDLEBARS ASSEMBLY

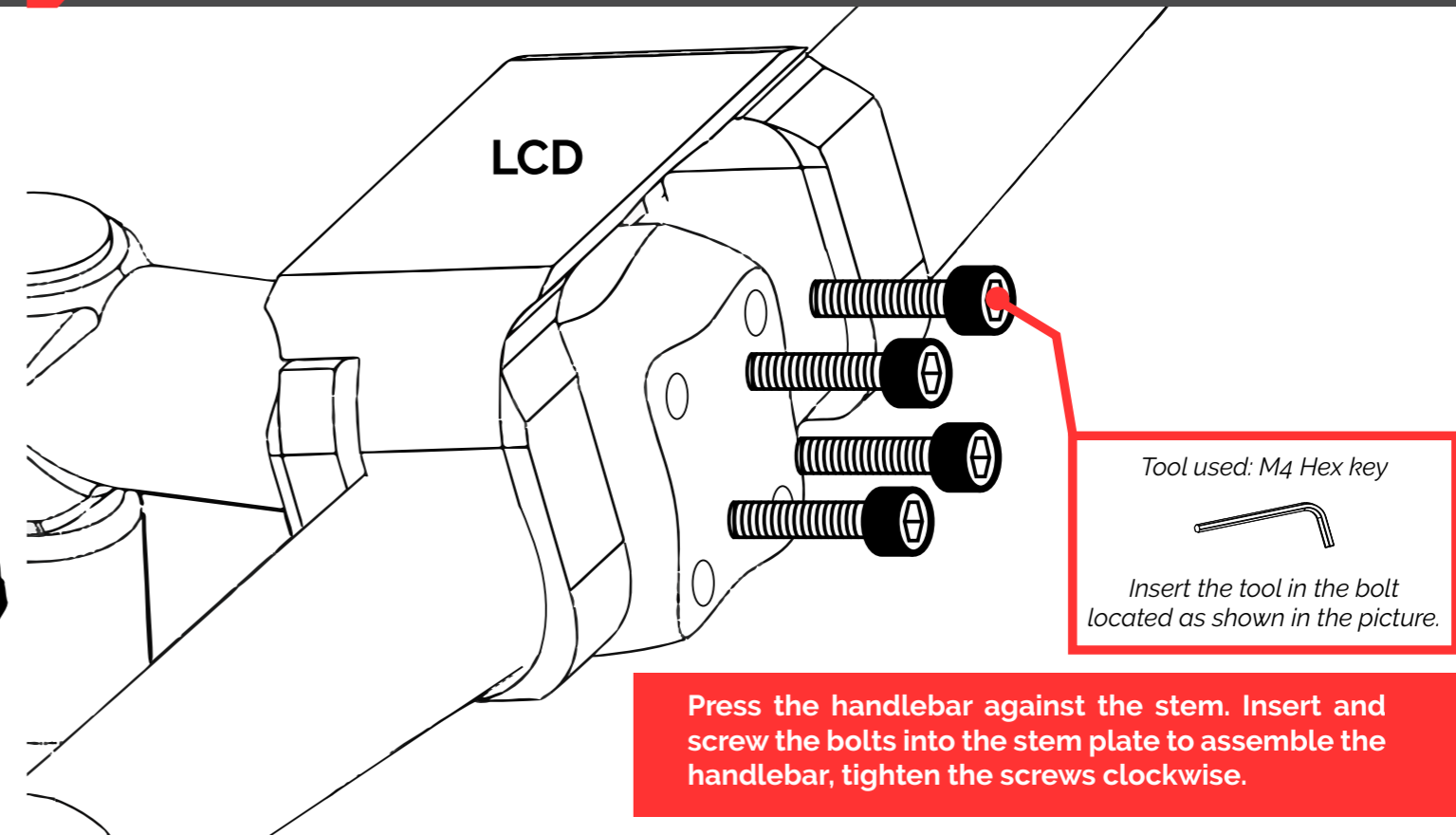

Tool used: M4 Hex key



Insert the tool in the bolt located as shown in the picture.

Press the handlebar against the stem. Insert and screw the bolts into the stem plate to assemble the handlebar, tighten the screws clockwise.

STEP 3 LEFT PEDAL ASSEMBLY

To attach the left pedal, please turn counter-clockwise.

Tool used:

Tool used: 15mm Flat Wrench



Insert the pedals carefully into the cranks and turn by hand in the direction shown.

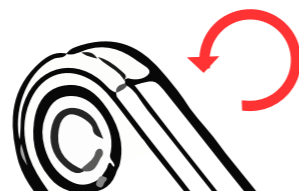
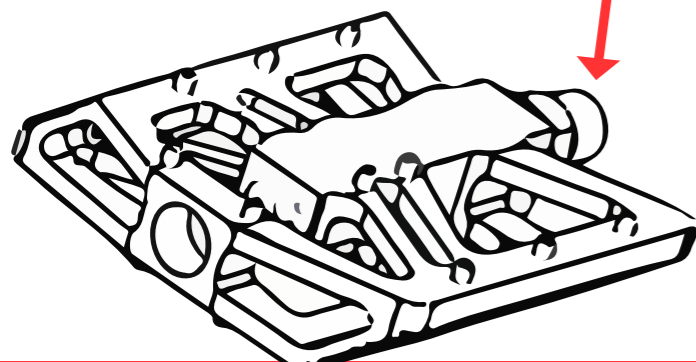

STEP 3 RIGHT PEDAL ASSEMBLY

To attach the right pedal please turn clockwise.

Tool used:

Tool used: 15mm Flat Wrench



Insert the pedals carefully into the cranks and turn by hand in the direction shown.

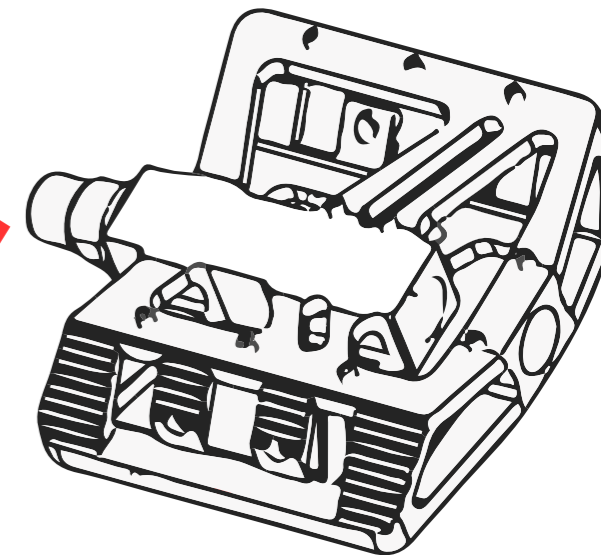
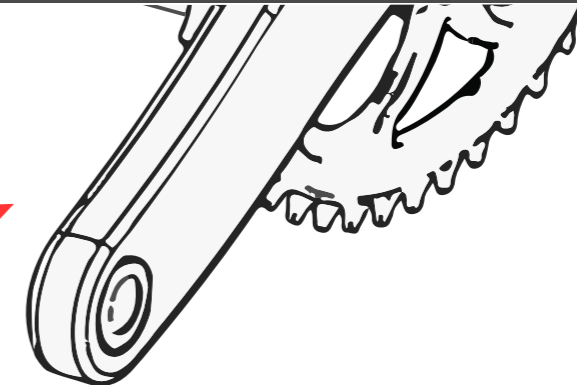

STEP 4 SEATPOST INSTRUCTIONS

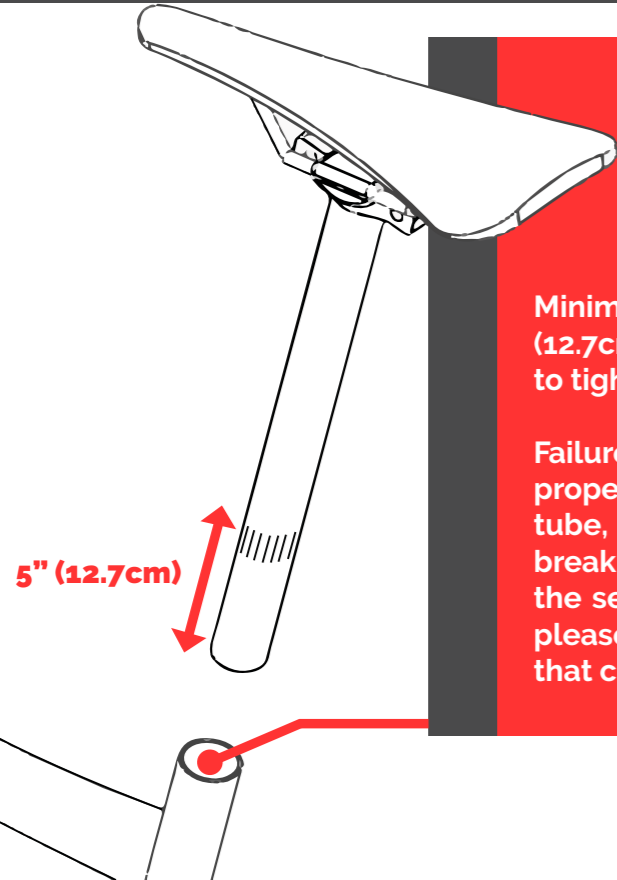

Insert the seatpost into the seat tube and make sure your seat is in at least to the minimum insertion depth which is marked by the vertical lines.

Minimum seatpost insertion depth is 5" (12.7cm). Use the seatpost quick release to tighten the seatpost.

Failure to insert the seat post to the proper depth could overstress the seat tube, which could cause the frame to break and lead to a serious accident. If the seat post is not tall enough for you, please purchase an extra long seat post that can accommodate your height.

STEP 5 BEFORE YOUR FIRST RIDE

Charging port is located on the side of the battery. Lift the rubber seal to expose the charging port.

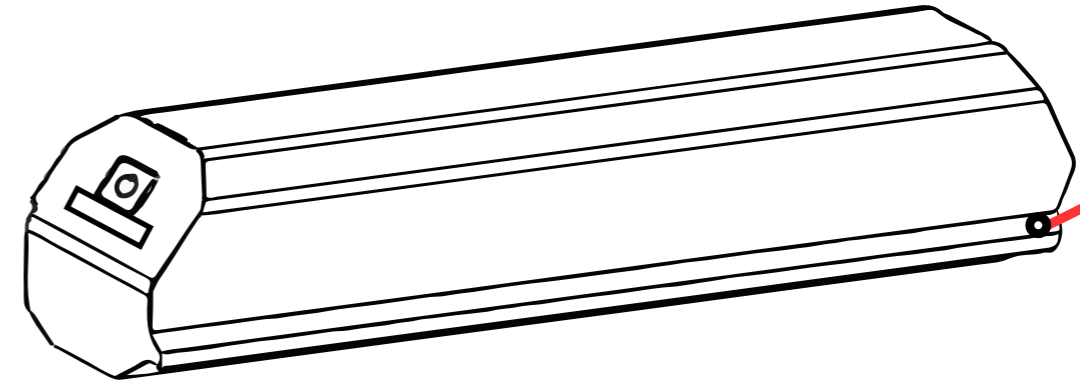

! Make sure you charge the battery fully before your first ride.

TECHNICAL SPECS

BLADE

FRAME

- 27.5" 6 series aluminum alloy
- Integrated battery housing
- Internal cable routing
- Accessory mounts

MOTOR

- **750/1000W** Bafang Mid Motor
- Peak power **1350W**

TIRES

- MAXXIS 27.5" x 2.5" Minion DHF

WHEELS

- SPANK 27.5" OOZY TRAIL 345 BOOST

BATTERY

- 48V 17.5AH (840WH) Lithium Ion cells
- LED charge indicator
- Lockable
- USB Port

DISPLAY

- Backlit LCD with thumb controls

ASSIST

- 9 level pedal assist
- Thumb throttle

SUSPENSION

- Front: ROCK SHOX FS PIKE RCT3 27.5" BOOST, 160mm Travel

BRAKES

- Magura MT5e 4 Piston Hydraulic Disc Brakes
- 203MM Rotors with Electric Motor Cutoff

REAR DERAILLEUR

- SRAM EX1 8 Speed

CASSETTE

- SRAM EX1 8 Speed 11-48T

CHAIN

- SRAM EX1 8 Speed

CHAINRING

- 40T Narrow Wide Anti-Slip

LCD SCREEN

The color LCD has many functions, here we will cover the essentials.

For more information visit flx.bike/manual.

The LCD has been preprogrammed to comply with your local speed regulations. For information on how to change this, please visit the URL above or go to **page 20**.



LCD SCREEN SCREEN & CONTROLS

LCD SCREEN INSTRUCTIONS



To turn on the LCD, press and hold the "Power Button (⏻)" for 3 seconds. Once this is done the "Power Level" section of the screen will display the current level of pedal assist active. The default is 0, and the maximum is 9. The level of pedal assist can be adjusted by pressing the "+" or "-" buttons as appropriate. When the LCD is on, the throttle will also be active, and this can be triggered regardless of the level of pedal assist (1-9) by depressing the throttle lever on the left hand grip of the handlebars.

Additionally, walk-assist mode can be activated by pressing and holding "-" for 3 seconds. This is a single-speed designed to be an average walking pace, **NOT FOR RIDING**.

When full, the "Battery Indicator" will show a full battery icon and numerical indicator "100%". When the battery drops below 10%, the battery icon becomes red, which indicates that it has to be charged.

The headlight, taillight and backlight on the LCD screen can be activated by pressing and holding the "Light (☰)" button for 3 seconds, and it can be turned off the same way.

To charge USB devices via the display's USB port, remove the rubber seal on the bottom of the display and insert any USB charging cable.



LCD SCREEN PROGRAMMING

Please check the default settings on your bike to ensure they are correct and in compliance with local laws.

It is possible to change these defaults by entering the **"Programming Mode"** by fast pressing the **"i"** button 2 times.

The options can be cycled through with **"+"** and **"-"** buttons and adjusted as you see fit. To save and exit navigate to **"Exit"** and press the **"i"** button on the controller.

For the full list of features on the LCD display, please refer to the following:

flx.bike/manual

LCD SCREEN ERROR CODES

| CODE NUMBER | DEFINITION |
|-------------|-------------------------------------|
| 04 | The throttle has not returned home |
| 05 | Throttle fault |
| 07 | Over voltage protection |
| 08 | Motor hall signal cable fault |
| 09 | Motor phase cable fault |
| 10 | Motor temperature sensor fault |
| 11 | Controller temperature sensor fault |
| 12 | Current sensor fault |
| 13 | Battery temperature fault |
| 14 | Motor temperature fault |
| 21 | Speed sensor fault |
| 22 | BMS communication fault |



The LCD has an intelligent on board diagnostics system. If it senses any mechanical or electrical faults it will display an error code. Please refer to these error code definitions to aid with troubleshooting and maintenance.

BATTERY CARE

It is recommended to remove the battery from the bike when storing it for a longer period of time (> 2 weeks). Store the battery in a cool and dry area away from water. The charge left in the battery should be 50% for long storage times.

Cleaning the battery and battery housing should only be done while the battery is disconnected and turned off. To clean use a dry rag or, if need be, a lightly damp rag. DO NOT spray with high-pressured water to prevent damage or possible short-circuiting.

Only charge the battery with the supplied charger as others may cause damage to the battery and increase the possibility of fire or explosion. We recommend placing the battery on a non-flammable surface and charging it during the day in a dry space with a smoke/fire alarm.

Do not store the charger or battery in a wet place or in direct sunlight. Lithium-ion batteries are meant to be recharged with 10%-15% of the charge remaining to prolong the life of the cells.

Note: Based on IATA regulations you are not allowed to ship Lithium-ion batteries this size by air. Please consult a land or sea freight agent for transportation of the battery.

If there appears to be an issue with the charger or battery, stop use immediately and contact either the manufacturer or us at hello@flx.bike.

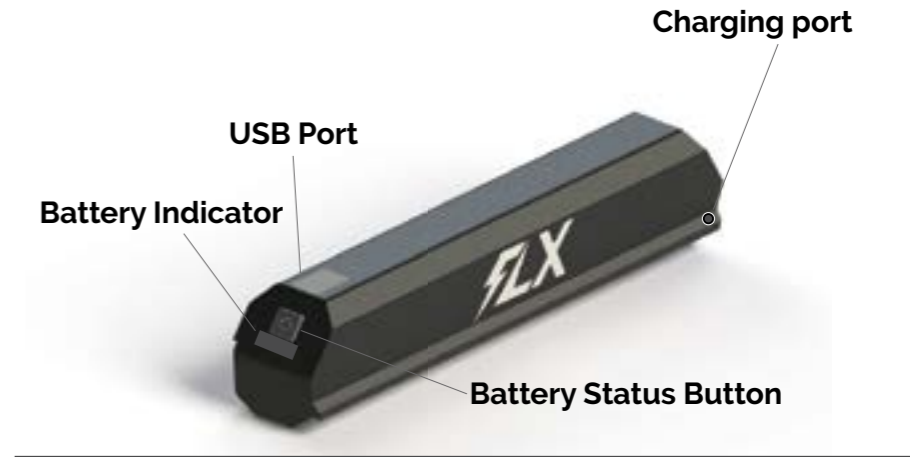



Whenever you service your bike, make sure to remove the battery first. Keeping the chain, shifter, and gear cassette properly lubricated will help to prolong the life of your bike.

The biggest enemy of any bike is rust, so make sure to dry it off after a wet ride and store it in a dry place. In general, wiping down your bike after a rough ride with a damp rag should be enough to keep it looking great, just make sure to be careful around the electronics.

Do not turn on the bike when the brake levers are depressed as this will trigger the faulty brake sensor and disable the motor.

Inspect the bolts on a regular basis, to ensure that they are tight and all components are secure. This is especially important if you are riding in demanding conditions. **As with all bikes pay particular attention to the crank bolts, as they pose the highest risk of loosening.**

Regularly check the brake pads, the provided Tektro pads should be replaced if they have:

- **Been contaminated**
- **Less than .8mm of material**
- **Cracks or deformation**

To replace the brake pads or perform other maintenance take it to a qualified professional at your local bike shop.

The bike has a powerful mid-motor which places more stress on the gears than a regular bike. Reducing the force placed on the pedals whilst shifting will prolong the life of the drivetrain.

Properly inflate your tires according to riding conditions. Under-inflated tires are prone to pinch flats, especially if riding off-road or over sharp edges. If you are unsure of the proper pressure, read the tire.



Check the throttle connection underneath the neoprene sleeve if the throttle doesn't work initially.



LEGAL REQUIREMENTS

The regulations for electric bicycles are constantly being revised and may change at any time. Obtain information regarding the current legal requirements at both a general and local level to ensure compliance.

For FLX ebikes, special legal provisions apply for their limit of use. As an ebike they can be used both as a purely mechanical bicycle or as a motor assisted means of transportation, in essence they can operate as a bicycle at times if desired/required. Before riding on public roads or trails with an FLX ebike the user must inform themselves properly on legal requirements enforced in the user's country, state/territory, and city.

This information can be acquired by visiting local ebike retailers, and bicycle or ebike associations. The currently valid, national and local regulations also pertain to age restrictions and specify the minimum age a user must be to drive on which part of the road and whether certain driving permits are required. The regulations for children riding on public roads are also found here. It will be made clear if a helmet is required by law, or if any head- or tail- lights are required.



LEGAL DISCLAIMER

FLX Bike (the Seller) holds no liability whatsoever for any damage - regardless of what type - or injury to any party involved in improper use, handling, or storage of any FLX electric bicycle, or any of their components.

Additionally, the Seller holds no liability whatsoever for any damage - regardless of what type - or injury to any party involved in the improper maintenance of any FLX electric bicycle, or any component therein.

The Seller holds no liability whatsoever if the use of any attachments or additional components (modification/s), either proprietary or third-party, result in any damage - regardless of what type - or injury to any party. This provision extends beyond modifications sold by the Seller and to any modifications, especially in the case that the user does not ensure that the modifications are meant to be used with FLX electric bike or any of the Seller's other products. In the case that a modification approved by the Seller malfunctions due to user error, improper installation, lack of proper maintenance, improper use or use for anything other than the intended use as explained by the manual of the aforementioned modifications and/or the Seller, the Seller holds no liability whatsoever for any damage - regardless of what type - or injury to any party.

LEGAL DETAILS

Technical details in the text and illustrations of the translation of these operating instructions are subject to change. For the most up to date version of this FLX User Manual visit flx.bike/manual or email hello@flx.bike.

Any liability whatsoever by the publisher, editor and other third parties for contributions to this document, FLX User Manual, and any resulting damage - regardless of what type - is hereby fully excluded unless it involves a case of gross negligence.

Copyright

No part of this publication may be reprinted, translated, copied or transmitted in any form or by any means, electronic, mechanical, by hand or otherwise for another business purpose without prior written permission of the author or publisher.



TERMS AND CONDITIONS

These terms and conditions shall apply to all orders entered into by and between any distributor or any end-user of the Goods, whichever the case may be ("Buyer") and FLX BIKE ("Seller"). These terms and conditions and any Seller quotation form submitted herewith or separately shall be collectively referred to hereinafter as the "Agreement." Seller shall accept orders, sell Goods, and do business only upon these terms and conditions. Any additional or different terms in Buyer's purchase order or other purchase documentation are deemed material alterations to this Agreement, and Seller hereby gives notice of its objection to them. The term "Goods" means all items sold and/or provided by Seller to Buyer.

"Price." All prices are subject to change. Prices also do not include any federal, state, or local taxes or other governmental charges upon or with respect to the sale, purchase, manufacture, delivery, storage, processing, use, or consumption of any of the Goods provided hereby. Prices are stated in U.S. dollars. PayPal and all major credit cards are accepted.

"Specifications." Seller may, at its option, make changes in the designs, specifications or components of the Goods to improve the safety of such Goods, or if in Seller's judgment, such changes will be beneficial to their operation, use, or image. FLX BIKE makes every effort to ensure that posted specifications, images, pricing and product availability are as correct and timely as possible. FLX BIKE reserves the right to make any and all changes deemed necessary in the course of business including but not limited to pricing, product specifications, quantities, and product availability.

"Shipping and Delivery." FLX BIKE can ship anywhere there is a notable shipping service (i.e. UPS Ground, FedEx, DHL, etc.). FLX BIKE will not provide information about customs and international fees. Buyer is responsible for researching additional charges for customs and international delivery. Buyer is subject to these additional shipping charges. Title to and risk of loss for the Goods shall pass to Buyer upon delivery of the Goods by Seller to the common carrier for delivery. All time frames provided by Seller, whether verbally or in writing, are good faith estimates of the expected delivery date for the Goods. Seller shall use commercially reasonable efforts to fill Buyer's orders within the time stated but in no event shall Seller be liable for any damages associated with Seller's inability to meet any such time frames or deadlines, including but not limited to incidental or consequential damages arising there from.

"Force Majeure." Seller shall not be responsible for any delay in the delivery of, or failure to deliver, Goods due to causes beyond Seller's reasonable control including, without limitation, acts of God, acts of war or terrorism, enemy actions, hostilities, strikes, labor difficulties, embargoes, non-delivery or late delivery of materials, parts and equipment or transportation delays not caused by the fault of Seller, delays caused by civil authorities, governmental regulations or orders, fire, lightning, natural disasters or any other cause beyond Seller's reasonable control. In the event of any such delay, performance will be postponed by such length of time as may be reasonably necessary to compensate for the delay.

"Assembly." If Buyer purchases any Goods that require assembly, Buyer shall, at its expense, make all arrangements and connections necessary to install and operate the Goods properly. Buyer shall assemble the Goods in accordance with any Seller instructions or recommendations and shall indemnify Seller against any and all damages, demands, suits, causes of action, claims and expenses (including actual attorneys' fees and costs) arising directly or indirectly out of Buyer's failure to properly install the Goods.

"Use of Goods." Buyer is responsible for using and maintaining the Goods properly and safely in accordance with any required laws and/or as set forth in manuals and instruction sheets furnished by Seller.

TERMS AND CONDITIONS

"Warranty." FLX BIKE warrants that all new FLX products are warranted to the Buyer against manufacturing defects in materials and/or workmanship for a period of (1) year from the date of delivery. The warranty period is calculated from the point of delivery. The original receipt of purchase is required to establish proof of purchase and must be provided to FLX BIKE for all warranty claims. FLX BIKE will require the customer to complete a MANDATORY standard procedure for warranty claims that will involve media such as photos and videos to help FLX BIKE after sales staff establish the fault with the product. Only the individual components themselves are covered by the warranty. The removal, assembly, and tuning requirements of the component is borne by the customer making the claim. The costs/inconvenience caused by the loss of use of the product, is not covered whilst the warranty procedure takes place. The warranty for replacement components will be based on the date of delivery. Under no circumstance will a replacement component have a warranty date different than the original date of delivery. If a replacement is necessary due to a defect in materials and/or workmanship, then upon return to FLX, the component will be replaced during the warranty period. FLX will have no obligation under this limited warranty in the event the product is damaged or destroyed as a result of any of the following events: component use on a non FLX product, damage or destruction by abuse; collision; theft; improper maintenance or mishandling of the product; natural forces such as wind, lightning, hail, etc.; any willful or negligent act; penetration, or opening of the product casings in any manner. Replacement will be honored only by FLX. This is FLX's exclusive warranty. No party is granted express or implied authority to change or annul this warranty in any manner. Implied warranty including that of merchant-ability and fitness for a particular purpose are expressly limited in duration to the duration of this warranty. FLX disclaims any liability for special, incidental or consequential damages. This warranty is not meant to suggest or imply that the products cannot be broken or will last forever. It does mean that the product is covered subject to the terms of the warranty. This warranty applies only to the original Buyer of the product and is not transferable to subsequent owners or any other party. This warranty is void if the product is subjected to abuse, neglect, improper repair, improper maintenance, alteration, modification, an accident or other abnormal, excessive, or improper use, at the sole discretion of FLX.

"Warranty Exclusions." This warranty does not cover:

- normal wear and tear
- damage or failure from abuse, neglect, misuse, or accident
- damage from stunt riding, ramp jumping, acrobatics, competitive events, such as bicycle racing, bicycle motocross racing, or similar activities or any activity that is not consistent with the intended use of the product
- damages resulting from improper charging of the battery pack or use of any charger not supplied by FLX
- installation of any parts, accessories, or electrical component(s) not originally intended for or compatible with the product as sold, or any modification of the frame or any component(s) originally supplied; tires, brake pads, chains, lights, motors, battery packs, displays, or vehicle controllers that have been opened for any purpose whatsoever, other than by FLX
- All warranties are void if the product is used for any purpose other than the reasonable intended use of the product. Additionally, this warranty does not cover damage associated with commercial use.
- Aftermarket components or modifications All implied warranties, including the warranties of merchantability and fitness for a particular purpose, are limited in duration to that of the express warranties stated above.

TERMS AND CONDITIONS

****Warranty Procedure.**** Proof of purchase must be provided. To qualify for warranty services, a Warranty Product Return Authorization Number ("WPRAN") must be obtained by the original purchaser from FLX. The original Purchaser must contact a FLX representative to discuss the problem with the product and to obtain a WPRAN. Upon issuance of a WPRAN, the product component(s) must be returned to FLX. The original Purchaser is responsible for the return of the product, undamaged in transit, to FLX for warranty work and for the costs associated with shipping the component(s) when returning them. If FLX BIKE determines a warranty claim is valid and conforms with this warranty, FLX will provide replacement component(s).

For valid warranty claims hereunder, FLX will reimburse the original Purchaser for shipping costs incurred as a result of returning the product to FLX for warranty work at standard ground shipping rates, and FLX will pay for shipping costs to return the product to the original.

****Limited Remedy.**** Unless otherwise provided, the sole remedy under the above warranty, or any implied warranty, is limited to the replacement of defective parts at the sole discretion of FLX BIKE. In no event shall FLX BIKE be responsible for direct, incidental or consequential damages, including, without limitation, damages for personal injury, property damage, or economic losses, whether based on contract, warranty, negligence, product liability, or any other theory. *

Cancellation. Buyer has a 10 day period to cancel an order for a full refund. After the cancellation period, no refunds will be awarded. The Goods will be delivered with no returns.

****Modification.**** Buyer has a 10 day period to modify an order at no additional cost beyond the published price of Goods. After the modification period, Buyer is subject to a minimum \$100 administration fee at manufacturer's discretion. All modifications are subject to availability. There is no guarantee these modifications can be made unless approved by FLX BIKE. To file a modification claim, email hello@flx.bike with your original order confirmation.

****Returns.**** Our extensive quality control means that our products are thoroughly tested and ultra-reliable by industry standards. All products are warranted to work as described on arrival and for the warranty period. If there is a warranty claim, it will be assessed by FLX BIKE and new parts will be delivered upon claim's approval. FLX BIKE will accept the return of warranted components. If there is a major fault with the product, contact FLX BIKE immediately. FLX BIKE will not accept returns for change of mind.

CONTACT US!

SHARE YOUR PICTURES AND EXPERIENCES WITH US AT:

hello@flx.bike



flx.bike
flx.bike/manual
facebook.com/flxbike



