



DM03 Display

Functionality Introduction

Product Name: Intelligent OLED Display

Product Model: DM 03



	Signature	Date
Editor	Leo Liao	2020-06-17
Checked		
Approved		



版本修订历史

Version No.	Reviser	Date	Revision content
V1.01	Leo Liao	2020.06.17	Initial version
	Leo Liao	2020.07.27	Update display coding rules



Content

A Product Introduction.....	4
1. Product name and model.....	4
2. Product Introduction	4
3. Range of application	4
4. Appearance and size	4
5. Display coding rules.....	5
B Product manual.....	6
1. Specifications	6
2. Function overview	6
3. Installation	7
4. Interface	8
4.1 Boot interface.....	8
4.2 Basic interface and operation.....	9
4.3 Function interface introduction.....	9
Boot interface and basic function interface	9
Other function interfaces.....	10
Setting interface	11
5. Button definition	12
5.1 Button name:.....	12
5.2 Definition of button operation	12
6. Basic function operation.....	13
6.1 Turn on/off the display.....	13
6.2 Assist level switch	13
6.3 Information switch	14
6.4 Light control function	14
6.5 Speed information switch	15
6.6 Walk assist function	15
6.7 Battery power indicator and assist power output.....	15
7. Setting Function	17
8. Advanced setting functions	19
*Warning	19
Advanced setting operation instructions.....	19
Reference table for the circumference value corresponding to common wheel diameters	23
9. Data clearance	23
10. Error information.....	24
11. Wire definition	25
11.1 Standard wires definition:	25
11.2 Standard conversion wire specifications:	26
C Package specifications.....	26
D Note.....	27



A Product Introduction

1. Product name and model

OLED display of electric power assist bikes

Product model: DM03

- DM03 includes two versions of UART communication and CAN BUS communication
DM03_U corresponds to UART communication version;
DM03_C corresponds to CAN BUS communication version.
- All DM03 products are equipped with Bluetooth in its hardware

2. Product Introduction

- ✧ Tempered glass screen with 2.5D chamfered edge
- ✧ 1.3 inch high brightness B/W monochrome OLED screen
- ✧ Enlarged operating space plus ergonomic button design
- ✧ IP65 waterproof level, excellent for outdoor use
- ✧ Built-in Bluetooth function, compatible with CAN-BUS and UART communication
- ✧ Service Tool function for fast firmware upgrade, parameter setting, and easy maintenance.

3. Range of application

Suitable for all E-bikes that comply with EN15194 standard

4. Appearance and size

The shell material of DM03 is PC+GF10, the screen is made of imported tempered glass with 2.5D chamfering technology. This product is suitable to be installed on the left side of horizontal tube

with a handlebar size of $\phi 22.2\text{mm}$.



5. Display coding rules



DM03-C01M020340001
A08.01-36V2570XX

As shown as above picture:

DM03-C01M020340001.

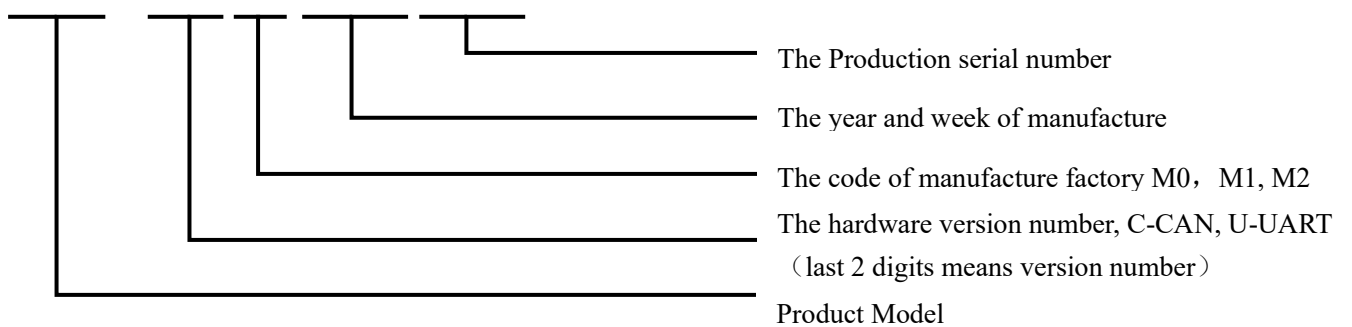

A08. 01-36V2570XX

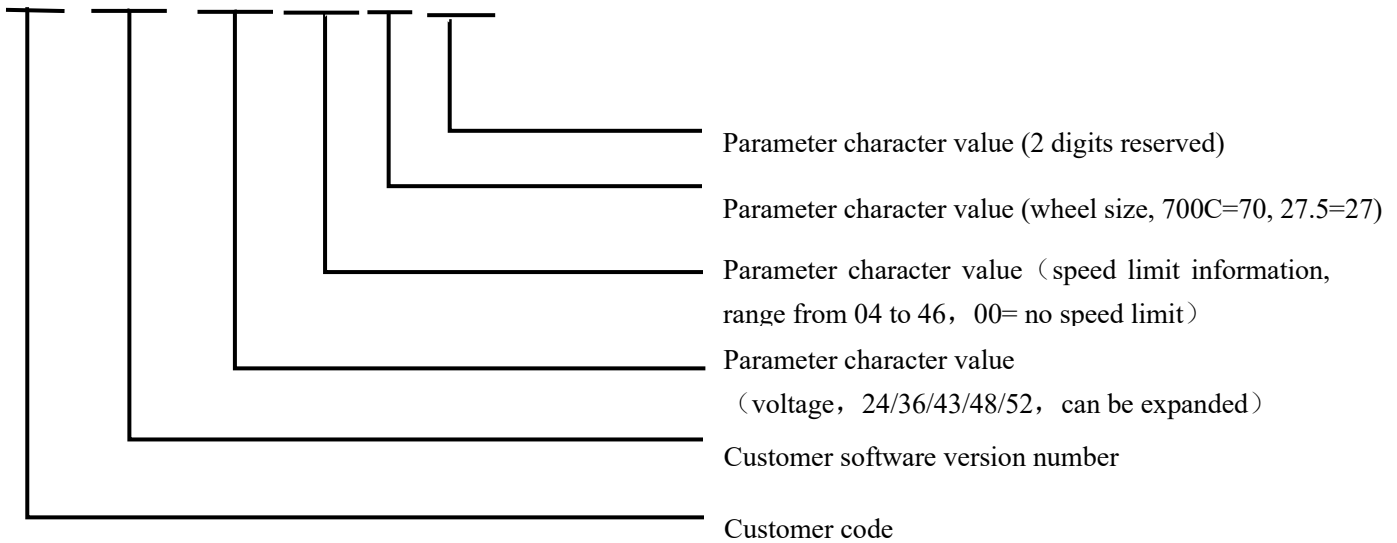

B Product manual

1. Specifications

- ① Power supply: DC 24V/36V/48V
- ② Rated current: 18 mA
- ③ Shutdown leakage current: <1uA
- ④ Screen specification: 1.3" OLED
- ⑤ Communication method: UART/ CAN-BUS 2 modes
- ⑥ Operating temperature: -20° C ~ 60° C
- ⑦ Storage temperature: -30° C ~ 80° C
- ⑧ Waterproof level: IP65

2. Function overview

- ① Four buttons, ergonomic design
- ② Selective digital and icon power assist gear for high visibility

 杭州威狐智能科技有限公司 Hangzhou VeloFox Intelligent Technology Co., Ltd.	文件编号	
	版本号	1.01

- ③ Unit: Km / miles
- ④ Speed: Real-time speed (SPEED)、maximum speed (MAX)、average speed (AVG)
- ⑤ Battery indicator with percentage display
- ⑥ Range: Endurance mileage (*available if BMS provides necessary info)
- ⑦ Headlight on/off status indication and control
- ⑧ Mileage: Subtotal mileage(TRIP), total mileage (ODO)
- ⑨ Walk assist function
- ⑩ Parameters setting and advanced setting
- ⑪ Error code indication

3. Installation

- ① Open the display locking clip, set the display in the left handlebar (standard handlebar size:Φ22.2)
Adjust to a position easy to operate, using M3 hex set to screws and tighten. Tightening torque: 0.8N.m.
***Note: Damage caused by excessive torque is not covered by the warranty.**
- ② Connect the 5 pin plug to the docking plug of the controller as marked

4. Interface

4.1 Boot interface



Boot logo interface is displayed for 3 seconds after display is turned on. When the communication connection is established, display enters the main interface which shows information obtained from the controller. (All data displayed is following communication protocol provided by the customer)

4.2 Basic interface and operation



- ① Display adopts 4 buttons: power button、M button、 \wedge button、 \vee button
- ② Standard Outlet is a board end connector, which is convenient for after-sales maintenance and replacement
- ③ 1.3 inch OLED dot matrix display meets the need for customization of the boot interface and UI interface

4.3 Function interface introduction

Boot interface and basic function interface

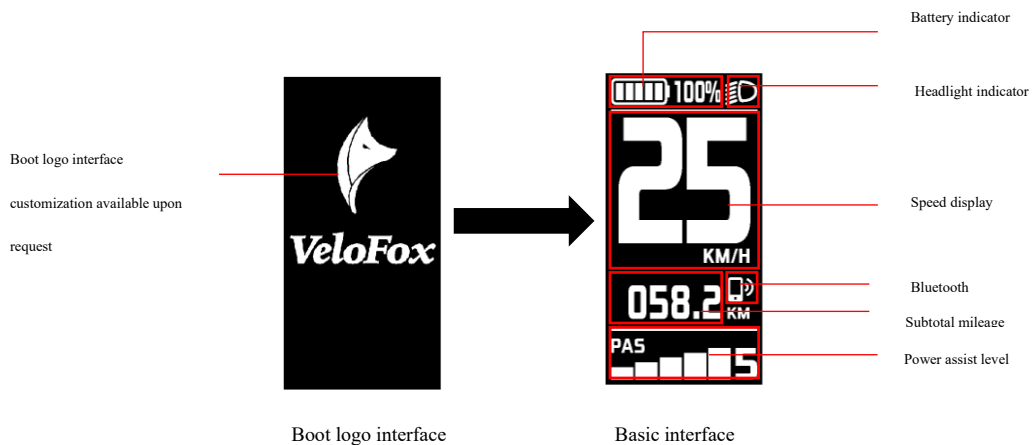

Boot logo interface is displayed for 3 seconds after display is turned on. When the

 Hangzhou VeloFox Intelligent Technology Co., Ltd.	杭州威狐智能科技有限公司	文件编号	
		版本号	1.01

communication connection is established, display enters the main interface, showing real-time information stored in the controller and battery BMS according to communication protocol. (Battery indicator will not show battery percentage if BMS info is not available)

Other function interfaces

Function interface I

Function interface I mainly displays speed information, including average speed, maximum speed and TRIP info which is subtotal mileages as shown on basic interface. Speed display value has 3 digits, maximum value is 99.9KM/H, including one digit after the decimal point. Subtotal mileage TRIP value has 4 digits, including one digit after the decimal point. After 9999.9 KM is exceeded, the decimal point is not indicated, and a 5-digit mileage value is displayed directly, with a maximum value of 99999km. After the maximum value is exceeded, the value is shown as the actual mileage value deducted by 100,000.

Data on function interface I can be cleared by a key operation



Function interface II

The function interface II mainly displays mileage information, including endurance mileage and total mileage information. The endurance mileage is calculated by controller based on battery BMS capacity. If the controller does not provide the endurance mileage info, it will be displayed as 000.0KM. Total mileage is usually 4 digits, including one digit after decimal point. After 9999.9KM is exceeded, the decimal point is not indicated, and a 5-digit mileage value is displayed directly, with a maximum value of 99999km. After the maximum value is exceeded, the value is shown as the actual mileage value deducted by 100,000.

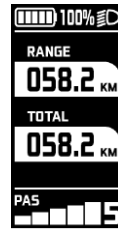

Walk assist interface

Long press  button to enter the walk assist mode, interface as shown below:









Error code indication interface

When the display receives the error info returned by controller, it will show detailed error code on interface, indicating relevant electrical system fault information. The error code will be displayed numerically in the speed display area.



Setting interface

Within 10s after turning on display, long press M button to enter setting interface, short press ,  to switch between setting interfaces. In any setting interfaces, short press M to enter parameter editing state, which offers two modes, picking and selecting. The picking mode is indicated by triangle cursor on the right, and selecting mode is indicated by parameter shown on white background. Short press ,  to modify the parameters to edit. Long press M button to confirm and exit editing state, and long press M button again to return to previous page.

Short press ,  button to enter into each setting item accordingly.

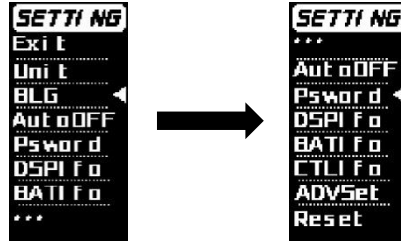

Setting interface level 1 menu page

For more setting operation illustration , please refer to part 7

5. Button definition

5.1 Button name:



Power button: Turn on/off the display

Adjust button: Adjust the assisting power level during riding and switch functions

Long press the adjust buttons to perform specific function operation

Mode button: Switch interface functions and enter into parameter setting interface



5.2 Definition of button operation

Operation Type	Description
----------------	-------------

Short press	Press the button and soon released, while the button is released, the function activated accordingly
Long press	Press the button and hold, when the hold time exceeds the setting time (generally 2 seconds), the function activated accordingly.

6. Basic function operation

6.1 Turn on/off the display

To turn on, long press  button, when the display and controller are well-connected, until boot logo interface appears and shortly enters the basic interface. To turn off, long press  button, when display is on, until display is turned off. If the rider does not perform any operation on the display within set shutdown time, while speed is 0, and current is less than 1A, then display will be turned off automatically. Set shutdown time is self-defined by user.

6.2 Assist level switch

During normal working state, short press 、 buttons to switch assist level, and change assist mode

*** Power assist display can employ any of the following three modes. Please indicate your choice of mode in the order, or you can modify and choose it through advanced setting and auxiliary tool.**

Three types of power assist display modes:

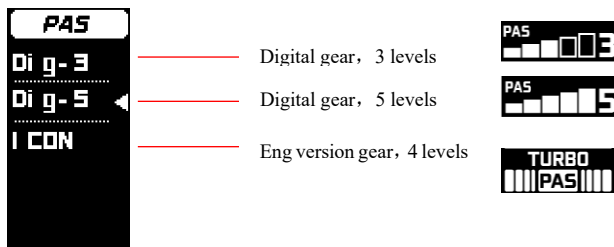



Digital gear levels:



English version gear levels:

 杭州威狐智能科技有限公司 Hangzhou VeloFox Intelligent Technology Co., Ltd.	文件编号	
	版本号	1.01



Short press 、 button to switch assist level. Switching level is not cycled, that is, after reaching 5th level, short press  button to return to off level. It's the same when adjusting up.

6.3 Information switch

In a power-on state, short press M button to switch alternately from basic interface, function interface I, and function interface II. In normal riding state, if the bike speed is greater than 0, and display is not in the basic interface, then basic interface will be automatically returned to after 5 s no operation on M button.

Function interface I displays the average speed, maximum speed and subtotal TRIP mileage;

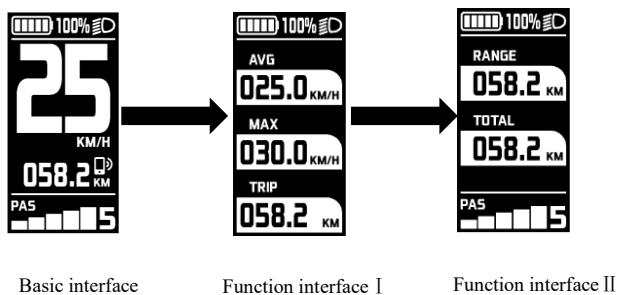

Function interface II displays the endurance mileage and total mileage.

The switching process of each interface, as shown below:



***If BMS communication is not supported, display cannot obtain accurate RANGE information, and the value of RANGE is displayed as 000.0KM**

6.4 Light control function

In a power-on state, long press  button to turn on the front light, at the meantime, a light icon on top left corner of screen will appear indicating light-on status. Long press  button to turn the lights off.

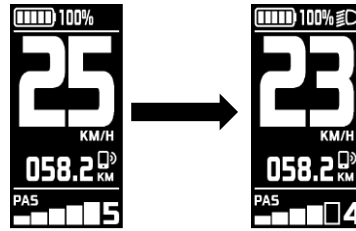

 杭州威狐智能科技有限公司 Hangzhou VeloFox Intelligent Technology Co., Ltd.	文件编号	
	版本号	1.01



6.5 Speed information switch

In basic function interface, display shows the real-time speed, average speed, and maximum speed. Users can switch info by short press M button. Check 6.3 for more information switch.

6.6 Walk assist function

When speed is 0, long press  button to enter walk assist mode, motor output according to the setting speed and control the actual walk speed, display shows the walk assist icon  and the real-time speed. Release  button or any other button to exit walk assist mode, the motor is turned off, and the display gets back to the basic interface. Walk assist interface, shown as below:



6.7 Battery power indicator and assist power output

Battery power information is divided into battery bar indication and remaining percentage indication. When battery power is normal, battery capacity is divided into 5 bars. Before communication is established, battery percentage is not displayed, and the power bar is full and blinks at 2Hz. After battery info is acquired, power bar will stop blinking, and displays the power percentage. If communication is not successful within 5s, it will stop blinking and no power percentage will be displayed.







After battery capacity is lower than 5% or the voltage is lower than low voltage value, display will enter low-voltage mode. In this mode battery level showed level 0 and border blink at 1Hz, with

no power output from the motor, and disabled assist level switch. Power assist level is displayed as OFF or 0.

To get out of low-voltage mode, reset, and increase the voltage above low-voltage value and battery capacity above 5%.

Percentage of battery power (C) and power level table

(Require battery % info from BMS or controller):

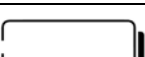
SOC	Battery level	Description
$80\% \leq \text{SOC}$		Full battery level 5
$60\% \leq \text{SOC} < 80\%$		Level 4
$40\% \leq \text{SOC} < 60\%$		Level 3
$20\% \leq \text{SOC} < 40\%$		Level 2
$10\% \leq \text{SOC} < 20\%$		Level 1
$5\% \leq \text{SOC} < 10\%$		Level 0
$0\% \leq \text{SOC} < 5\%$		Level 0 and icon blink at 1Hz



● Remarks about battery indicator:

When there is a battery communication error:



1. Display will estimate the power according to the voltage and show the battery level accordingly;
2. No battery percentage information shown;
3. Range information will not be displayed;
4. If the voltage is lower than the low-voltage value, the effect of the current on voltage needs to be considered when converting to voltage at 0 current

7. Setting Function

Display provides specific parameter setting functions. The optional items of setting function will be deleted according to different market and product standards. The following is the complete parameter setting, information reading function description under the default state of display. Please contact our sales and technical support team for confirmation in case of any discrepancies.

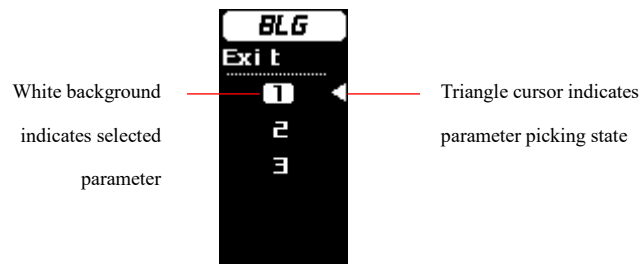
Within 10s after turning on display, long press M button to enter setting interface, short press 、 button to switch between setting interfaces. In any setting interfaces, short press M button to enter parameter editing state, the triangle cursor on the right side indicates parameter picking state. Except for the first-level, parameter setting mode is indicated by parameters shown on white background, as shown below:









Short press 、 button to edit parameters. Long press M button to confirm parameter selection.

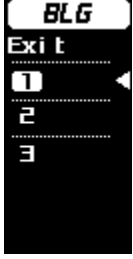

Long press M button again to exit and return to previous page. In any interface of the setting mode, short press M to enter next level, and long press M button to return to the previous menu.

Setting interface firstly enter the first-level parameter setting interface, description of each parameter is as follows:

Setting items	Interface	Description	Setting data	Remark
Unit Setting		UNIT=Unit	Value=KM/H MPH	Default Value=KM/H KM/H—Metric MPH—Imperial



<p>Backlight level setting</p>		<p>BLG=Backlight</p>	<p>Value= 1, back light level 60% Value= 2 Back light level 80% Value= 3 Back light level 100%</p>	<p>Default Value= 1</p>
<p>Auto shutdown time</p>		<p>AutoOFF= Auto sleep</p>	<p>Value=OFF,5-30 min</p>	<p>Default Value=5min Step=5 min OFF means no auto shutdown</p>
<p>Power-on password setting</p>		<p>Psword=Password</p>	<p>Value= OFF and ON; When is ON, user is allowed to set 4-digit password</p>	<p>Default value: OFF</p>
<p>Display info</p>		<p>DSPIFO=display information</p>	<p>Read-only</p>	<p>According to communication protocol</p>
<p>Battery info</p>		<p>BATIFO=battery information</p>	<p>Read-only</p>	<p>According to communication protocol</p>
<p>Controller Info</p>		<p>CTLIFO=controller information</p>	<p>Read-only</p>	<p>According to communication protocol</p>

*Advanced setting options		ADVSET=Advanced setting	Go to advanced setting secondary parameter setting interface	See advanced settings
Reset to factory setting		RESET	Reset	All parameters will be restored to factory setting



8. Advanced setting functions

*Warning

The advanced setting function is based on specific protocol content, allowing to modify and set the controller and system parameter through display side. This feature is only available to specific groups of people, such as bike manufacturers, dealers and other entities with professional technical capabilities. Debugging and maintenance are allowed through advanced setting functions. In case of improper parameter setting or other setting problems, the whole system will work improperly or even have failure problems. **Please be cautious about whom to open this feature to.**

Advanced settings require a specific password, if you need to use this feature, please communicate with our company sales and technical support team to confirm compatibility with your current hardware version. At the meantime, please confirm with our sales and technical support team for adequate maintenance capacity, before obtaining the password.

Advanced setting operation instructions

After selecting the advanced setting in the first-level menu, short press M button to enter the login password. Short press M button to select the corresponding password digit in the 4-digit password field. The selected password digits will be highlighted with a white background. Short press 、 to edit password value, and short press M button again to confirm the input. The password input interface is as follows:





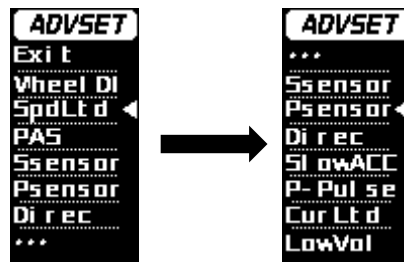

After the password is typed correctly, advanced setting is entered, divided into two-page contents. Short press \wedge 、 \vee to pick and select, triangle cursor on the right indicates selected object.



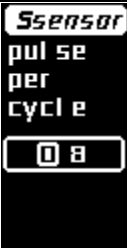
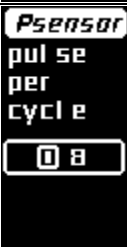

Advanced setting functions descriptions:

Setting item	Interface	Description	Setting data	Remark
Wheel size setting		WheelDI=Wheel diameter	Value=12, 14, 16, 20, 24, 26, 27, 27.5, 700C, 28, *29, *CCF (*value is optional)	Default value 26
Speed limitation setting		SpdLtd=Speed limitation	Value= 5 to 46	Default Value=25 Step=1
Power assist display setting		PAS= Pedal assistant Mode	Value= Dig-3; Dig-5; ICON	Dig-3: Digital 3 gear levels Dig-5: Digital 5 gear levels ICON: Eng version gears



Power assist level setting		PAS= Pedal assistant Level	Value= L1 to L5; 0-100%	L1-L5 Power assist level corresponding to each gear Step=1%
Speed magnet numbers		Ssensor=Speed sensor	Value= 1--12	Default value: 1 Step=1; magnets detected by motor
Power assist magnet number		P-Sensor= PAS sensor	Value= 1-64	Default value: 12 Step=1; Power assist magnet number
Power Assist Magnet direction		Direc= PAS sensor direction	Value= F or R	F=Forward R=Reversed Signal direction of sensor, can be adjusted corresponding to right or left instalation
Slow acceleration		Slow-ACC= slow acceleration	Value= 0-3	Default value: 0
Number of poles for power assist magnet		P-Pulse=assistance started pulse	Value= 2-63	Default Value: 2 Step=1 Number of starting magnets

Current limit setting		CurLtd= current limitation	Value= 0-31.5A	Default Value: 12 Step=0.5A Controller's current limit setting
System voltage setting		SysVol= select system voltage	Value= 24V/36V/48V	Default value: 36V Choose system voltage
Low voltage protection setting		LowVol= low voltage level	Value= 10.0-52.0V	Default value: 31.5V Step=0.5V Select the low-voltage value for protection

* Note: The wheel diameter option CCF is the wheel diameter perimeter setting, which needs to be supported by the controller communication protocol. Parameter 29 = wheel diameter of 29 inches, which needs to be supported by a corresponding controller communication protocol. When the CCF value is selected for the wheel diameter parameter, customer is allowed to customize the wheel diameter circumference value (four-digit length value in mm).

Wheel diameter input operation: Short press \wedge 、 \vee button to enter the parameter value, short press M button to switch to the next number, long press M button to confirm each digit input. After confirming the wheel diameter value input, long press M button to exit the current setting and return to previous menu. The type of wheel diameter configuration will be recorded to the controller. If customer confirms wheel diameter CCF option, then CCF page will be displayed directly when entering the wheel diameter setting.



Reference table for the circumference value corresponding to common wheel diameters

C ETRTO			ETRTO		
16 x 1.75 x 2			16 x 1.75 x 2		
		kmh mph			kmh mph
47-305	16x1.75x2	1272	32-630	27x1 1/4	2199
47-406	20x1.75x2	1590	28-630	27x1 1/4 Fifty	2174
37-540	24x1 3/8 A	1948	40-622	28x1.5	2224
47-507	24x1.75x2	1907	47-622	28x1.75	2268
23-571	26x1	1973	40-635	28x1 1/2	2265
40-559	26x1.5	2026	37-622	28x1 3/8x1 5/8	2205
44-559	26x1.6	2051	18-622	700x18C	2102
47-559	26x1.75x2	2070	20-622	700x20C	2114
50-559	26x1.9	2089	23-622	700x23C	2133
54-559	26x2.00	2114	25-622	700x25C	2146
57-559	26x2.125	2133	28-622	700x28C	2149
37-590	26x1 3/8	2105	32-622	700x32C	2174
37-584	26x1 3/8x1 1/2	2086	37-622	700x35C	2205
20-571	26x3/4	1954	40-622	700x40C	2224
	14x1.75	1046		12x1.75	957

9. Data clearance

Data clearance is aimed at the removal of data information such as subtotal mileage TRIP, average speed, and maximum speed. 10s after display is turned on when display is at function interface I, long press M button to show data clearance window, short press \wedge 、 \vee button to select accordingly. To remove the pop-up clearance window, long press M button or remain no operation for 30s.



After clearance, the subtotal mileage TRIP is 0, average speed and max speed is 0. ODO information can't be cleaned manually on the display, professional service tools are required.

10. Error information

Display can warn bike faults. When faults are detected, error code will be shown on interface and blink at 1Hz. When error code is shown, button functions will not be affected, meaning interfaces can be shown normally by pressing buttons. If no button operation after 5s, the display will returns to the error code interface.

Error code interface as shown below:



Error code information table:

Error code	Error description	Suggest operation
"04" shown at speed	throttle doesn't turn back to zero position (stay on the high position)	Check if the throttle turned back
"05" shown at speed	throttle failure	Check throttle
"07" shown at speed	overvoltage protection	Check battery voltage
"08" shown at speed	failure of motor's hall signal wire	Check motor
"09" shown at speed	failure of motor's phase wire	Check motor
"11" shown at speed	failure of the motor's temperature sensor	Check controller
"12" shown at speed	failure of the current sensor	Check controller
"13" shown at speed	failure of the temperature of the battery	Check battery
"14" shown at speed	Controller temperature is too high, and reaches the protection point	Check motor
"21" shown at speed	failure of the speed sensor	Check the install position of the speed sensor
"22" shown at speed	Failure of BMS communication	Change battery
"30" shown at speed	communication failure	Check connector to controller

(* The corresponding error codes of different system protocols are different. If the error code appears, please communicate with our sales and technical support team to verify and confirm!)

11. Wire definition

11.1 Standard wires definition:

The standard outlet of the display is in the form of a board end plug-in. The standard outlet needs to match the corresponding conversion wire. Velofox has set a corresponding standard for conversion wire length and interface standards. If the standard setting cannot be met, specially customized conversion wires are required.

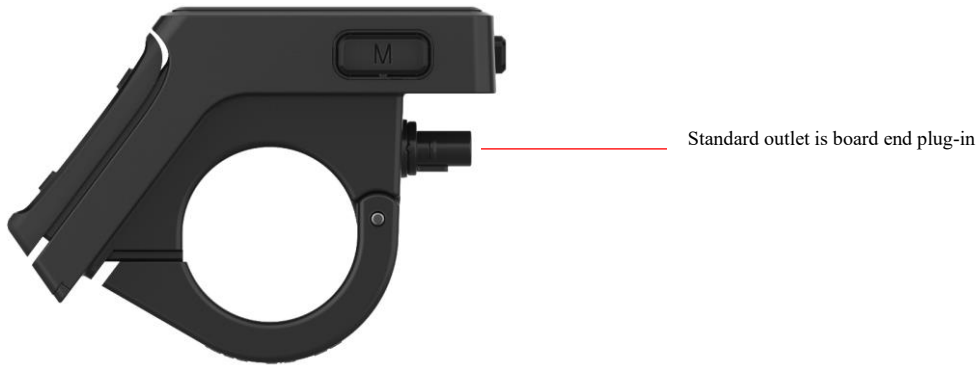

DM03 offers two modes of outlet: board end plug-in and non-board end plug-in. The non-board end plug-in mode is a conventional way for direct cable access to the product.

Standard outlet in a sample is shown in the figure below:

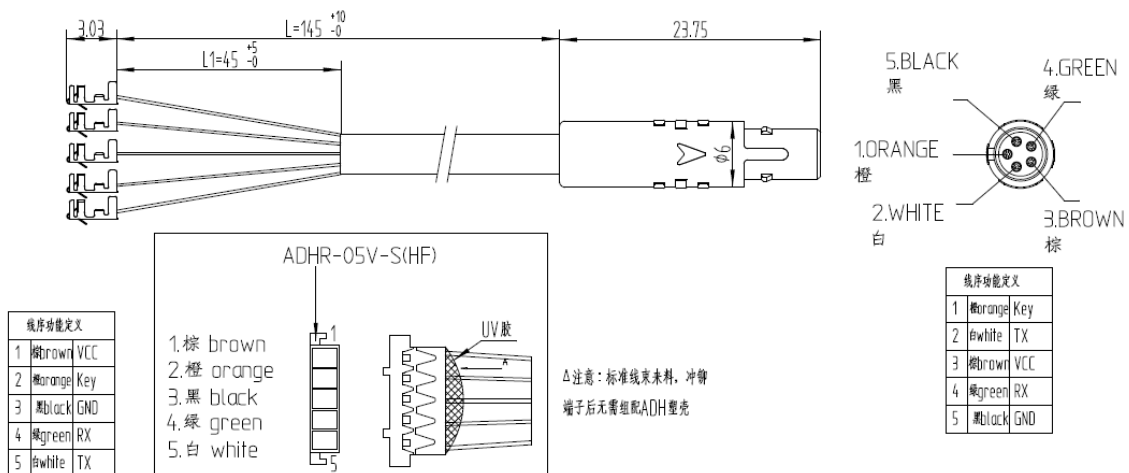

Table 1 Standard wire definition

No.	Color	Function
-----	-------	----------



1	Orange(KP)	Power lock control wire
2	White(TX)	Data transmission wire of display
3	Brown(VCC)	Power wire of display
4	Green(RX)	Data receiving wire of display
5	Black(GND)	GND of display
6	reserve	reserve

11.2 Standard conversion wire specifications:

Adaptor-C2H:

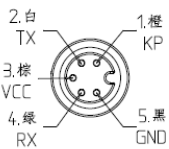

线序功能定义	
1	Orange Key
2	White TX
3	Brown VCC
4	Green RX
5	Black GND

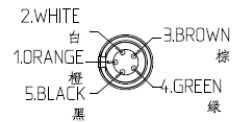
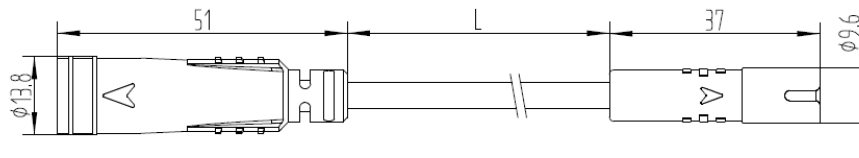

线序功能定义	
1	Orange Key
2	White TX
3	Brown VCC
4	Green RX
5	Black GND

线长允许根据客户订单调整，优先选用推荐线长尺寸，推荐规格如下：

L<mm>	50	100	150	350	550	650	850
-------	----	-----	-----	-----	-----	-----	-----

Adaptor-C2J:

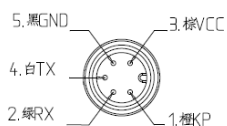

线序功能定义	
1	Orange Key
2	Green RX
3	Brown VCC
4	White TX
5	Black GND

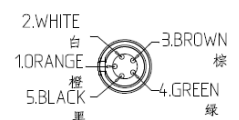
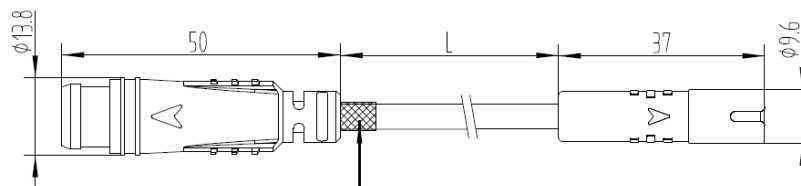

线序功能定义	
1	Orange Key
2	White TX
3	Brown VCC
4	Green RX
5	Black GND

线长允许根据客户订单调整，优先选用推荐线长尺寸，推荐规格如下：

L<mm>	50	100	150	350	550	650	850
-------	----	-----	-----	-----	-----	-----	-----

C Package specifications

Standard delivery, in double corrugated box packaging. Inner layer is double corrugated septum plus EPE foam product bag.



Outer box size: 580*390*168mm (L*W*H)

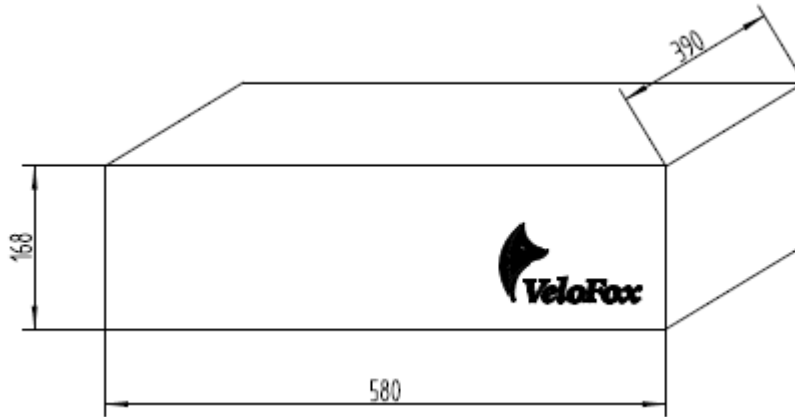

D Note

- ✧ In the use of the display, pay attention to the security, do not plug the display in and out the when the power is on;
- ✧ Try to avoid exposure in harsh environments like heavy rain, heavy snow, and strong sunlight
- ✧ When the display can't be used normally, it should be sent to repair as soon as possible