

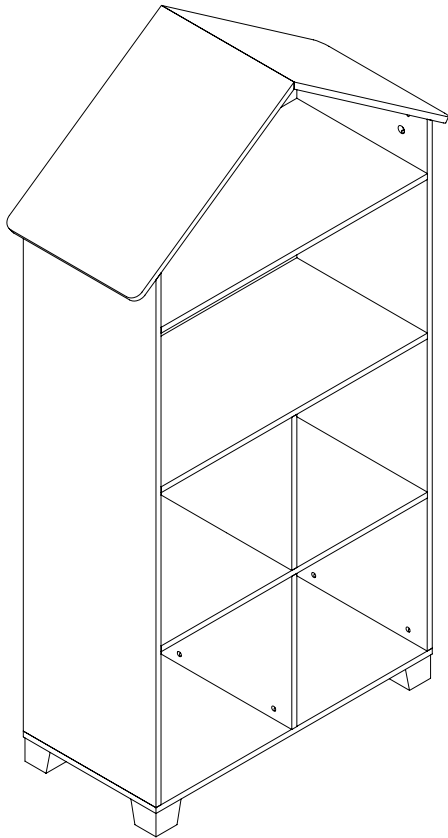

gltc.co.uk

Large Townhouse Bookcase L5289



Assembly Difficulty



easy - medium - hard



Two-person job

V2

16/03/22

Thank you for shopping with GLTC, we hope you enjoy having this product in your home.

We know assembling furniture, toys or accessories is not everyone's favourite way to spend their time, so we've tried to make assembling this item as quick and painless as possible.

A few important pointers before you start:

- Please read the instructions right through before you start, and check that all the components have been included in the pack; we find separating all the hardware into piles makes it easier to be sure that everything is present and correct.
- Make sure you have the right tools. Allen keys are provided if required, but screw drivers and other tools are not. You'll find details of the tools you need at the beginning of the instructions.
- It's a good idea to build the unit in the room where you are going to be using it, to avoid the need to move it after it's been assembled.
- Do not throw away any packing materials until assembly is complete, just in case you accidentally discard smaller parts or hardware.

WARNING!

IN ORDER TO PREVENT OVERTURNING THIS PRODUCT MUST BE USED WITH THE WALL ATTACHMENT DEVICE PROVIDED.

Please see further information in the assembly manual and on the back panel.

Safety Warnings:

- Adult assembly required.
- Unassembled product contains small parts which may present a choking hazard.
- Children should be kept away from the product during assembly to avoid any possible risk of injury.
- Assemble and use on a flat and level surface.
- DO NOT use power tools in the assembly of this product as there is a risk of over-tightening and consequently splitting of the wood.
- To avoid possible injury from tipping, DO NOT allow children to climb on the product.
- Maximum shelf weight 10Kgs DO NOT overload.
- **WARNING! FURNITURE TIPPING RISK.** Serious or fatal crushing injuries can occur from furniture tipping over. Ensure you secure this furniture product to the wall before you use it, using the kit provided.
- If you have not received an anti-tip kit with your product please contact Customer services.
- Wall fixings not included. Please use appropriate fixings that are suitable for the wall type. If in doubt, please seek professional advice.
- Check all fixtures and fittings regularly and tighten as necessary.
- PLEASE RETAIN THESE INSTRUCTIONS FOR FUTURE REFERENCE.

Customer Service:

- If you find that any components are missing or damaged, please do not begin assembly and do not use the item. Please contact GLTC Customer Services on **0344 848 6000** immediately.
- We do stock spare hardware packs at our warehouse, so we should be able to send you a replacement pack immediately if required.

Product Care:

- Wipe clean using a soft damp cloth followed by a dry cloth.
- Do NOT use cleaning products which contain ammonia, solvents or abrasive material.
- Do NOT expose the item to extremes of heat and humidity.
- Regularly check all fastenings, fixtures and fittings to ensure that they are properly tightened.





Could we do better?

If there is anything you think could be improved in these instructions or in the assembly of this product we'd be grateful if you could let us know; we'll pass any helpful hints and tips on to other customers via our website and update the instructions.

All you need to do is drop us a line at [**instructions@gltc.co.uk**](mailto:instructions@gltc.co.uk)

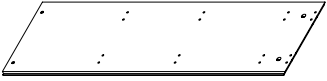
Thank you

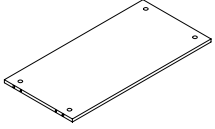
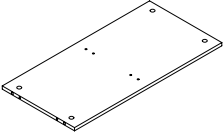
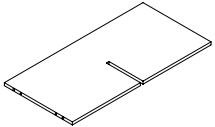
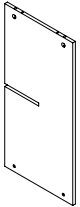
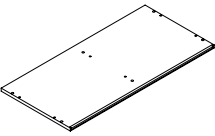
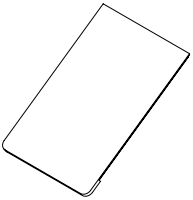
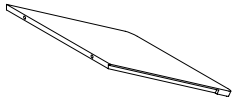





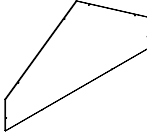
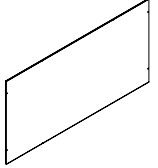
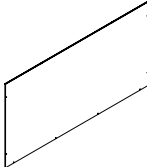

Component Check List

<p>A</p>  <p>1x Side Panel</p>	<p>B</p>  <p>1x Side Panel</p>
<p>C</p>  <p>1x Upper Shelf</p>	<p>D</p>  <p>1x Mid Shelf</p>
<p>E</p>  <p>1x Horizontal Slotting Divider</p>	<p>F</p>  <p>1x Vertical Slotting Divider</p>
<p>G</p>  <p>1x Base Panel</p>	<p>H</p>  <p>1x Roof Panel</p>
<p>I</p>  <p>1x Roof Panel</p>	<p>J</p>  <p>4x Feet</p>

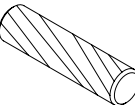
Component Check List

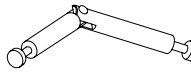
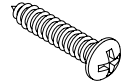
<p>K</p>  <p>1x Upper Back Panel</p>	<p>L</p>  <p>2x Mid Back Panels</p>
<p>M</p>  <p>1x Lower Back Panel</p>	

Hardware Check List

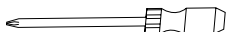
<p>#1</p>  <p>22x Cam Locks</p>	<p>#2</p>  <p>14x Cam Dowels</p>
<p>#3</p>  <p>28x Wooden Dowels</p>	<p>#4</p>  <p>4x Pivoting Cam Dowels</p>
<p>#5</p>  <p>2x Double-Ended Cam Dowels</p>	<p>#6</p>  <p>28x Back Panel Screws</p>
<p>#7</p>  <p>10x Crosshead Bolts</p>	<p>#8</p>  <p>6x Barrel Nuts</p>
<p>#9</p>  <p>1x Anti Tip kit</p>	<p>You will need (not supplied) Phillips Head Screwdriver.</p> 

Hardware for Step 1:



12x #2 Cam Dowels

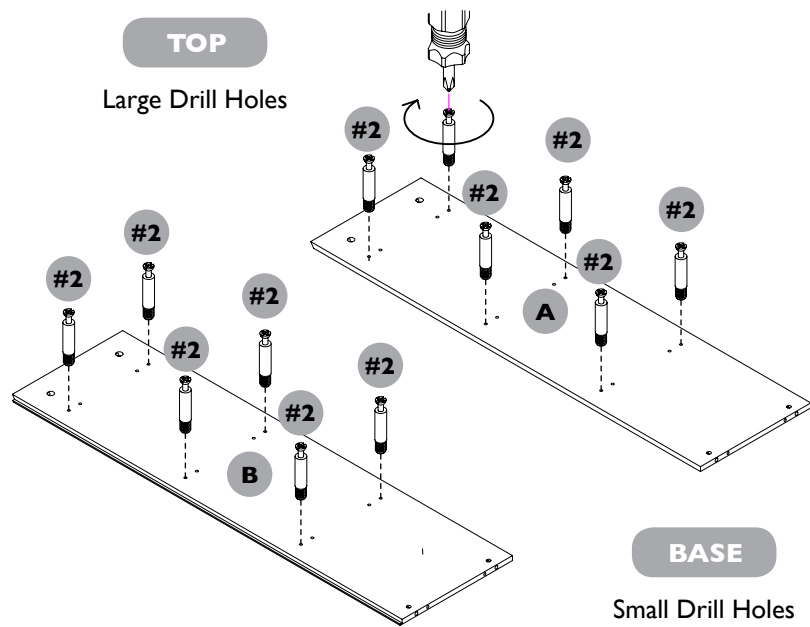

STEP 1:

Working on a protective surface such as a carpet or rug, take both side panels (A & B) and position with drill holes facing up.

Using a Philips Screwdriver, insert 6x cam dowels (#2) into the outer holes of each group of drill holes on BOTH panels.

Please note the 'top' of both panels have the larger drill holes near the edge.

TOP
Large Drill Holes

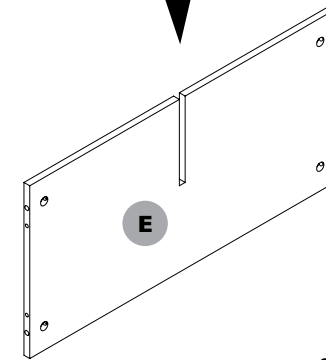
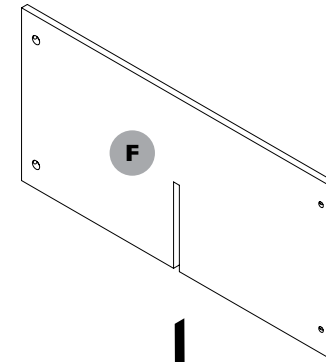

BASE
Small Drill Holes

STEP 2:

Please note, you are building this unit **BACK UP**.

Take slotting divider panels (E & F) and slot together.

Ensure the panels are positioned as shown with the divider panel (F) in the vertical position and the smaller holes pointing towards what will become the base. Also ensure the small drill holes on the edges of both panels are facing up.

Using Cam Locks:

When inserting into the panel, ensure that each cam lock's arrow is pointing towards the drill hole on the side edge of the panel & the dowel that it will be receiving.

When the panels are in the connected position, using a screwdriver, turn the cam lock in a clockwise direction to lock and secure.

Hardware for Step 3:

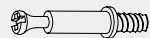

2x #2 Cam Dowels



2x #1 Cam Locks



2x #3 Wooden Dowels

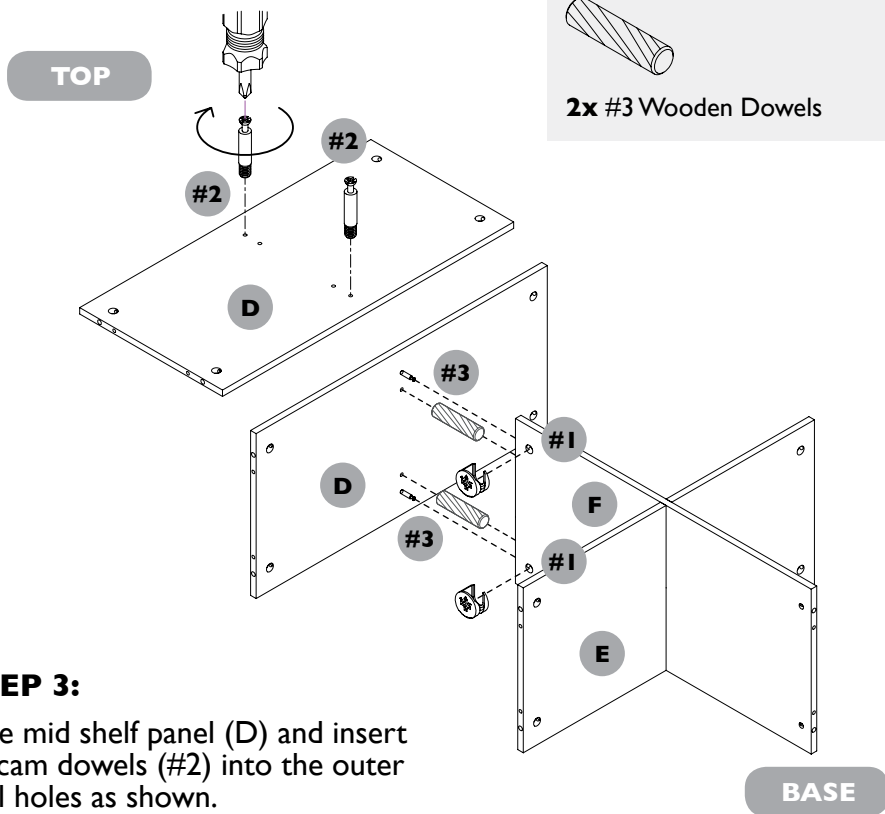

STEP 3:

Take mid shelf panel (D) and insert 2x cam dowels (#2) into the outer drill holes as shown.

Now insert 2x wooden dowels (#3) into the inner holes of the top of divider panel (F).

Position shelf panel (D) with the small drill holes on the long edge facing up and the large drill holes facing to the base.

Now connect panel D with panel F and when in place, insert 2x cam locks (#1) into the large drill holes on divider panel (F) and turn clockwise to secure.

Hardware for Step 4:



4x #3 Wooden Dowels



4x #1 Cam Locks

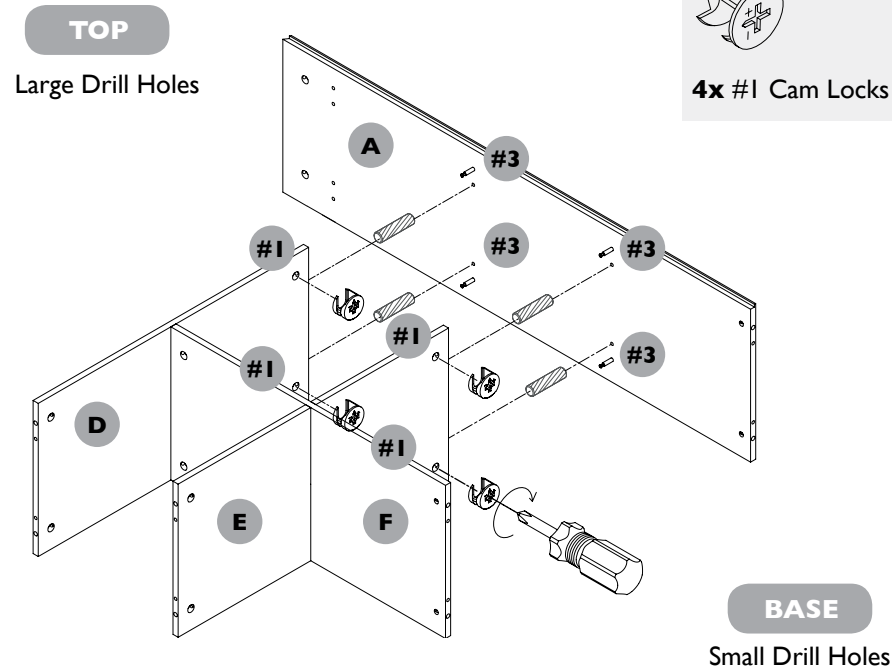

STEP 4:

Insert 2x wooden dowels (#3) into the inner holes on the RH end of BOTH panels D and E.

Take side panel (A) and position with the recessed long edge facing up.

Connect side panel (A) with the RH ends of panels D & E.

When in place, insert 2x cam locks (#1) into the large drill holes on the undersides of BOTH panels D & E and turn clockwise to secure and fix the panels together.

Hardware for Step 5:

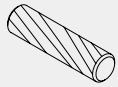

2x #3 Wooden Dowels



2x #1 Cam Locks

Hardware for Step 6:

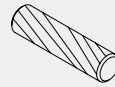

6x #3 Wooden Dowels



6x #1 Cam Locks

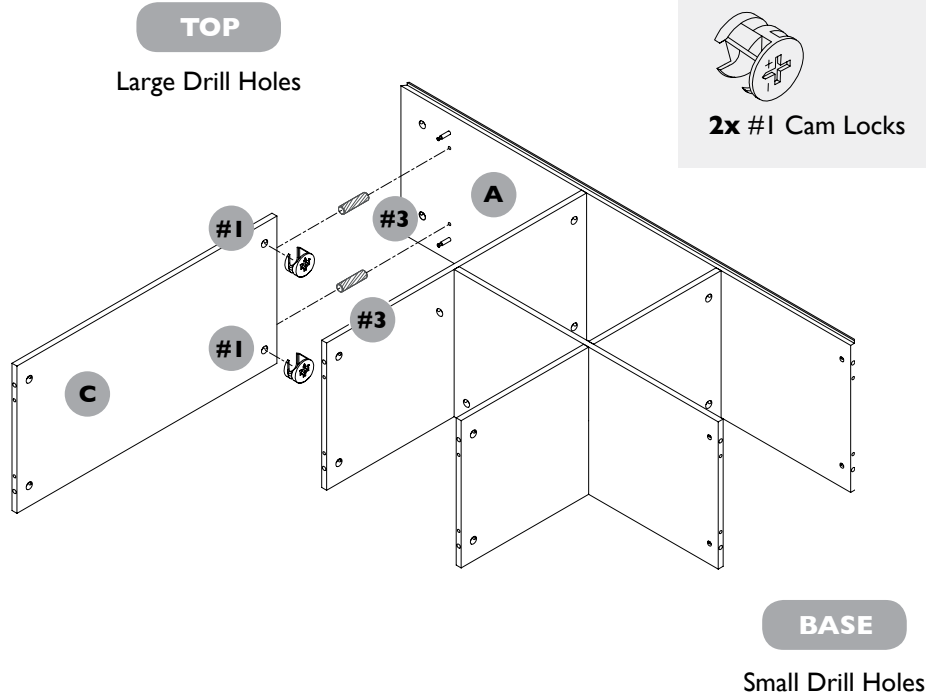

STEP 5:

Insert 2x wooden dowels (#3) into the holes next to the remaining cam dowel hardware on side panel (A).

Now take upper shelf panel (C) and position with the small drill holes along the long edge facing up and the large drill holes facing towards the shelf below.

Connect shelf panel (C) with side panel (A) and when in position insert 2x cam locks (#1) into the large holes on the underside of panel C.

Turn clockwise to lock and secure the join.

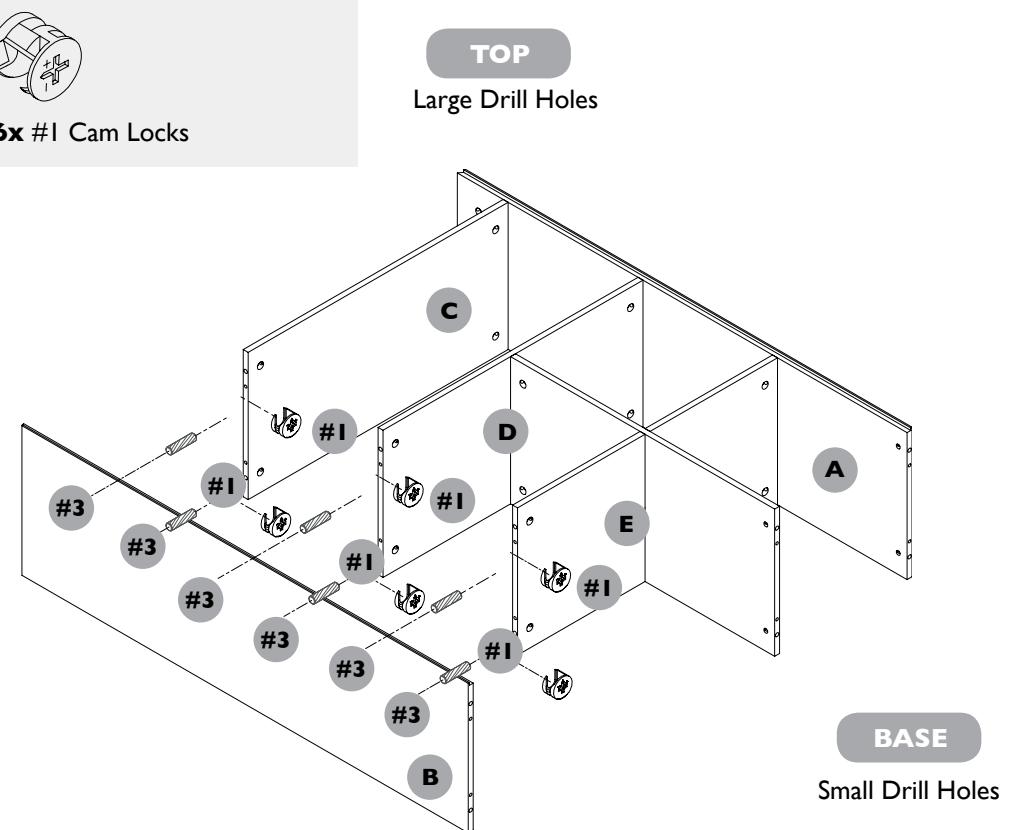

STEP 6:

Insert 2x wooden dowels (#3) into the inner holes of LH ends of panels C, D & E.

Take side panel (B) and position with the recessed long edge facing up.

Connect side panel (B) with the LH ends of panels C, D & E.

When in place, insert 2x cam locks (#1) into the large drill holes on the undersides of panels C, D & E and turn clockwise to secure and fix the panels together.

Hardware for Step 7:

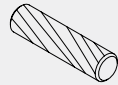

6x #3 Wooden Dowels



6x #8 Barrel Nuts



6x #7 Crosshead Bolts

TOP

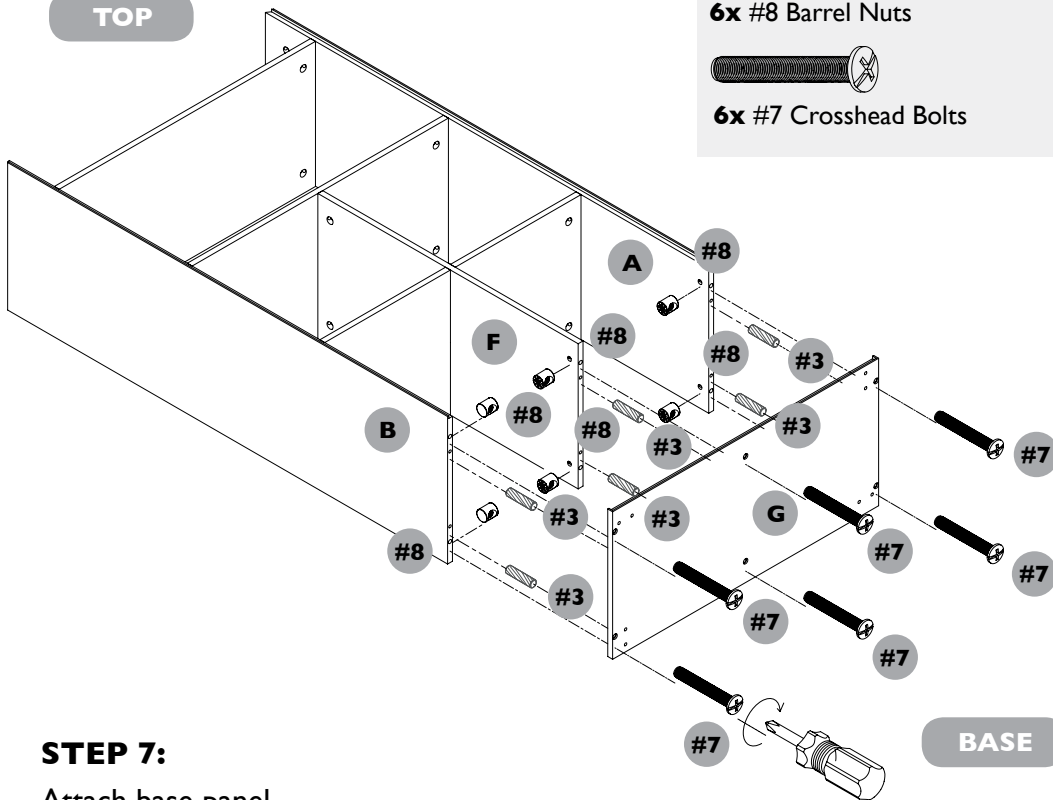

STEP 7:

Attach base panel.

Begin by inserting 6x wooden dowels (#3) into the inner holes on the ends of panels A, F & B.

Now insert 6x barrel nuts (#8) into the inside faces of panels A, F & B. Ensure that the hole of the barrel nut is facing towards the base and keep the end with the notches facing out (in case adjustment is needed).

Bring the base panel (G) to the unit with the recessed edge facing up and push into position.

Using your Philips screwdriver, insert 6x crosshead bolts (#7) into the larger holes at either side and the centre of the base. Fully tighten.

BASE

Hardware for Step 8:

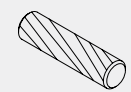

4x #3 Wooden Dowels



4x #7 Crosshead Bolts

TOP

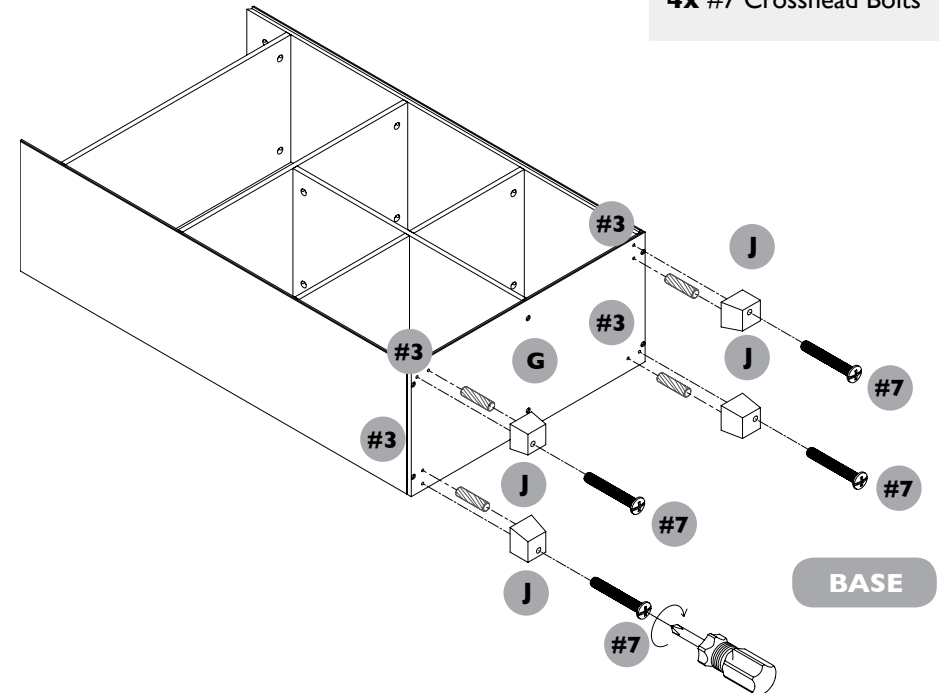

BASE

STEP 8:

Now attach the 4x feet (J) to the base panel (G).

Insert 4x wooden dowels (#3) into the inner hole of each hole set at the corners of panel G.

Apply a foot (J) to the first corner, using the wooden dowel to position it and then secure in place using 1x crosshead bolt (#7).

Ensure the hardware is fully tightened, but do not over-tighten or use power tools for this step or you risk driving the bolt through the base panel.

Repeat with 3 remaining feet.

Hardware for Step 9:



4x #4 Pivoting Cam Dowels

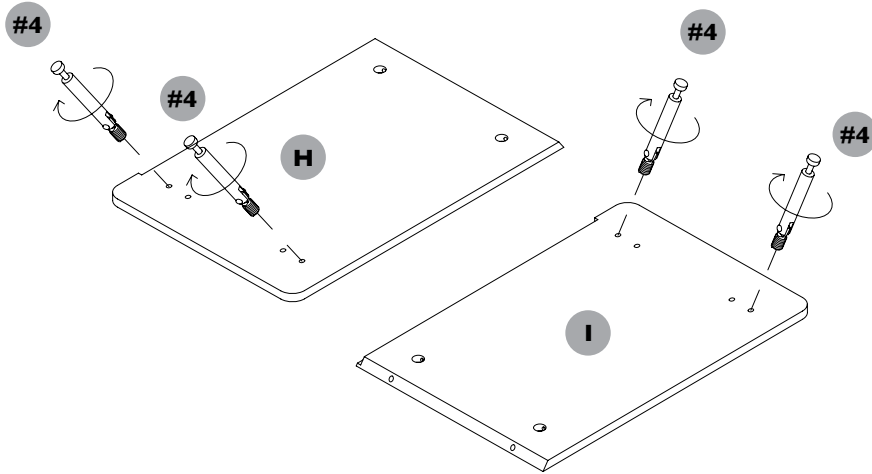

STEP 9:

Prepare the roof panels (H & I) by inserting 2x pivoting cam dowels (#4) into the outer small holes of BOTH panels as shown.

The holes are drilled at an angle and it is best to insert the hardware at the same angle as the hole.

The pivoting hardware is inserted using your fingers, not a tool.

Please ensure the thread on the cam dowel is fully inserted at the higher point of the hole.

When fully inserted, please ensure the line of pivoting is parallel with the longer sides of the roof panels.

Please take care as the hardware can mark the unit during insertion. However, please note that this will not show in the finished unit.

Note: Some cracking around the drill hole is normal as the bolt bites into the wood at an angle. This will be covered once the roof is attached to the main body of the bookcase.

Hardware for Step 10:

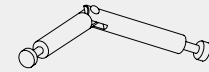

2x #5 Double ended Cam Dowel

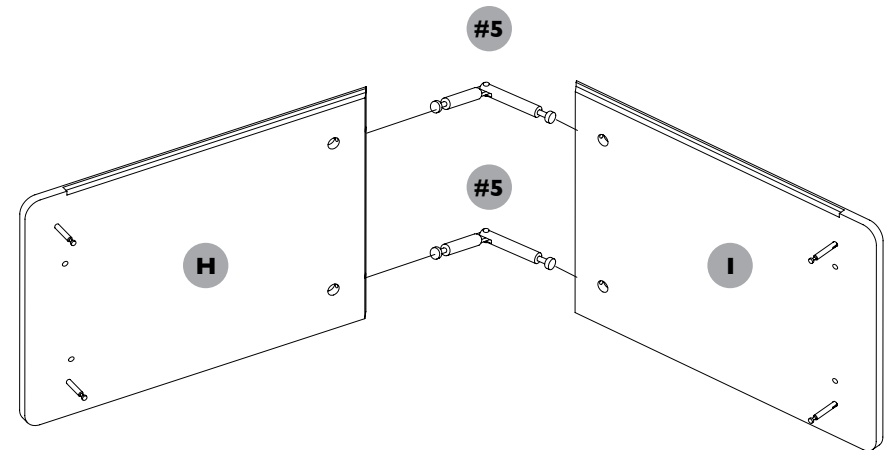

STEP 10:

Position the 2x roof panels (H & I) as shown with the recessed edges facing up.

Take the 2x double ended cam dowels (#5) and insert one end into one roof panel, then insert the other end into the other panel as you bring them together and connect them.

Hardware for Step 11:



4x #1 Cam Locks

Start

1st Position

Final Position

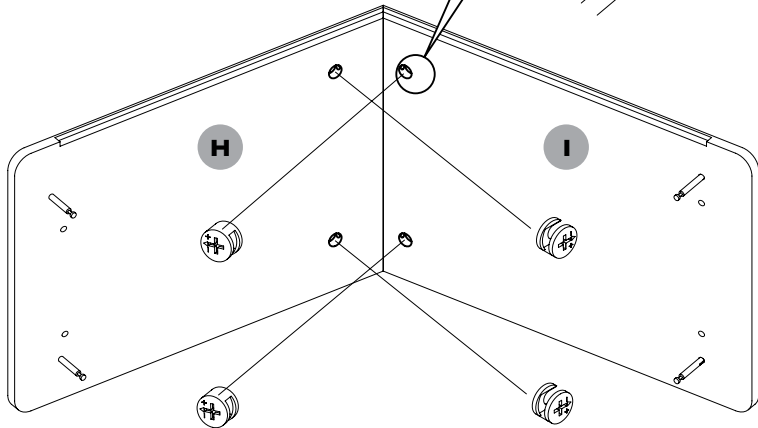
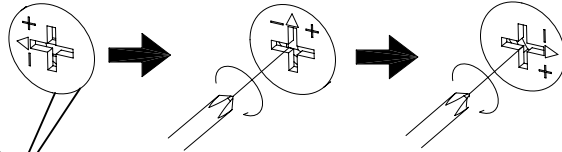

STEP 11:

To achieve the correct roof alignment, please follow this guidance. Do not tighten one side of the roof hardware fully first or it will not align.

Insert 4x cam locks (#1) into the large holes on the inside of the roof panels (H & I).

Start with the upper set and tighten one cam lock on your chosen side a quarter turn clockwise (first position).

Now tighten the opposite upper cam lock a quarter turn clockwise (to first position). Ensure that both have connected with the cam dowel hardware.

Now go to the lower set of cam locks and repeat the quarter turn on each side.

Check that the roof is aligned and then fully tighten all four cam locks (to final position).

Hardware for Step 12:



4x #3 Wooden Dowels



4x #1 Cam Locks

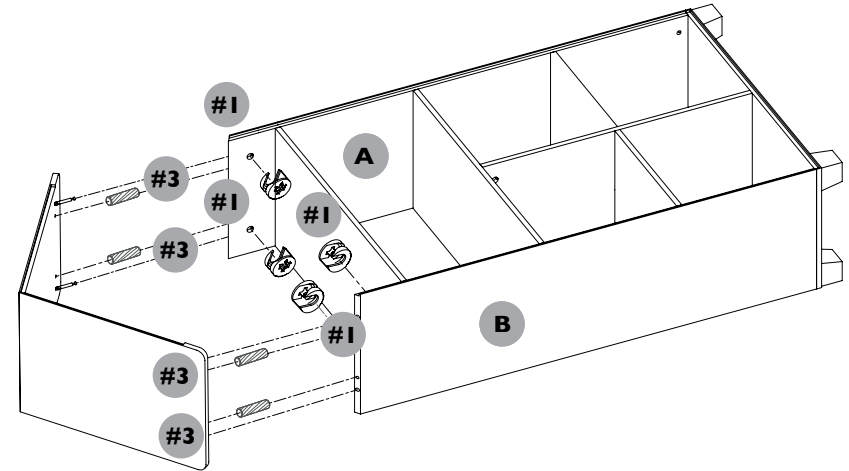

STEP 12:

Prepare to attach the roof by inserting 4x wooden dowels (#3) into the inner holes on the ends of both side panels (A & B).

Bring the completed roof (H & I) to the unit, keeping the recessed edges facing up. Open out the pivoting cam dowels so they can be received by the side panels and carefully push the roof into place using the wooden dowels to guide the positioning.

Once the roof is in place, insert 4x cam locks (#1) into the large drill holes on the side panels (A & B).

Again, as per step 11, turn each cam lock a quarter turn clockwise first to ensure the alignment is correct, then go back and fully tighten all four.

Note: If the roof is not quite aligned once attached to the bookcase, the cam locks at the roof pitch can be loosened, adjusted and re-tightened to correct the alignment.

Hardware for Step 13:

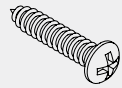

26x #6 Back Panel Screws

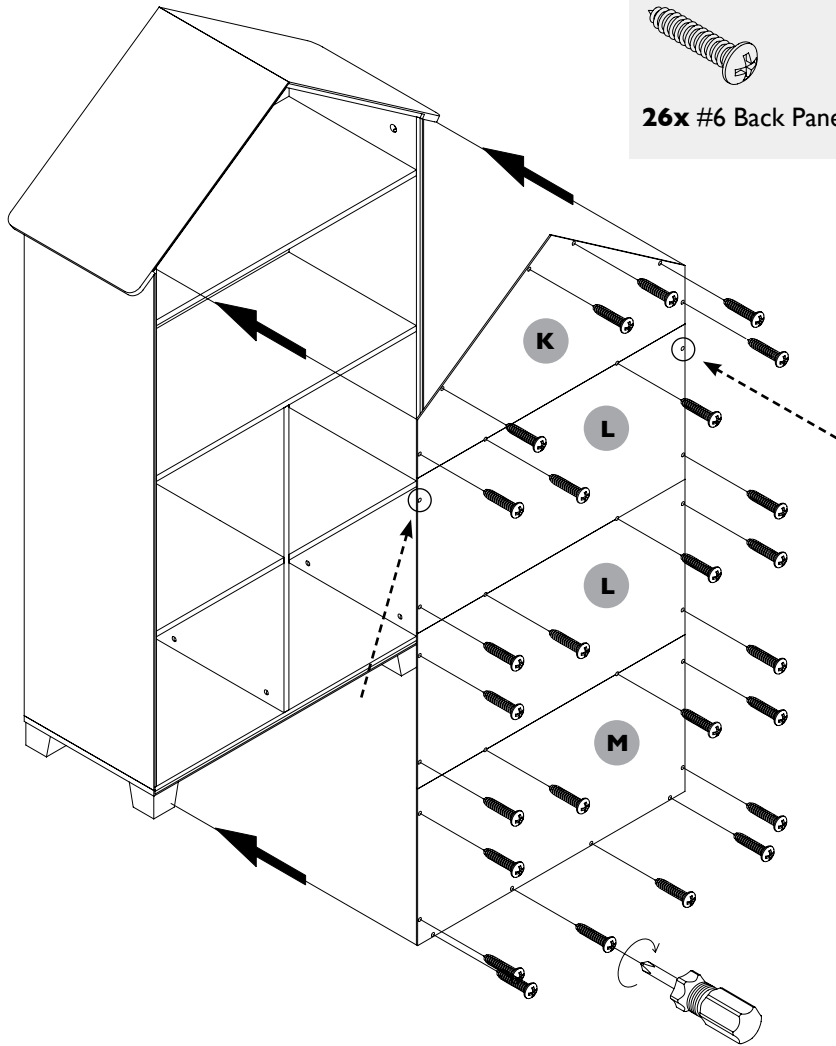

STEP 13:

Keeping the unit on the floor for the moment, position the 4x back panels (K, 2xL & M) into the recessed edges of the unit as shown. Ensure the drill holes on the panels are aligned with the pilot holes on the unit and that the panels are in the correct positions.

Insert 26x back panel screws (#6) into the holes shown - please note there are 2 holes highlighted that need to be left for for anti-tip kit applied in step 14.

STEP 14:

Carefully stand the unit on its feet with the help of a second person if necessary.

Apply 2x brackets and 2x screws from the anti-tip kit (#9) to complete the attachment of the back panels.

It is important and recommended that you use the anti-tip kit provided to prevent any furniture tipping accidents.

Attach the 2nd set of brackets to the wall using hardware that is suitable for the walls in your home (not supplied).

Your unit is now ready to use.

Hardware for Step 14:



1x Anti Tip Kit

