

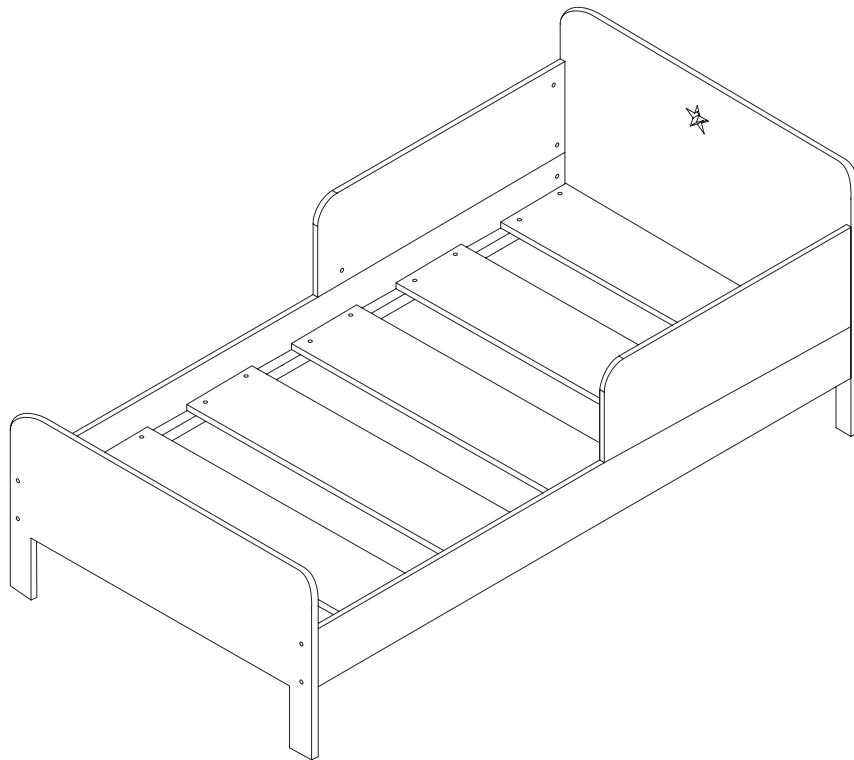

www.gltc.co.uk

Star Bright Toddler Bed

L4944



Assembly Difficulty



easy - medium - hard



two-person job



10/12/2019

Thank you for shopping with GLTC, we hope you enjoy having this product in your home.

We know assembling furniture, toys or accessories is not everyone's favourite way to spend their time, so we've tried to make assembling this item as quick and painless as possible.

Hopefully our efforts will have been worthwhile and you'll sail through the whole process. But if it all feels a bit too much like hard work, then we do have an assembly company we can recommend: the Flatpack Construction Company offers a nationwide service and can be contacted on **0843 289 4951** or **www.flatpackconstruction.co.uk**.

A few important pointers before you start:

- Please read the instructions right through before you start, and check that all the components have been included in the pack; we find separating all the hardware into piles makes it easier to be sure that everything is present and correct.
- Make sure you have the right tools. Allen keys are provided if required, but screw drivers and other tools are not. You'll find details of the tools you need at the beginning of the instructions.
- It's a good idea to build the unit in the room where you are going to be using it, to avoid the need to move it after it's been assembled.
- Do not throw away any packing materials until assembly is complete, just in case you accidentally discard smaller parts or hardware.

IMPORTANT READ CAREFULLY - KEEP FOR FUTURE REFERENCE.

Safety Warnings:

- Toddler bed: This bed conforms to BS 8509:2008+A1:2011
- Suitable for children from 18 months to 4 years old.
- This bed is suitable for use with mattress size: 140cmL x 70cmW x 10cmD
- This bed is tested to a maximum weight load of 16 stone/ 106 KG.
- CAUTION Adult assembly required.
- In an unassembled state product contains small parts which may pose a choking hazard, not suitable for children under 3 years.
- Assembly to be carried out by a competent adult only. During assembly children should be kept away from the product due to possible risk of injury. Do not use this item if any components are missing or damaged.
- DO NOT use power tools in the assembly of this product as there is a risk of over-tightening and consequently splitting of the wood.
- Assemble and use on a flat and level surface
- This product is heavy. We recommend that you build it where you are planning to use it.
- Do not place this child's bed near heat sources, windows and other furniture.
- Children are likely to play, bounce, jump and climb on beds, therefore

the child's bed should not be placed too close to other furniture, windows, blind cords, curtain pulls or other strings and cords.

- Do not use this child's bed if any part is broken, torn or missing. Use only spare parts approved and supplied by the manufacturer.
- For your child's safety, this bed should be placed either tight to any wall or have a gap of 300mm between the wall and the side of the bed.
- Dismantle this bed if required to be placed in long term storage or for transportation.
- Regularly check all fixtures and fittings and tighten as necessary.

Customer Service:

- If you find that any components are missing or damaged, please do not begin assembly and do not use the item. Please contact GLTC Customer Services on **0344 848 6000** immediately.

Product Care and Information:

- Wipe clean using a soft damp cloth followed by a dry cloth.
- Do NOT use cleaning products which contain ammonia, solvents or abrasive material.
- Do NOT expose the item to extremes of heat and humidity.
- Please ensure the room in which this bed is to be used is well ventilated or aired regularly in order to keep humidity low in and around the bed.
- Made in China.

Could we do better?

If there is anything you think could be improved in these instructions or in the assembly of this product we'd be grateful if you could let us know; we'll pass any helpful hints and tips on to other customers via our website and update the instructions.





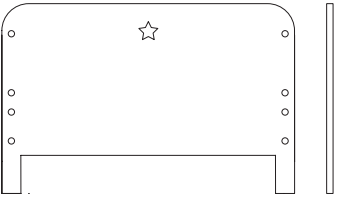
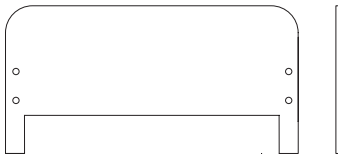
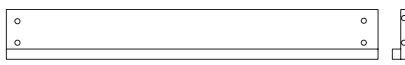
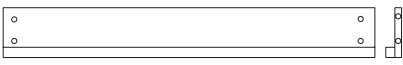
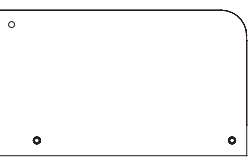
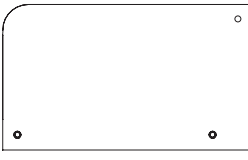
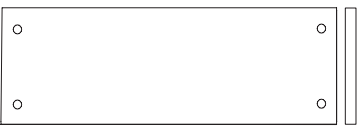

All you need to do is drop us a line at instructions@gltc.co.uk

Thank you

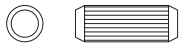
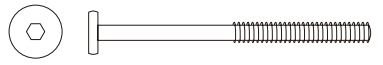
Component Check List

<p>A</p>  <p>1x Headboard</p>	<p>B</p>  <p>1x Footboard</p>
<p>C</p>  <p>1x Side Rail</p>	<p>D</p>  <p>1x Side Rail</p>
<p>E</p>  <p>1x Guard Rail</p>	<p>F</p>  <p>1x Guard Rail</p>
<p>G</p>  <p>5x Slats</p>	

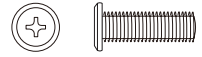
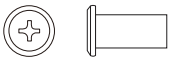
Component Check List

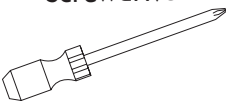
<p>#1</p>  <p>6x Wooden Dowel</p>	<p>#2</p>  <p>4x Hex Bolt (122mm)</p>
<p>#3</p>  <p>4x Barrel Nut (Silver)</p>	<p>#4</p>  <p>10x Hex Bolt (66mm)</p>
<p>#5</p>  <p>10x Barrel Nut</p>	<p>#6</p>  <p>20x Slat Bolt (35mm)</p>
<p>#7</p>  <p>20x Slat Top Hat Nut</p>	 <p>1x Allen Key</p>
<p>Your will need a Phillips Screwdriver  (not supplied)</p>	

STEP 1:

Attach the guard rails to the side rails.

Position the side rails (C&D) as shown - the holes on each of the side rail edges should be at the same end.

Insert 2x wooden dowels (#1) into the inner holes on side rail panel D and position the guard rail panel E onto the side rail.

Insert 2x barrel nuts (#3) into the holes on the guard rail then insert 2x long bolts (#2) through the side rail from the underside and into the barrel nuts. Fully tighten using the Allen key.

Repeat for panels C & F.

Hardware for Step 1:



4x #1 Wooden dowel

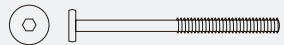

4x #2 Hex Bolt (122mm)

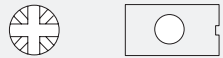

4x #3 Barrel Nut (Silver)

NOTE:

Make sure these holes are on the top edge of the side rail are the headboard end.

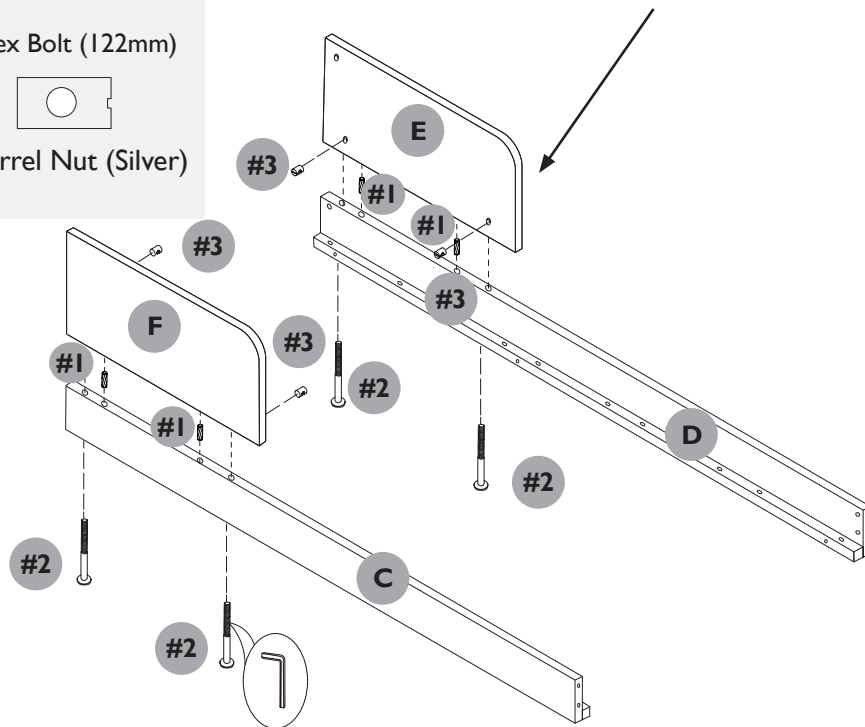

STEP 2:

Insert 1x wooden dowel (#1) into the lower hole of the guard rail (E).

Insert 3x barrel nuts (#5) into the remaining holes of the side rail (D) and guard rail (E).

Join headboard (A) to the side/guard rail then insert 3x hex bolts (#4) to secure. Fully tighten the hardware with the Allen key provided.

Repeat with panels F & C.

Insert 2x Barrel nut (#5) into the ends of BOTH side rails (C&D). With the aid of a second person lifting both of the side rail ends, fix the footboard (B) in place with 2x Hex bolt (#4) on both sides of the bed.

Ensure all bolts are fully tightened.

Hardware for Step 2:

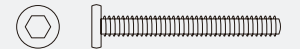

10x #4 Hex Bolt (66mm)



10x #5 Barrel Nut



4x #1 Wooden dowel



1x Allen key

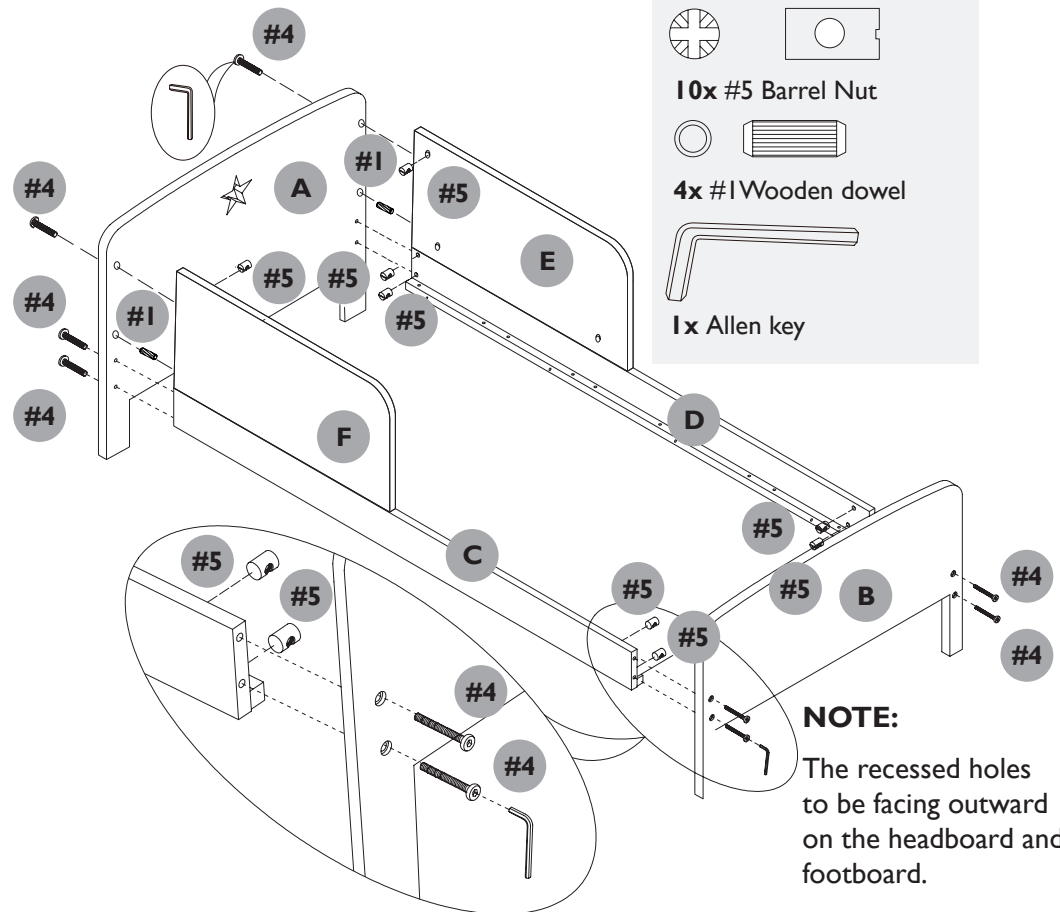

NOTE:

The recessed holes to be facing outward on the headboard and footboard.

STEP 3:

Lay the slats (G) in place and align with the drill holes on the slat support rails.
Fix EACH slat in place with 4x Bolt (#6) & 4x Top Hat Nut (#7).

Hardware for Step 3:



20x #6 Slat Bolt



20x #7 Slat Top Hat Nut

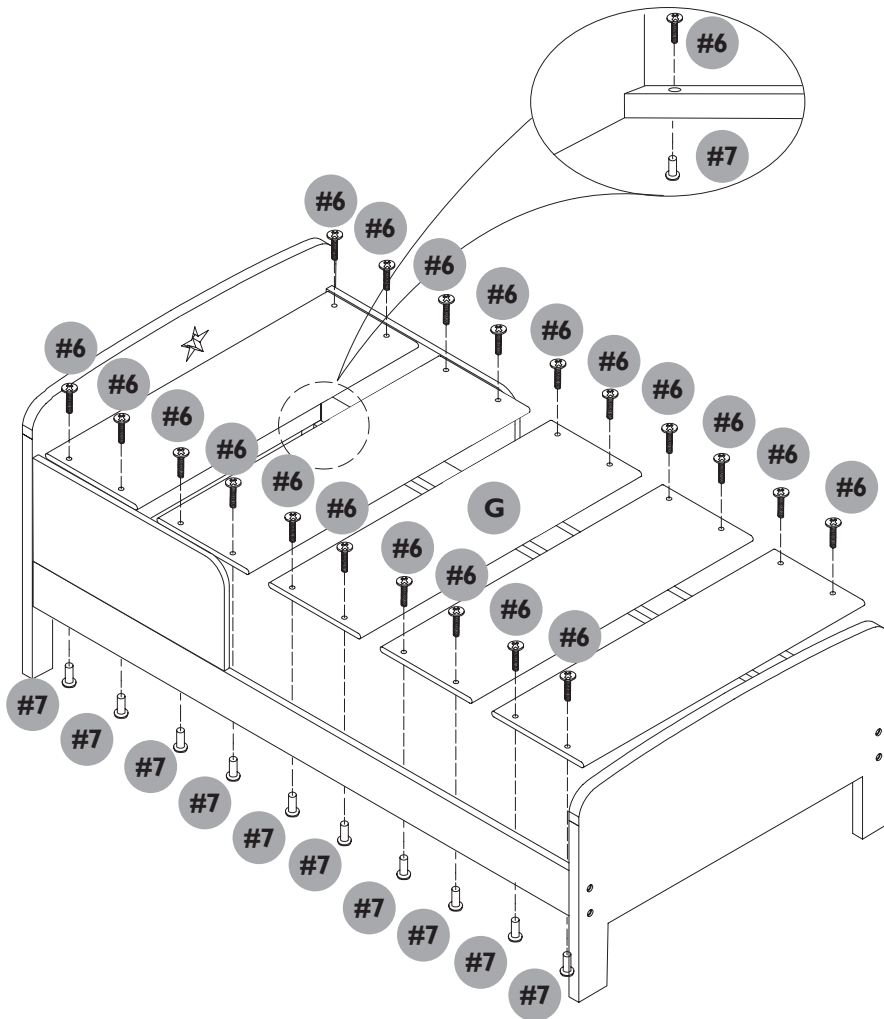

The toddler bed is now ready to use.

Please use a 140 x 70cm x 10cm mattress is used with this bed.

