

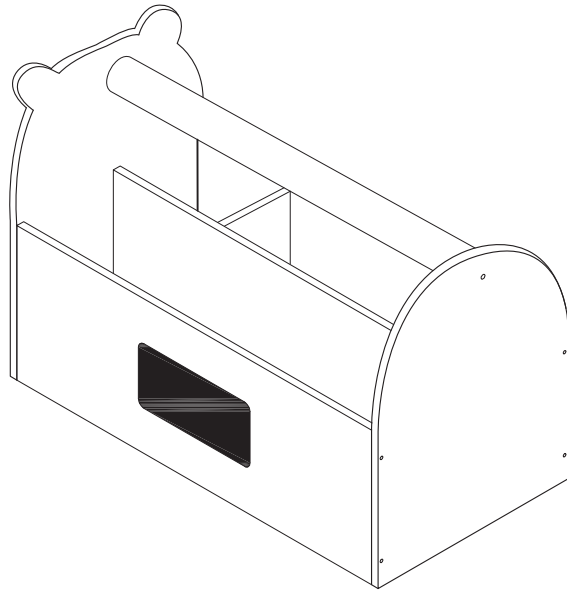

gltc.co.uk

Carry Caddy



Assembly Difficulty



easy - medium - hard



one-person job



28/05/2019

Thank you for shopping with GLTC, we hope you enjoy having this product in your home.

We know assembling furniture, toys or accessories is not everyone's favourite way to spend their time, so we've tried to make assembling this item as quick and painless as possible.

Hopefully our efforts will have been worthwhile and you'll sail through the whole process. But if it all feels a bit too much like hard work, then we do have an assembly company we can recommend: the Flatpack Construction Company offers a nationwide service and can be contacted on **0843 289 4951** or **www.flatpackconstruction.co.uk**.

A few important pointers before you start:

- Please read the instructions right through before you start, and check that all the components have been included in the pack; we find separating all the hardware into piles makes it easier to be sure that everything is present and correct.
- Make sure you have the right tools. Allen keys are provided if required, but screw drivers and other tools are not. You'll find details of the tools you need at the beginning of the instructions.
- It's a good idea to build the unit in the room where you are going to be using it, to avoid the need to move it after it's been assembled.
- Do not throw away any packing materials until assembly is complete, just in case you accidentally discard smaller parts or hardware.

WARNINGS!:

- **WARNING!** Not suitable for children under 3 years due to small parts which may become detached and present a choking hazard.
- **CAUTION** Adult assembly required.
- In an unassembled state product contains small parts which may pose a choking hazard, not suitable for children under 3 years.
- Assembly to be carried out by a competent adult only. During assembly children should be kept away from the product due to possible risk of injury. Do not use this item if any components are missing or damaged.
- **DO NOT** use power tools in the assembly of this product as there is a risk of over-tightening and consequently splitting of the wood
- Wipe clean only.
- Regularly check all fastenings, fixtures and fittings to ensure that they are properly tightened.
- Remove all packaging before giving to your child.
- Colour and specification may vary.
- Made in China.
- Please retain this information for future reference.



Customer Service:

- If you find that any components are missing or damaged, please do not begin assembly and do not use the item. Please contact GLTC Customer Services on **0344 848 6000** immediately.
- We do stock spare hardware packs at our warehouse, so we should be able to send you a replacement pack immediately if required.

Product Care:

- Wipe clean using a soft damp cloth followed by a dry cloth.
- **Do NOT** use cleaning products which contain ammonia, solvents or abrasive material.
- **Do NOT** expose the item to extremes of heat and humidity.

Could we do better?

If there is anything you think could be improved in these instructions or in the assembly of this product we'd be grateful if you could let us know; we'll pass any helpful hints and tips on to other customers via our website and update the instructions.

All you need to do is drop us a line at instructions@gltc.co.uk

Thank you

Component Check List

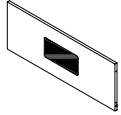
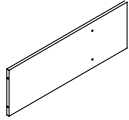
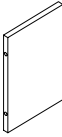
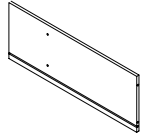
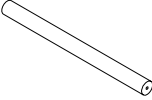
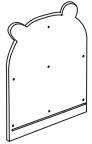
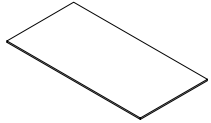
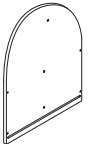
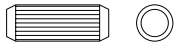
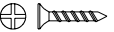
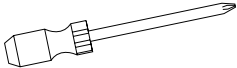
<p>A</p>  <p>1x Front Panel</p>	<p>B</p>  <p>1x Middle Divider Panel</p>
<p>C</p>  <p>1x Short Divider Panel</p>	<p>D</p>  <p>1x Back Panel</p>
<p>E</p>  <p>1x Handle</p>	<p>F</p>  <p>1x Left Side Panel</p>
<p>G</p>  <p>1x Base Panel</p>	<p>H</p>  <p>1x Right Side Panel</p>
<p>#1</p>  <p>8x Wooden Dowels 20mmL</p>	<p>#1</p>  <p>10x Screws 22mmL</p>
<p>You will need (not supplied)</p>  <p>Phillips Head Screwdriver</p>	

Hardware for Step 1:



4x #1 wooden dowels

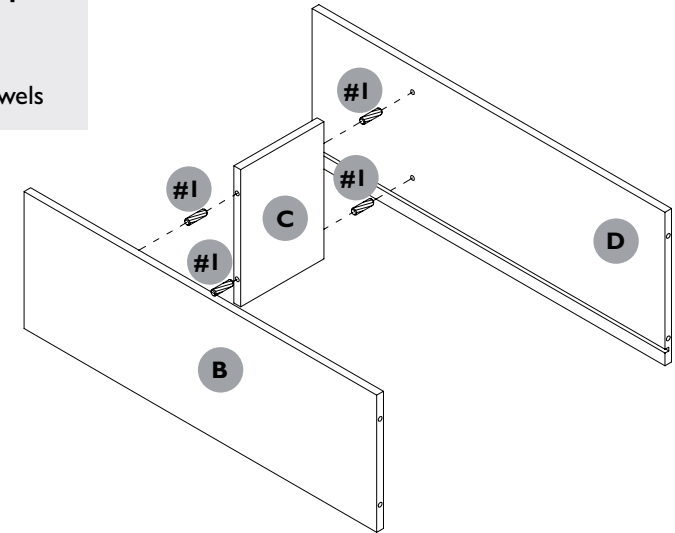

STEP 1:

Insert 4x wooden dowels (#1) into short divider panel (C). Now push middle divider panel (B) and back panel (D) into the short divider panel (C) using the dowels.

Hardware for Step 2:



2x #1 wooden dowels



5x #2 22mmL screws

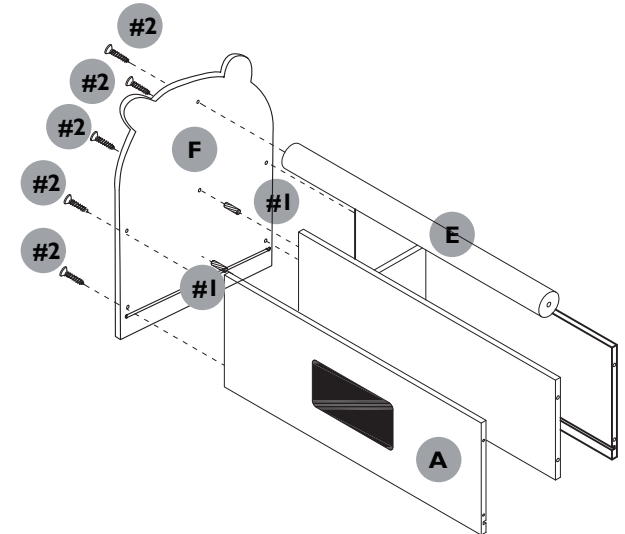

STEP 2:

Attach left side panel (F) to the assembly created in step 1, front panel (A) and handle (E) using 2x wooden dowels (#1) and 5x screws (#2).

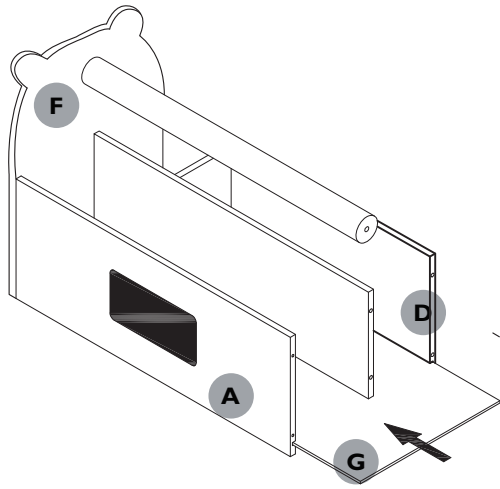

STEP 3:

Carefully slide base panel (G) along the grooves located on the internal faces of panels A, D and F.

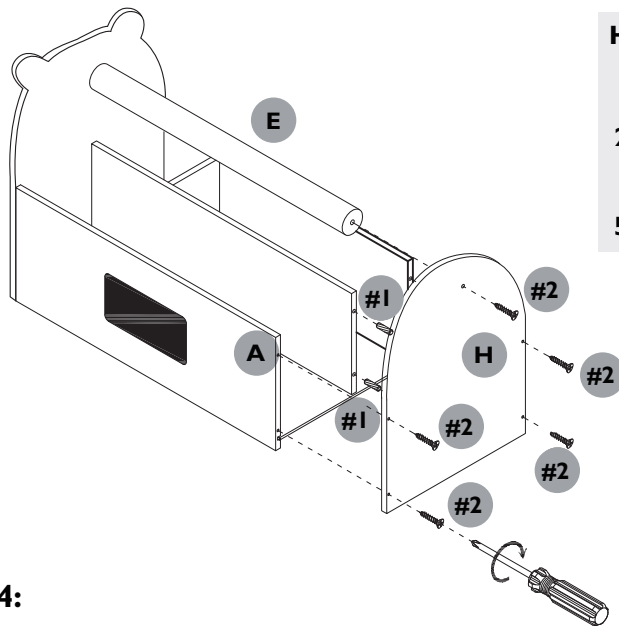

Hardware for Step 4:



2x #1 wooden dowels



5x #2 22mmL screws

STEP 4:

Attach right side panel (H) to the assembly created in step 3, using 2x wooden dowels (#1) and 5x screws (#2).

The assembly is now complete.

