

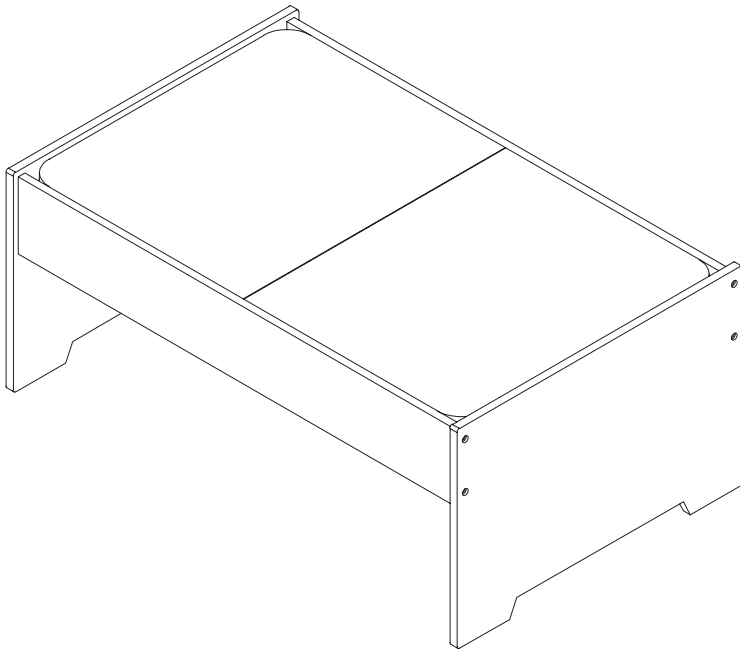

gltc.co.uk

Bodmin Playtable L4772



Assembly Difficulty



easy - medium - hard



one-person job

V2

29/05/2020

Thank you for shopping with GLTC, we hope you enjoy having this product in your home.

We know assembling furniture, toys or accessories is not everyone's favourite way to spend their time, so we've tried to make assembling this item as quick and painless as possible.

Hopefully our efforts will have been worthwhile and you'll sail through the whole process. But if it all feels a bit too much like hard work, then we do have an assembly company we can recommend: the Flatpack Construction Company offers a nationwide service and can be contacted on **0843 289 4951** or **www.flatpackconstruction.co.uk**.

A few important pointers before you start:

- Please read the instructions right through before you start, and check that all the components have been included in the pack; we find separating all the hardware into piles makes it easier to be sure that everything is present and correct.
- Make sure you have the right tools. Allen keys are provided if required, but screw drivers and other tools are not. You'll find details of the tools you need at the beginning of the instructions.
- Do not throw away any packing materials until assembly is complete, just in case you accidentally discard smaller parts or hardware.

Safety Warnings:

- Please read these instructions carefully before assembly.
- Adult assembly required.
- Unassembled product contains small parts which may present a choking hazard.
- Not suitable for children under 3 years due to small parts that may become detached and present a choking hazard.
- Children should be kept away from the product during assembly to avoid any possible risk of injury.
- Assemble and use on a flat and level surface.
- Adult assistance will be required to change over the table top.
- To avoid possible injury from tipping - DO NOT allow children to sit, step or climb on the product.
- DO NOT use power tools in the assembly of this product as there is a risk of over-tightening and consequently splitting of the wood.
- Check item regularly for signs of damage which may make the product unsafe.
- Check all fixtures and fittings regularly and tighten as necessary.
- DO NOT use this item if any components are missing or damaged.
- Please retain these instructions for future reference.

Customer Service:

- If you find that any components are missing or damaged, please do not begin assembly and do not use the item. Please contact GLTC Customer Services on **0344 848 6000** immediately.
- We do stock spare hardware packs at our warehouse, so we should be able to send you a replacement pack immediately if required.

Product Care:

- Wipe clean using a soft damp cloth followed by a dry cloth.
- Do NOT use cleaning products which contain ammonia, solvents or abrasive material.
- Do NOT expose the item to extremes of heat and humidity.

Could we do better?





If there is anything you think could be improved in these instructions or in the assembly of this product we'd be grateful if you could let us know; we'll pass any helpful hints and tips on to other customers via our website and update the instructions.

All you need to do is drop us a line at [**instructions@gltc.co.uk**](mailto:instructions@gltc.co.uk)

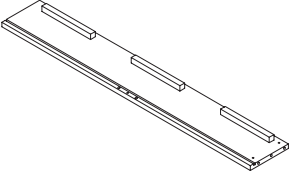
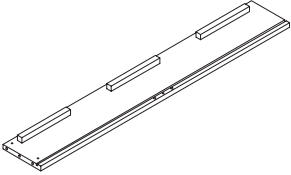
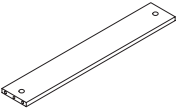
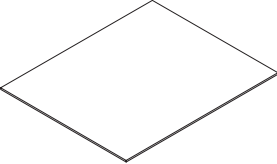
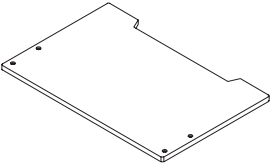
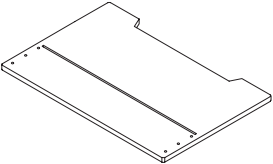
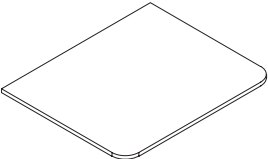
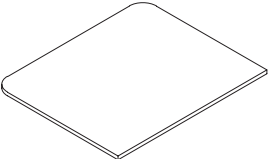
Thank you

Component Check List

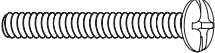
<p>A</p>  <p>1x LH Side Rail</p>	<p>B</p>  <p>1x RH Side Rail</p>
<p>C</p>  <p>1x Base Support Bar</p>	<p>D</p>  <p>2x Base Panels</p>
<p>E</p>  <p>1x LH End Panel</p>	<p>F</p>  <p>1x RH End Panel</p>
<p>G</p>  <p>1x RH Play Surface Panel</p>	<p>H</p>  <p>1x LH Play Surface Panel</p>

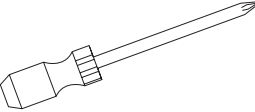
<p>#1</p>  <p>2x Cam Dowels 35mmL</p>	<p>#2</p>  <p>8x Wooden Dowels 25mmL</p>
<p>#3</p>  <p>2x Cam Locks 15mm dia</p>	<p>#4</p>  <p>8x Bolts 40mmL</p>
<p>#5</p>  <p>8x Barrel Nuts 10mm dia</p>	<p>#6</p> <p>You will need (not supplied)</p>  <p>Phillips Head Screwdriver</p>

Hardware for Step 1:

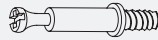

2x #1 Cam Dowels

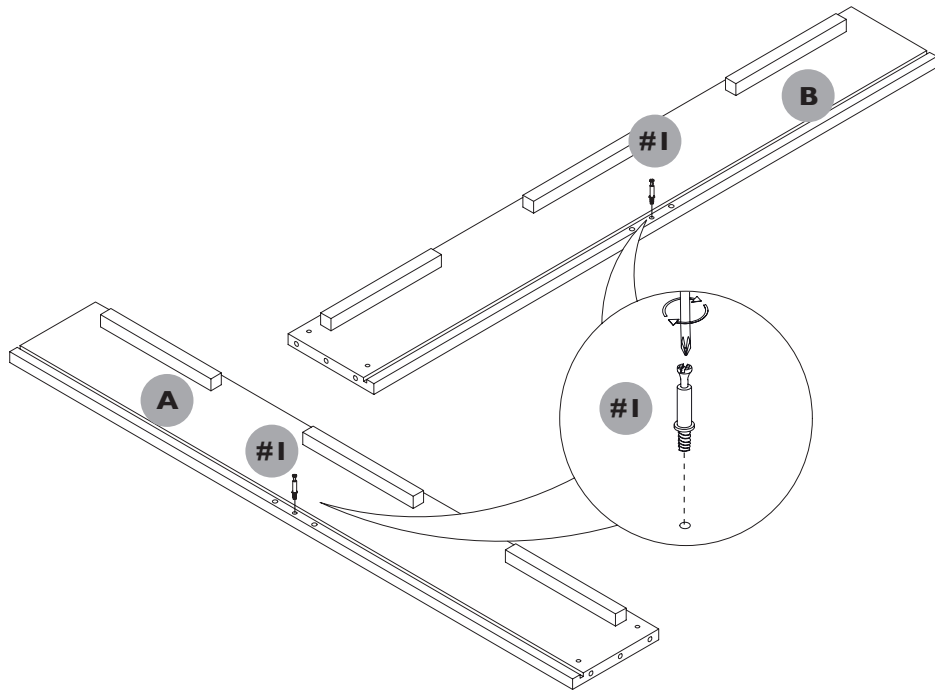

STEP 1:

Using a Phillips Screwdriver, insert 1x cam dowel (#1) into the central hole on BOTH side rail panels A & B.

Hardware for Step 2:



4x #2 Wooden Dowels



2x #3 Cam Locks

Using Cam Locks:

When inserting into the panel, ensure that each cam lock's arrow is pointing towards the drill hole on the side edge of the panel & the dowel that it will be receiving.

When the panels are in the connected position, using a screwdriver, turn the cam lock in a clockwise direction to lock and secure.

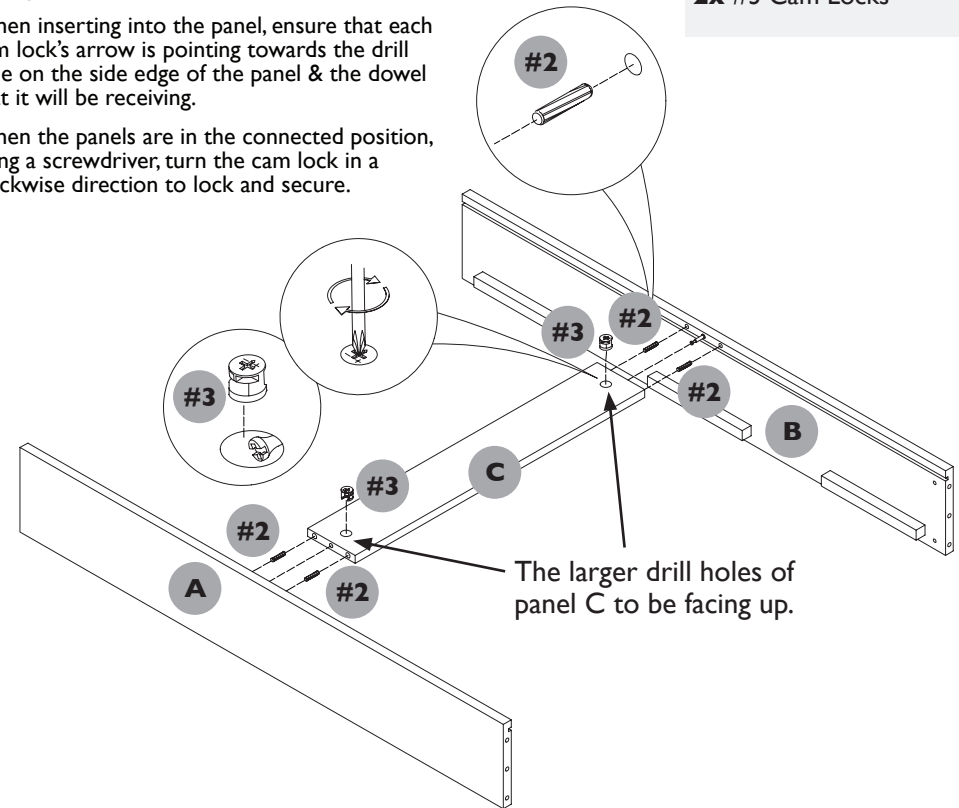

STEP 2:

Take panel B and insert 2x wooden dowels (#2) in the remaining central holes and then push support base panel C onto the hardware.

Insert 1x cam lock into the large drill hole on panel C at the connection point and turn clockwise to lock.

Repeat this step at the other end of panel C, joining it to panel A.

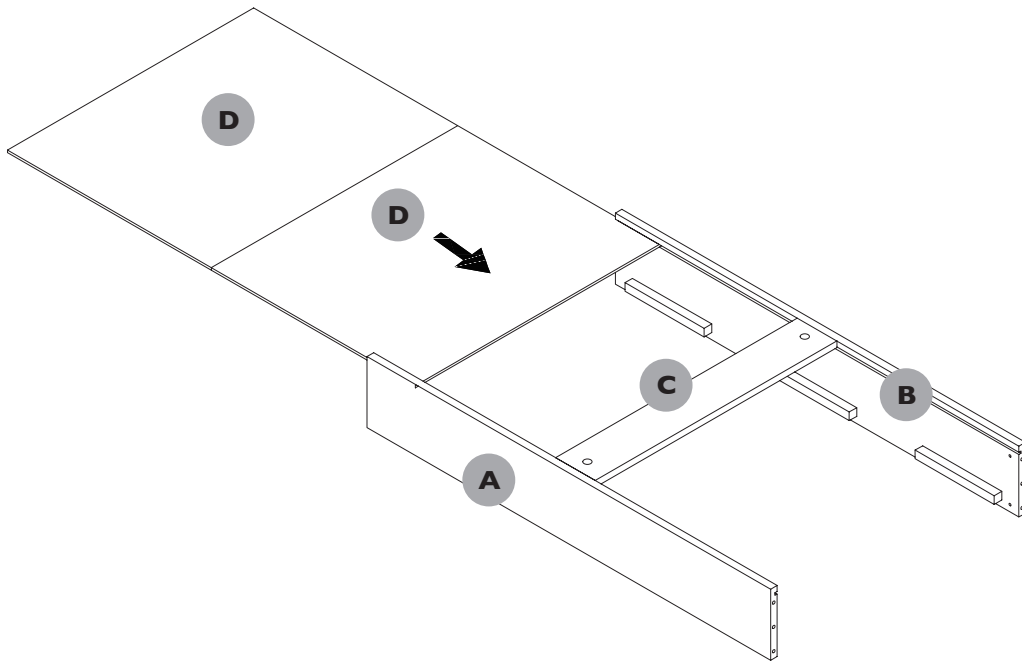

STEP 3:

Slide both base panels (D) into the groove of the side panels. It may be easier to slide each panel in from different ends.

STEP 4:

Carefully, turn the unit on its side,

Take both end panels E & F and insert 1x wooden dowel into the central drill hole on BOTH sides of EACH panel.

Take panel E and push into position on the ends of the side rails (A & B), lining up the groove with the base board.

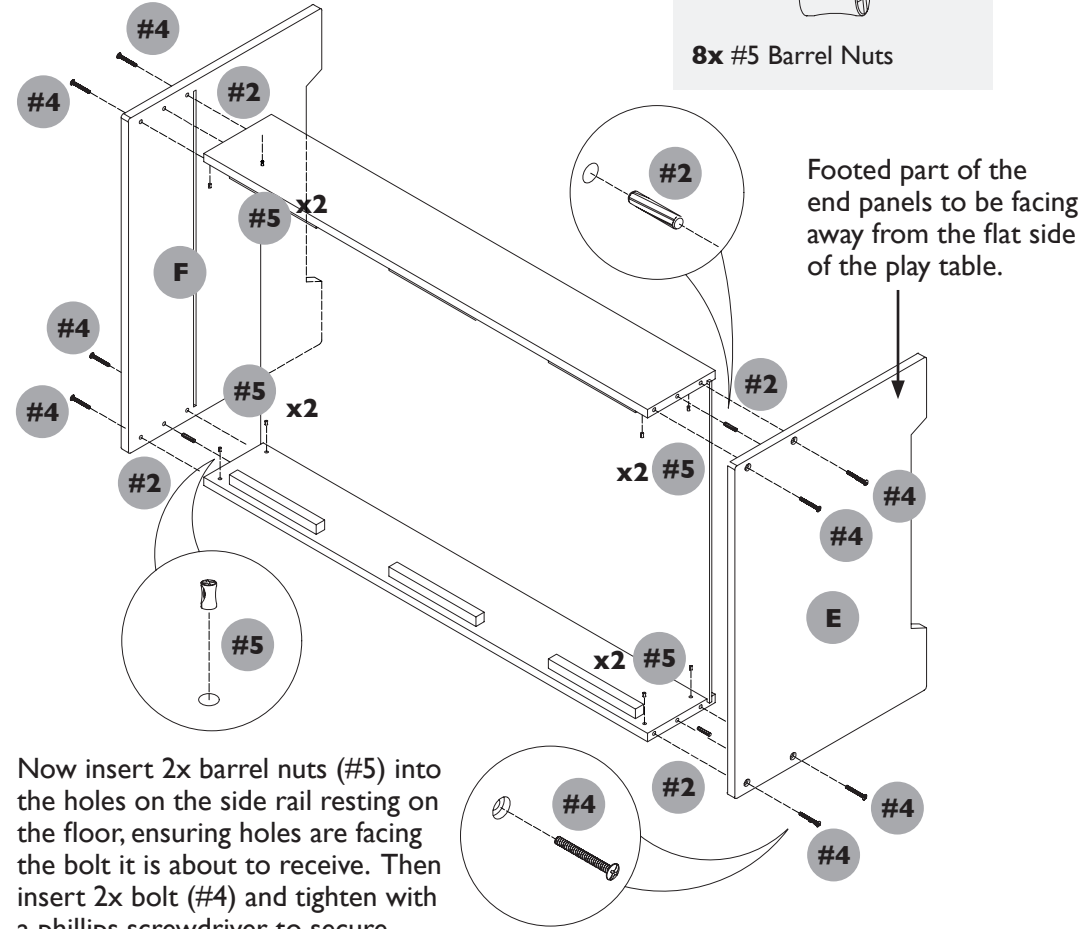

Hardware for Step 4:



4x #2 Wooden Dowels



8x #4 Bolts



8x #5 Barrel Nuts

Now insert 2x barrel nuts (#5) into the holes on the side rail resting on the floor, ensuring holes are facing the bolt it is about to receive. Then insert 2x bolt (#4) and tighten with a phillips screwdriver to secure.

Now insert the barrel nuts (#5) and bolts (#4) for the elevated side rail. You will have to do these one at a time, holding the barrel nut in place whilst you secure the bolt.

Repeat this step with panel F.

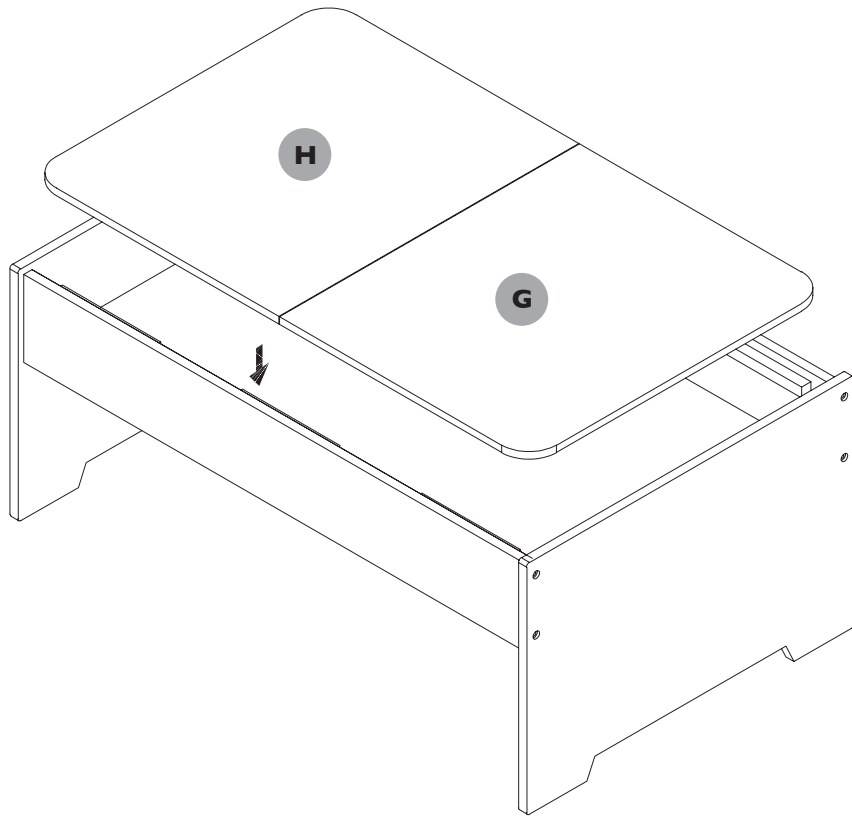

STEP 5:

Once all the bolts on the end panels are fully secure, carefully turn the play table over and insert the play surface panels G & H.

Your unit is now complete.

