

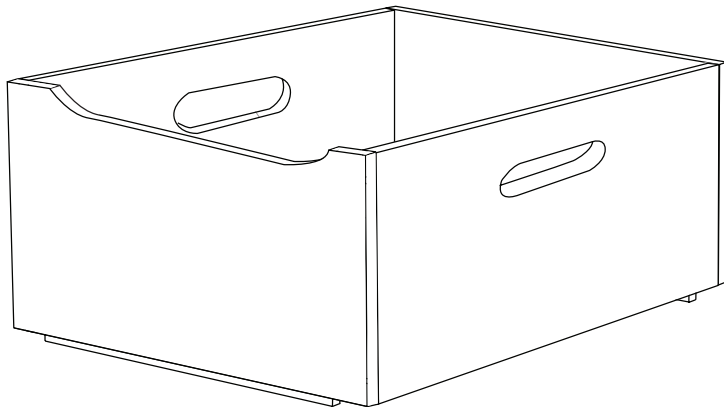

gltc.co.uk

Barbican Storage Tray, Grey L4655



Assembly Difficulty



easy - medium - hard



one-person job

V3

29/10/2018

Thank you for shopping with GLTC, we hope you enjoy having this product in your home.

We know assembling furniture, toys or accessories is not everyone's favourite way to spend their time, so we've tried to make assembling this item as quick and painless as possible.

Hopefully our efforts will have been worthwhile and you'll sail through the whole process. But if it all feels a bit too much like hard work, then we do have an assembly company we can recommend: the Flatpack Construction Company offers a nationwide service and can be contacted on **0843 289 4951** or **www.flatpackconstruction.co.uk**.

Good luck!

A few important pointers before you start:

- It might be worth checking on our website that there are no updates or revisions to these instructions (if we have had helpful feedback from other customers we pass it on via the product web page). Simply check the date and version number on the front of this leaflet against that of any site updates.
- Please read the instructions right through before you start, and check that all the components have been included in the pack; we find separating all the hardware into piles makes it easier to be sure that everything is present and correct.
- Make sure you have the right tools. Allen keys are provided if required, but screw drivers and other tools are not. You'll find details of the tools you need at the beginning of the instructions.
- It's a good idea to build the unit in the room where you are going to be using it, to avoid the need to move it after it's been assembled.
- Do not throw away any packing materials until assembly is complete, just in case you accidentally discard smaller parts or hardware.

Safety Warnings:

- **WARNING!** This is not a toy.
- Adult assembly required.
- Children should be kept away from the product during assembly to avoid any possible risk of injury.
- Unassembled product contains small parts which may present a choking hazard.
- Assemble and use on a flat and level surface.
- To avoid possible injury from tipping - Do not allow children to climb on this or multiple stacked units.
- We recommend that the storage boxes are stacked in pairs only, with the addition of a matching Stacking Storage Tray.
- Maximum weight load 5kg per box and tray for the standard size 32W x 31D x 27H(cm) and 9kg per box and tray for the large size 40W x 40D x 40H(cm). Do not overload.
- Check fixtures and fittings regularly and tighten as necessary.
- Please retain these instructions for future reference.

Customer Service:

- If you find that any components are missing or damaged, please do not begin assembly and do not use the item. Please contact GLTC Customer Services on **0344 848 6000** immediately.
- We do stock spare hardware packs at our warehouse, so we should be able to send you a replacement pack immediately if required.

Product Care:

- Wipe clean only.
- Do NOT use cleaning products which contain ammonia, solvents or abrasive material.
- Do NOT expose the item to extremes of heat and humidity.







Could we do better?

If there is anything you think could be improved in these instructions or in the assembly of this product we'd be grateful if you could let us know; we'll pass any helpful hints and tips on to other customers via our website and update the instructions.

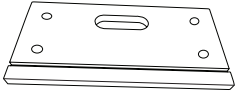
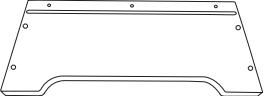
All you need to do is drop us a line at [**instructions@gltc.co.uk**](mailto:instructions@gltc.co.uk)

Thank you.

Component Check List

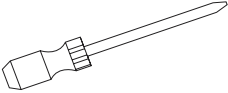
<p>A</p>  <p>x2 Panel A</p>	<p>B</p>  <p>x2 Panel B</p>
<p>C</p>  <p>x1 Panel C</p>	<p>D</p>  <p>x1 Panel D</p>
<p>E</p>  <p>1x Panel E</p>	<p>#1</p>  <p>8x Cam Dowels</p>
<p>#2</p>  <p>8x Cam Locks</p>	<p>#3</p>  <p>6x 20mmL Screws</p>
<p>You will need (not supplied)</p>  <p>Philips Head Screwdriver</p>	

Hardware for Step I:

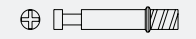

8x #1 Cam Dowels



6x #3 20mmL Screws

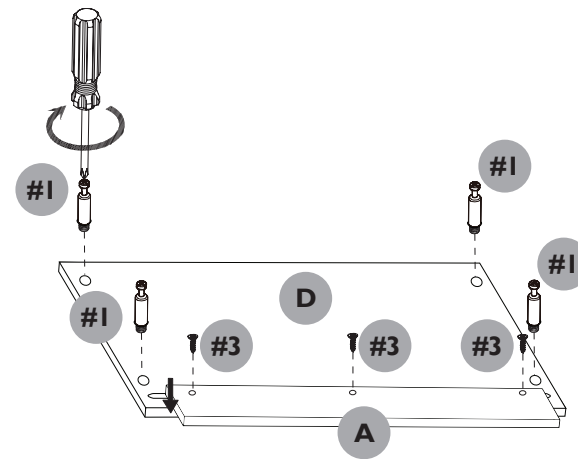

Ensure routed edge on panel A is facing outwards.

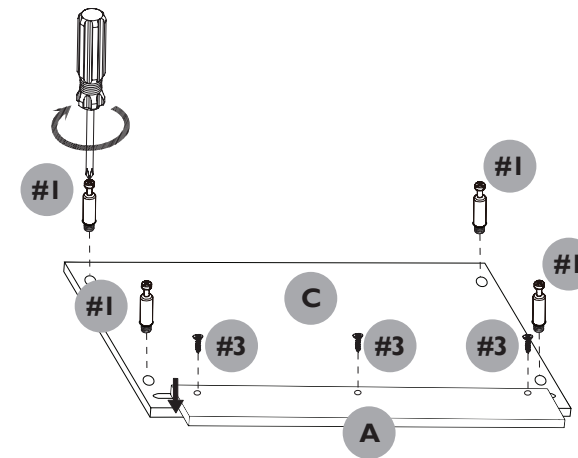

Ensure routed edge on panel A is facing outwards.

STEP I:

Attach the two panel As to panel D and C using 6x screws (#3).

Insert 8x cam dowels (#1) into panels D and C.

Hardware for Step 2:



4x #2 Cam Locks

Ensure cam locks are fully tightened.

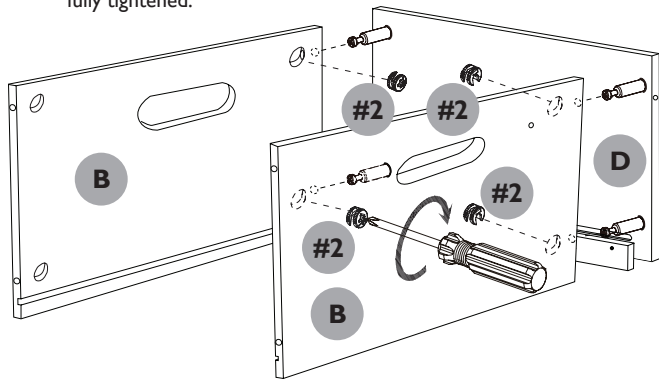

STEP 2:

Attach 2x panels B to panel D using 4x cam locks (#2).

Ensure cam locks are fully tightened.

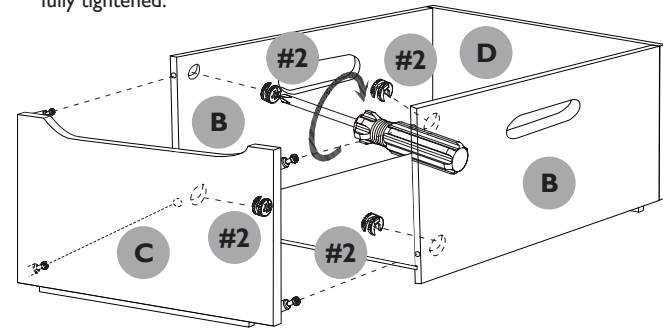

STEP 4:

Attach 2x panels B to panel C using 4x cam locks (#2).

Hardware for Step 4:



4x #2 Cam Locks

STEP 3:

Slot panel E into the grooves in panels B,B and D.

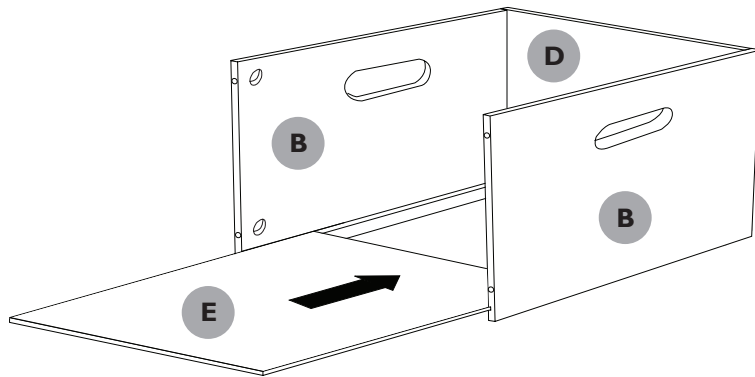

STEP 5:

Your unit is ready to use.

