

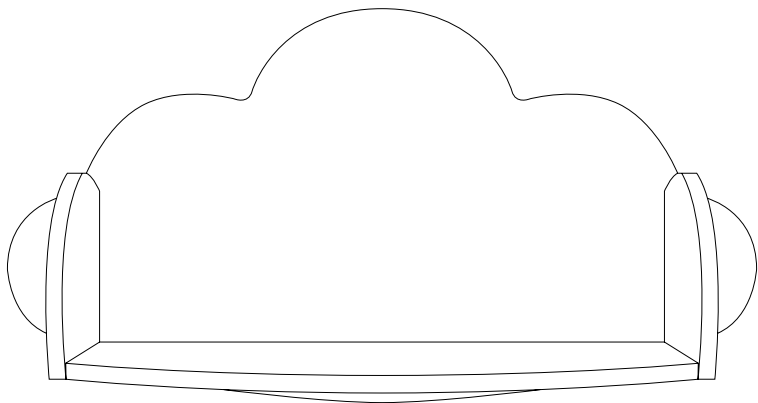

gltc.co.uk

Cloud Wall Shelf

L4277



Thank you for shopping with GLTC, we hope you enjoy having this product in your home.

We know assembling furniture, toys or accessories is not everyone's favourite way to spend their time, so we've tried to make assembling this item as quick and painless as possible.

Hopefully our efforts will have been worthwhile and you'll sail through the whole process. But if it all feels a bit too much like hard work, then we do have an assembly company we can recommend: the Flatpack Construction Company offers a nationwide service and can be contacted on **0843 289 4951** or **www.flatpackconstruction.co.uk**.

A few important pointers before you start:

- Please read the instructions right through before you start, and check that all the components have been included in the pack; we find separating all the hardware into piles makes it easier to be sure that everything is present and correct.
- Make sure you have the right tools. Allen keys are provided if required, but screw drivers and other tools are not. You'll find details of the tools you need at the beginning of the instructions.
- It's a good idea to build the unit in the room where you are going to be using it, to avoid the need to move it after it's been assembled.
- Do not throw away any packing materials until assembly is complete, just in case you accidentally discard smaller parts or hardware.

Assembly Difficulty



easy - medium - hard



one-person job



04/05/2017

Safety Warnings:

- Adult assembly required.
- Unassembled product contains small parts which may present a choking hazard.
- Children should be kept away from the product during assembly to avoid any possible risk of injury.
- DO NOT use power tools in the assembly of this product as there is a risk of over-tightening and consequently splitting of the wood.
- Wall fixings are not included. Please use wall fixings that are suitable for the wall type. If in doubt, please seek professional advice
- Check all fixtures and fittings regularly and tighten as necessary.
- Maximum weight 20kg. Do not overload.
- Please retain these instructions for future reference.

Customer Service:

- If you find that any components are missing or damaged, please do not begin assembly and do not use the item. Please contact GLTC Customer Services on **0344 848 6000** immediately.
- We do stock spare hardware packs at our warehouse, so we should be able to send you a replacement pack immediately if required.

Product Care:

- Wipe clean using a soft damp cloth followed by a dry cloth.
- Do NOT use cleaning products which contain ammonia, solvents or abrasive material.
- Do NOT expose the item to extremes of heat and humidity.



Could we do better?

If there is anything you think could be improved in these instructions or in the assembly of this product we'd be grateful if you could let us know; we'll pass any helpful hints and tips on to other customers via our website and update the instructions.

All you need to do is drop us a line at [**instructions@gltc.co.uk**](mailto:instructions@gltc.co.uk)

Thank you

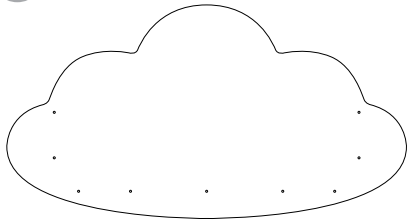
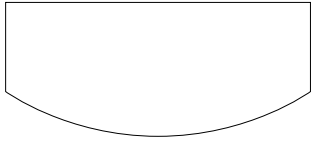
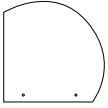
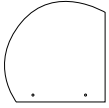
Component Check List

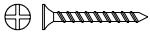
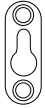
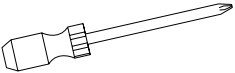
<p>A</p>  <p>1x Cloud Backboard</p>	<p>B</p>  <p>1x Shelf</p>
<p>C</p>  <p>1x Left Hand Side Panel</p>	<p>D</p>  <p>1x Right Hand Side Panel</p>
<p>#1</p>  <p>4x Screws 10mmL</p>	<p>#2</p>  <p>1 x Screws 25mmL</p>
<p>#3</p>  <p>2x Wall Fixings</p>	<p>#4</p> <p>You will need (not supplied)</p>  <p>Phillips Head Screwdriver</p>

Hardware for Step 1:



2x #3 wall fixings



4x #1 10mmL screws

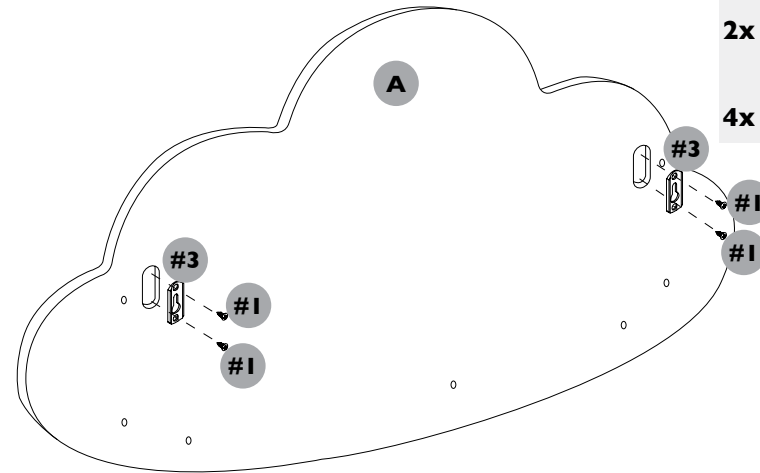

STEP 1:

Attach 2x wall fixings (#2) to the back of panel A using 4x screws (#1).

STEP 2:

Attach left hand side panel (C) to shelf (B) using 2x screws (#2).

The countersunk holes should be outward facing.

Hardware for Step 2:



2x #2 25mmL screws

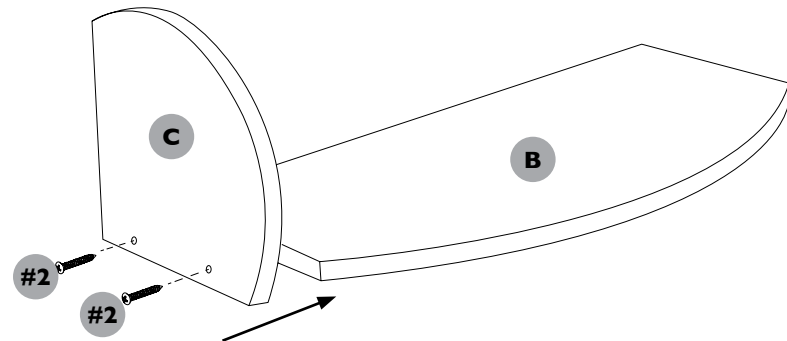

Hardware for Step 3:

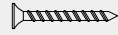

x2 #2 25mmL screws

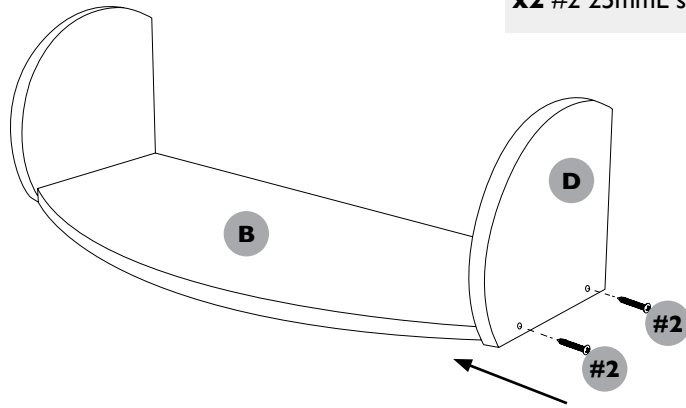

STEP 3:

Attach right hand side panel (D) to shelf (B) using 2x screws (#2).

The countersunk holes should be outward facing.

Assembly is now complete.

When hanging please use the correct hardware for your wall type, if unsure please seek professional advice.

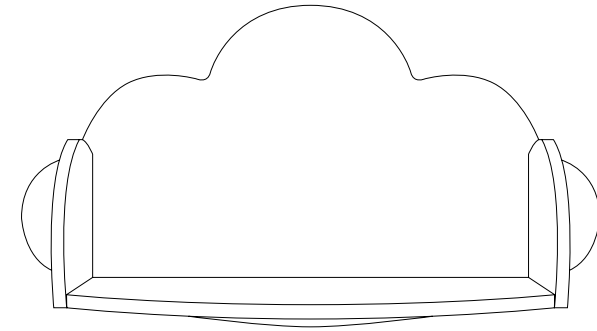

STEP 4:

Attach cloud backboard panel (A) to panels B,C and D using 7x screws (#2).

Hardware for Step 4:

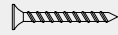

x7 #2 25mmL screws

