

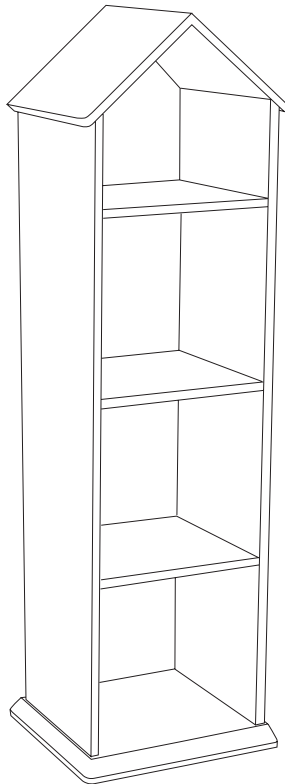

www.gltc.co.uk

Townhouse Bookcase



Assembly Difficulty



easy - medium - hard



one-person job

V3

18/08/2017

Thank you for shopping with GLTC, we hope you enjoy having this product in your home.

We know assembling furniture, toys or accessories is not everyone's favourite way to spend their time, so we've tried to make assembling this item as quick and painless as possible.

Hopefully our efforts will have been worthwhile and you'll sail through the whole process. But if it all feels a bit too much like hard work, then we do have an assembly company we can recommend: the Flatpack Construction Company offers a nationwide service and can be contacted on **0843 289 4951** or **www.flatpackconstruction.co.uk**.

A few important pointers before you start:

- Please read the instructions right through before you start, and check that all the components have been included in the pack; we find separating all the hardware into piles makes it easier to be sure that everything is present and correct.
- Make sure you have the right tools. Allen keys are provided if required, but screw drivers and other tools are not. You'll find details of the tools you need at the beginning of the instructions.
- It's a good idea to build the unit in the room where you are going to be using it, to avoid the need to move it after it's been assembled.
- Do not throw away any packing materials until assembly is complete, just in case you accidentally discard smaller parts or hardware.

Safety Warnings:

- Adult assembly required.
- Unassembled product contains small parts which may present a choking hazard.
- Children should be kept away from the product during assembly to avoid any possible risk of injury.
- Assemble and use on a flat and level surface.
- DO NOT use power tools in the assembly of this product as there is a risk of over-tightening and consequently splitting of the wood.
- Always use the wall straps provided.
- DO NOT allow children to climb on these shelves.
- Serious or fatal crushing injuries can occur from furniture tipping over. Ensure you secure this furniture product to the wall before you use it using the kit provided. If you have not received an anti-tip kit with your product please contact Customer Services.
- Check all fixtures and fittings regularly and tighten as necessary.
- Please retain these instructions for future reference.

Customer Service:

- If you find that any components are missing or damaged, please do not begin assembly and do not use the item. Please contact GLTC Customer Services on **0344 848 6000** immediately.
- We do stock spare hardware packs at our warehouse, so we should be able to send you a replacement pack immediately if required.

Product Care:

- Wipe clean using a soft damp cloth followed by a dry cloth.
- Do NOT use cleaning products which contain ammonia, solvents or abrasive material.
- Do NOT expose the item to extremes of heat and humidity.







Could we do better?



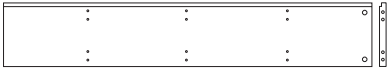

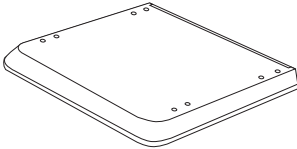

If there is anything you think could be improved in these instructions or in the assembly of this product we'd be grateful if you could let us know; we'll pass any helpful hints and tips on to other customers via our website and update the instructions.

All you need to do is drop us a line at [**instructions@gltc.co.uk**](mailto:instructions@gltc.co.uk)

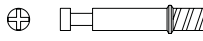
Thank you

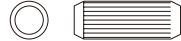
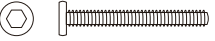
Component Check List

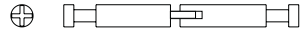
<p>A</p>  <p>1x Right Side Panel</p>	<p>B</p>  <p>1x Left Side Panel</p>
<p>C</p>  <p>3x Shelves</p>	<p>D</p>  <p>1x Base Plinth</p>
<p>E</p>  <p>1x Right Roof Panel</p>	<p>F</p>  <p>1x Left Roof Panel</p>
<p>G</p>  <p>1x Upper Back Panel</p>	<p>H</p>  <p>1x Lower Back Panel</p>

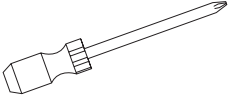
<p>#1</p>  <p>12x Cam Dowels 35mmL</p>	<p>#2</p>  <p>16x Cam Locks 14mm Diameter</p>
<p>#3</p>  <p>20x Wooden Dowels 20mmL</p>	<p>#4</p>  <p>4x Bolts 66mmL</p>
<p>#5</p>  <p>4x Barrel Nuts</p>	<p>#6</p>  <p>10x Screws 16mmL</p>
<p>#7</p>  <p>2x Jointed Cam Dowels 84mmL</p>	<p>#8</p>  <p>4x Screws 22mmL</p>
 <p>1x Allen Key</p>	<p>You will need (not supplied)</p>  <p>Philips Head Screwdriver</p>

STEP 1:

Working on a surface such as carpet, place the two side panels on the floor. Insert hardware (#1) into the two side panels (A & B) using a Phillips screwdriver.

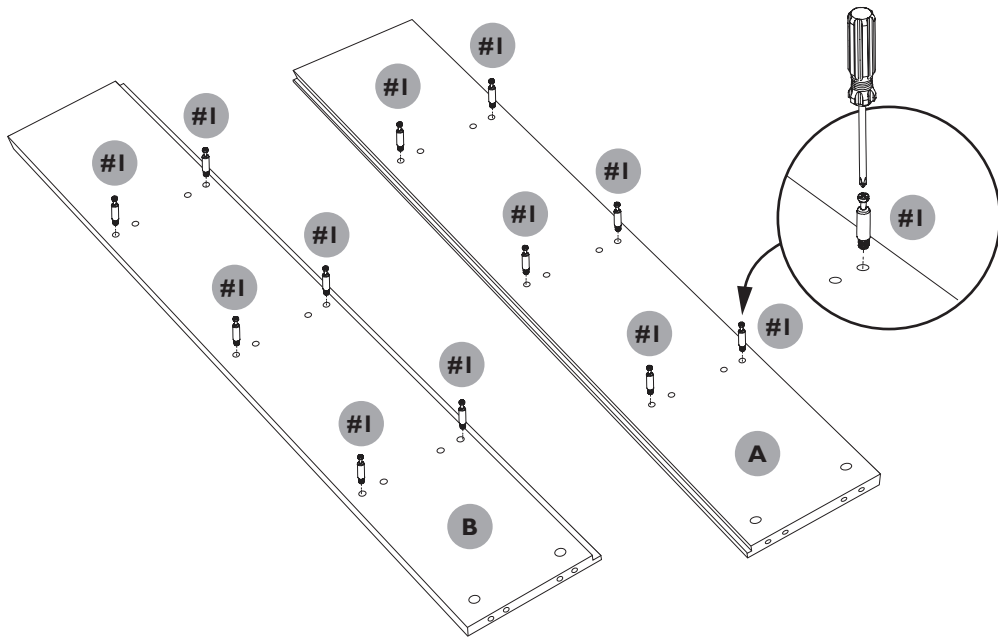

Hardware for Step 1:

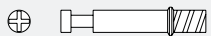

12x #1 Cam Dowels

Hardware for Step 2:



6x #2 Cam Locks



6x #3 Wooden Dowels

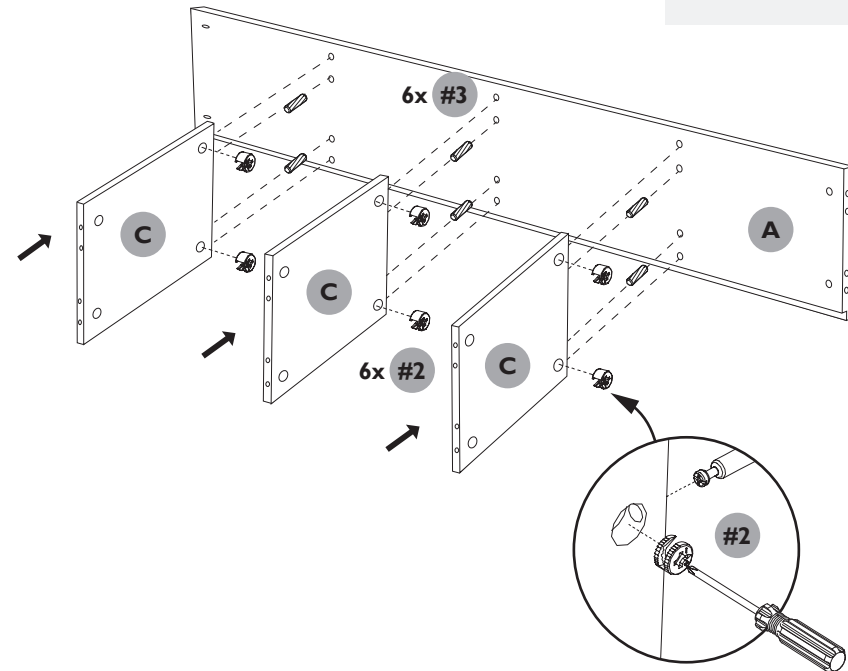

STEP 2:

Position side panel A as shown with the drill holes on the face of the panel facing towards you and the shaped edge towards the floor.

Insert 6 x wooden dowel (#3) into the holes next to the cam dowels and push the shelves (C) into place. Note the holes on the underside of the shelves should be facing as shown, towards the larger of the drill holes on the side panel and what will be the base of the unit.

To secure the shelves in position, insert 6 x cam lock (#2) into the large drill holes on the shelves and turn them 180 degrees clockwise to lock them.

STEP 3:

Attach the remaining Side Panel B to the shelves as in step 2, using the wooden dowels (#3) and cam locks (#2).

Ensure the cam locks are tightened securely by turning 180 degrees clockwise.

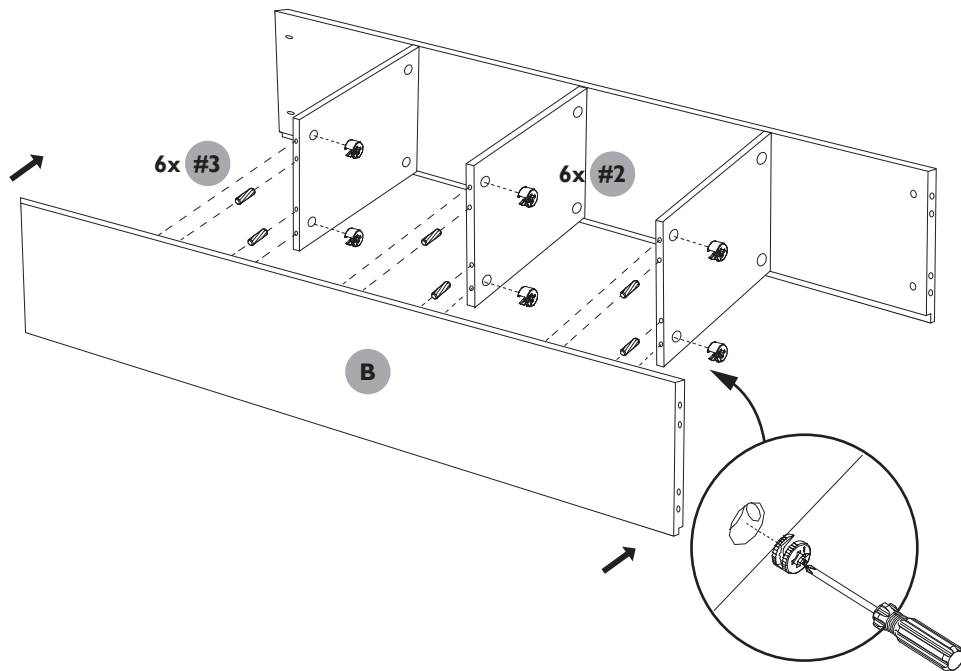

Hardware for Step 3:



6x #2 Cam Locks



6x #3 Wooden Dowels

Hardware for Step 4:



4x #3 Wooden Dowels

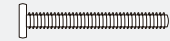

4x #4 Bolts



4x #5 Barrel Nuts

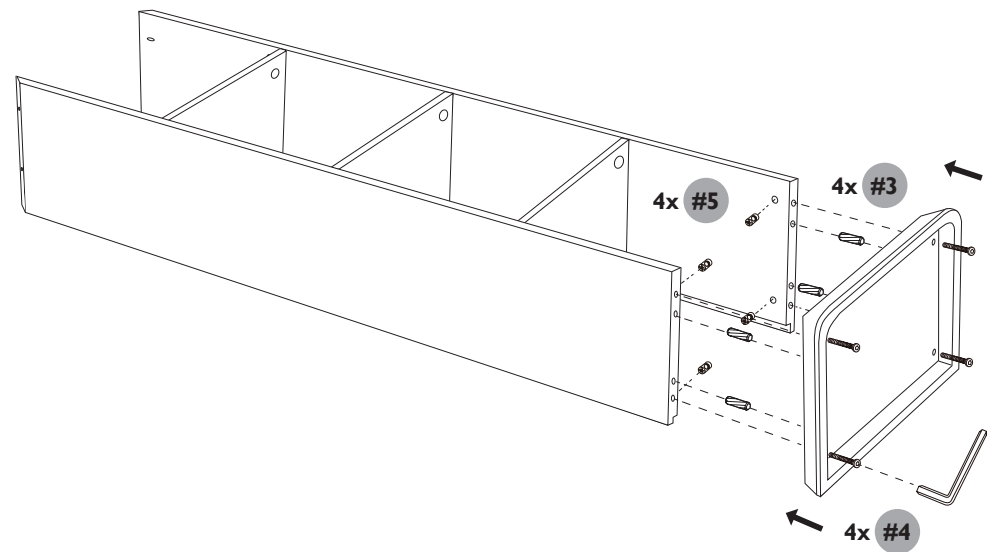

STEP 4:

Attach the base plinth to the unit. Insert 4 x wooden dowel (#3) to the ends of the side panels as shown. Insert 4 x barrel nut (#5) to the holes on the inside of the side panels, ensuring the hole in the nut is facing towards the base. Push the base into position and fix in place using 4 x bolt (#4). Tighten fully using the Allen key provided (#10).

STEP 5:

Create the pitched roof by joining Panels E & F with the jointed cam dowels (#7)

Once in place, insert 4 x cam lock (#2) into the large holes and turn 180 degrees clockwise to lock in place.

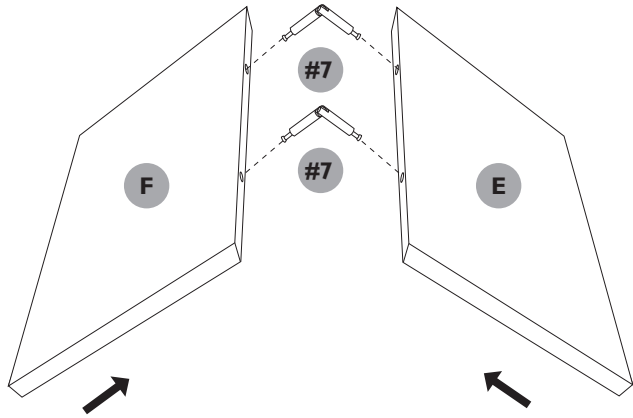

Hardware for Step 5:



4x #2 Cam Locks



2x #7 Jointed Cam Dowels

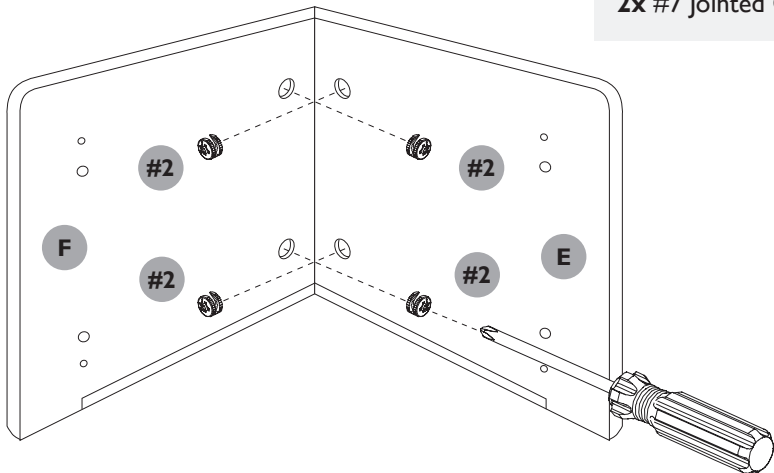

STEP 6:

Stand the unit up on its base. Attach the roof to the unit by first inserting 4 x wooden dowel (#3) into the holes on the top edges of the side panels. Push the roof into place onto the dowels and then insert 4 x screw (#8) to fix into place with a Phillips screwdriver.

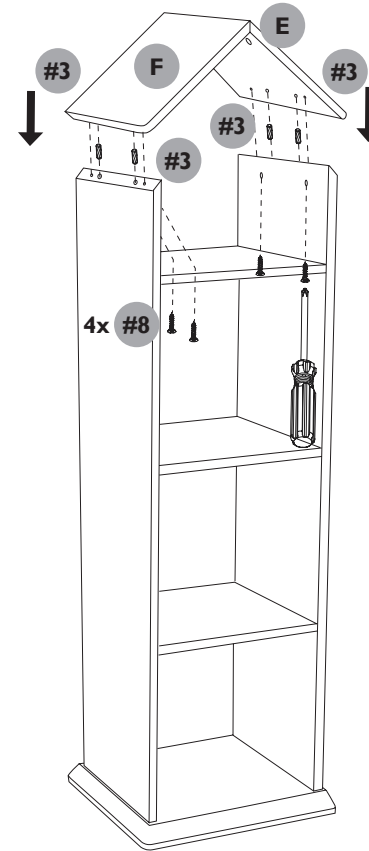

Hardware for Step 6:



4x #3 Wooden Dowels



4x #8 22mmL Screws

STEP 7:

Attach the back panels. Position the lower back panel H first and fix in place with 6 x screw (#6). Then attach upper back panel G with 4 x screw (#6) on the straight sides.

Please note that the 2x pilot holes indicated at the top of the unit are to attach anti-tip straps included separately with this item.

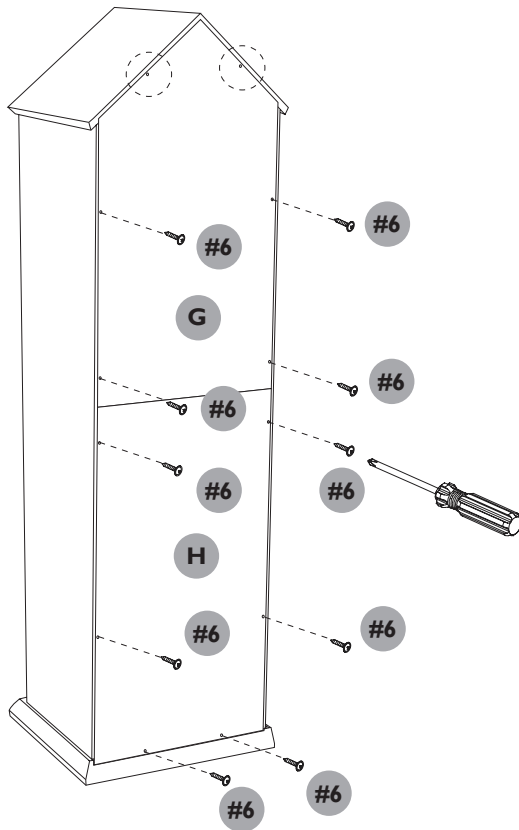

Hardware for Step 7:



10x #6 16mmL Screws

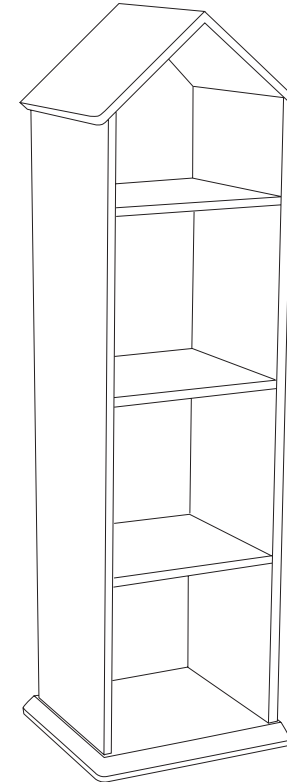

Your unit is ready to use.

Please be aware that we advise that safety straps are used to secure this to the wall, for details on securing the unit to the wall see the anti-tip kit guidance. Alternative furniture safety straps are available at www.gltc.co.uk

© Copyright G.L.T.C. Ltd. 2015.

G.L.T.C. asserts all product design rights, all other intellectual property and image rights including those contained in these instructions.