

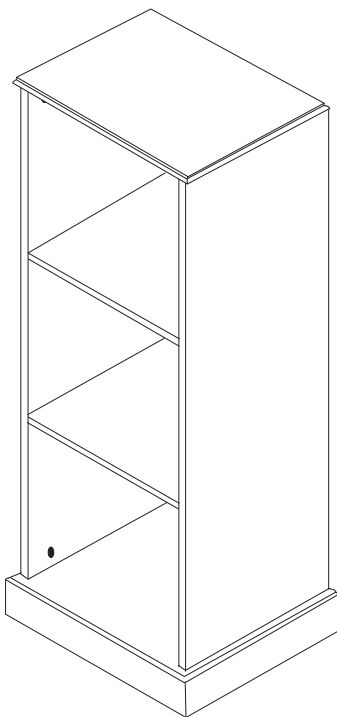

www.gltc.co.uk

## Abbeville 3 Cube Tallboy Unit

L2933/L2944



**Thank you for shopping with GLTC, we hope you enjoy having this product in your home.**

We know assembling furniture, toys or accessories is not everyone's favourite way to spend their time, so we've tried to make assembling this item as quick and painless as possible.

Hopefully our efforts will have been worthwhile and you'll sail through the whole process. But if it all feels a bit too much like hard work, then we do have an assembly company we can recommend: the Flatpack Construction Company offers a nationwide service and can be contacted on **0843 289 4951** or **www.flatpackconstruction.co.uk**.

### **A few important pointers before you start:**

- Please read the instructions right through before you start, and check that all the components have been included in the pack; we find separating all the hardware into piles makes it easier to be sure that everything is present and correct.
- Make sure you have the right tools. Allen keys are provided if required, but screw drivers and other tools are not. You'll find details of the tools you need at the beginning of the instructions.
- It's a good idea to build the unit in the room where you are going to be using it, to avoid the need to move it after it's been assembled.
- Do not throw away any packing materials until assembly is complete, just in case you accidentally discard smaller parts and hardware.

Assembly Difficulty



easy - medium - hard



one-person job

V2

24/01/2017

### **Safety Warnings:**

- Adult assembly required.
- Children should be kept away from the product during assembly to avoid any possible risk of injury.
- Assemble and use on a flat and level surface.
- Do not use power tools in the construction of this product.
- Cam locks are used in the assembly of this unit. There is a natural stopping point when turning, do not over-tighten.
- Always use the wall straps provided.
- Check fixtures and fittings regularly and tighten as necessary.
- Please retain these instructions for future reference.

### **Customer Service:**

- If you find that any components are missing or damaged, please do not begin assembly and do not use the item. Please contact GLTC Customer Services on **0344 848 6000** immediately.
- We do stock spare hardware packs at our warehouse, so we should be able to send you a replacement pack immediately if required.

### **Product Care:**

- Wipe clean using a soft damp cloth followed by a dry cloth.
- Do NOT use cleaning products which contain ammonia, solvents or abrasive material.
- Do NOT expose the item to extremes of heat and humidity.

### **Could we do better?**

If there is anything you think could be improved in these instructions or in the assembly of this product we'd be grateful if you could let us know; we'll pass any helpful hints and tips on to other customers via our website and update the instructions.

All you need to do is drop us a line at [\*\*instructions@gltc.co.uk\*\*](mailto:instructions@gltc.co.uk)

Thank you

## Component Check List: All Hardware

#1 16 x Wooden Dowels



#2 12 x Cam Dowels

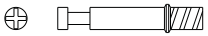

#3 12 x Cam Locks



#4 4 x Screws  
42mmL



You will need:  
(not supplied)

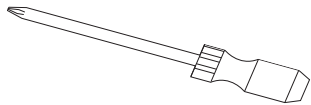

Phillips Head Screwdriver

#5 4 x Barrel Nuts

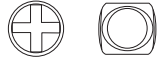

#6 12 x Screws  
12mmL



#7 1 x Anti-tip Strap

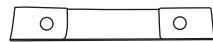

#8 1 x Screw  
14mmL

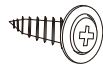

#9 1 x Allen Key



## Component Check List

A 1 x Right Side Panel

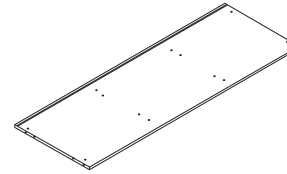

B 1 x Left Side Panel

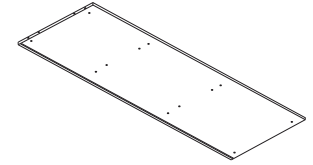

C 2 x Shelves

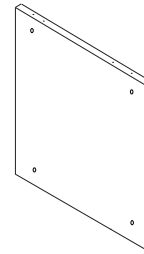

D 1 x Back Panel

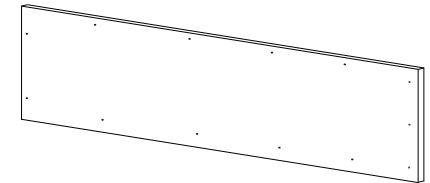

E 1 x Base Panel

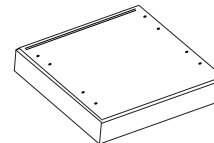

F 1 x Top Panel

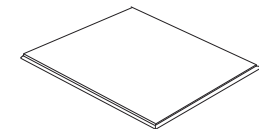

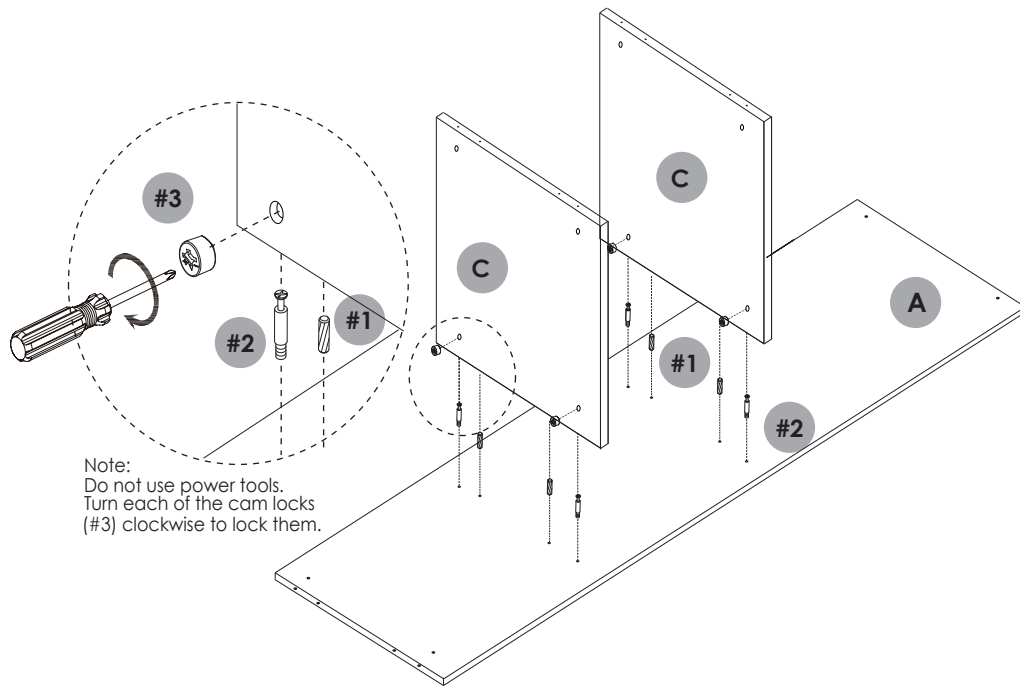

**Hardware for Step 1:**



**4x #1** Wooden Dowels

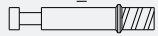

**4x#2** Cam Dowels



**4x #3** Cam Locks

**Step 1: Prepare the side panel A**

*Note: Do not over-tighten the cam dowels.*

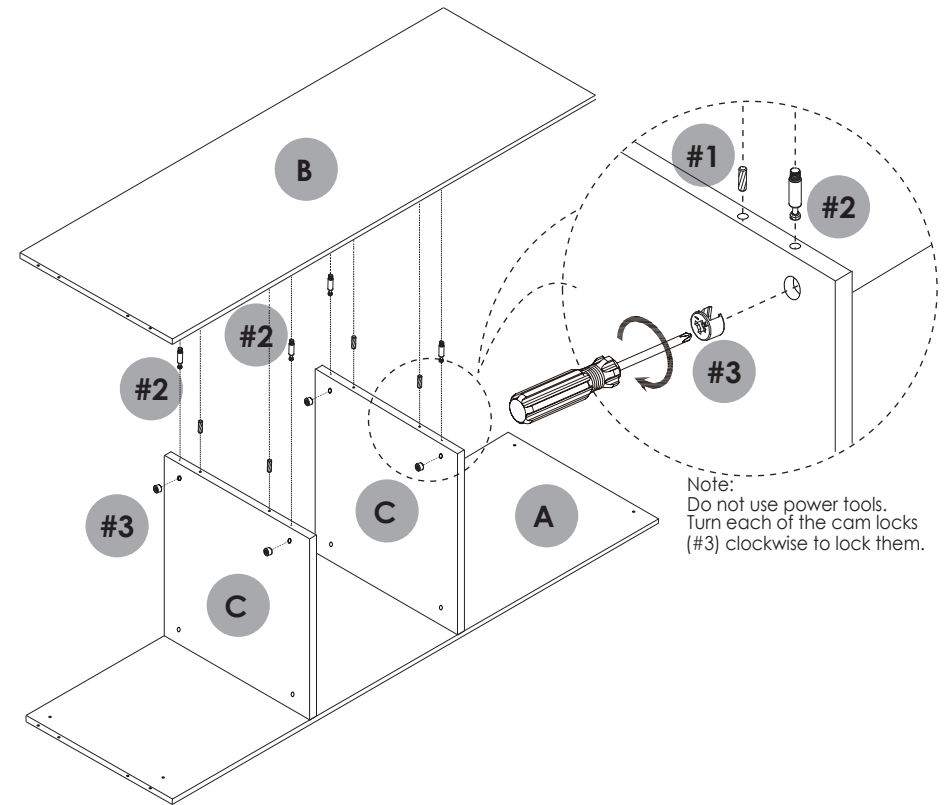

**Hardware for Step 2:**



**4x #1** Wooden Dowels

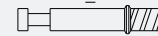

**4x#2** Cam Dowels



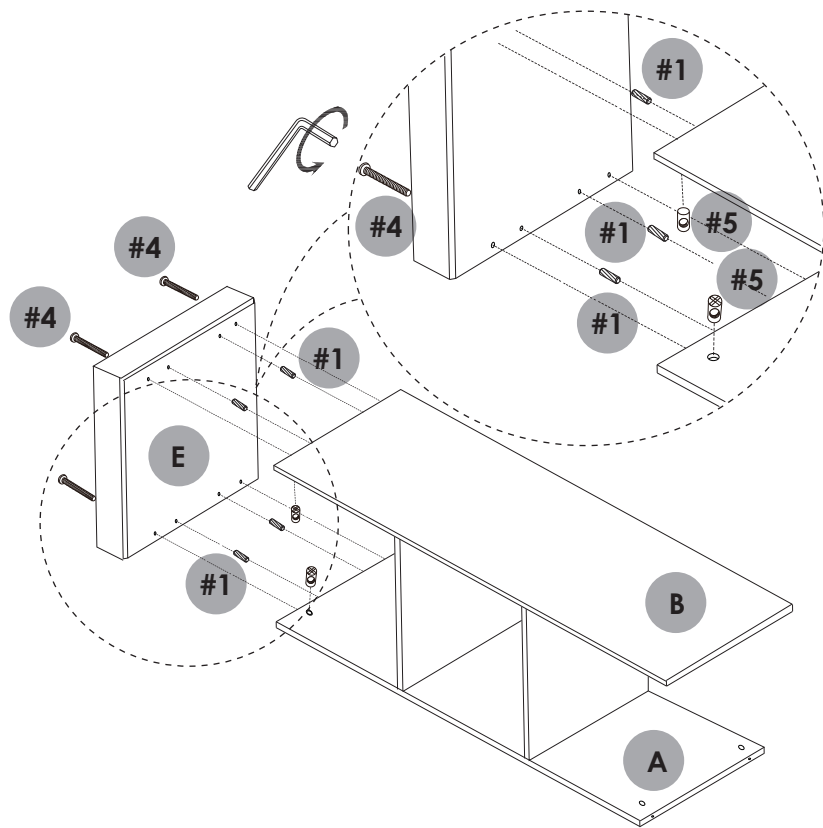

**4x #3** Cam Locks

**STEP 2: Attach the other side panel B**



**Hardware for Step 3:**

-  4x #1 Wooden Dowels
-  4x #4 Bolts
-  4x #5 Bolts Nuts

**STEP 3: Attach the base panel E**

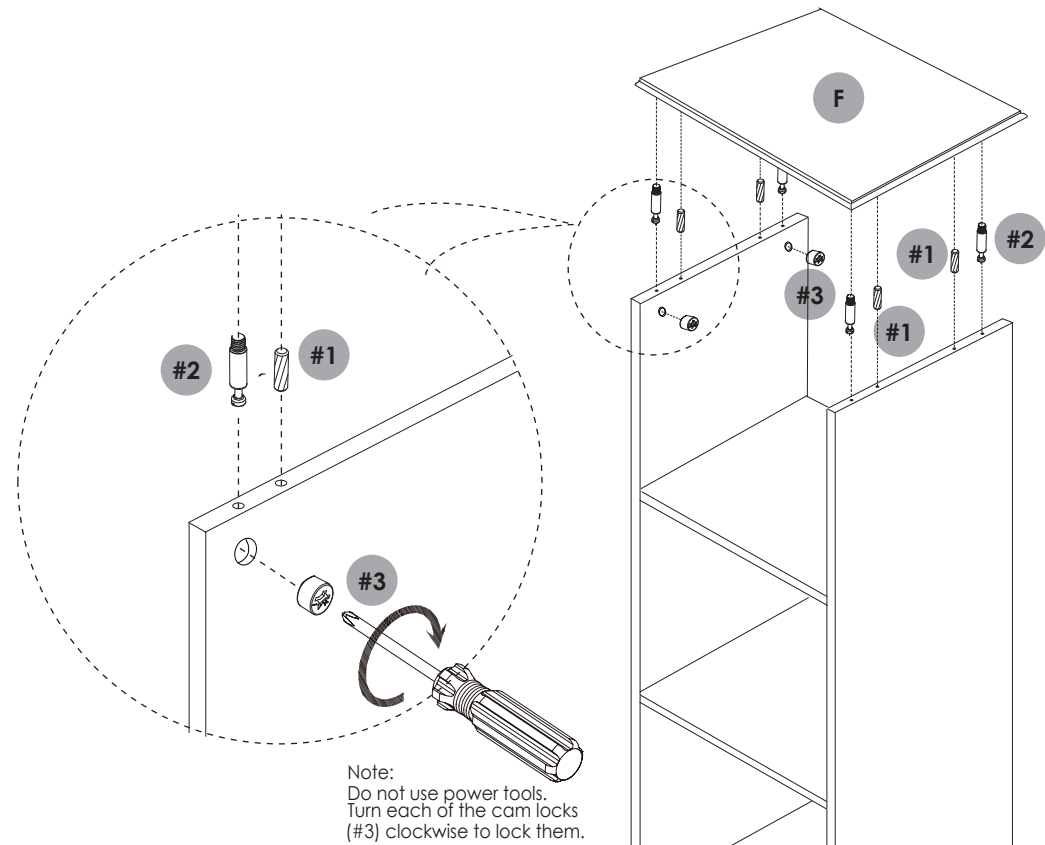

Note:  
Do not use power tools.  
Turn each of the cam locks  
(#3) clockwise to lock them.

**Hardware for Step 4:**

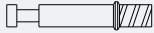
-  4x #1 Wooden Dowels
-  4x #2 Cam Dowels
-  4x #3 Cam Locks

**STEP 4: Attach the top panel F**

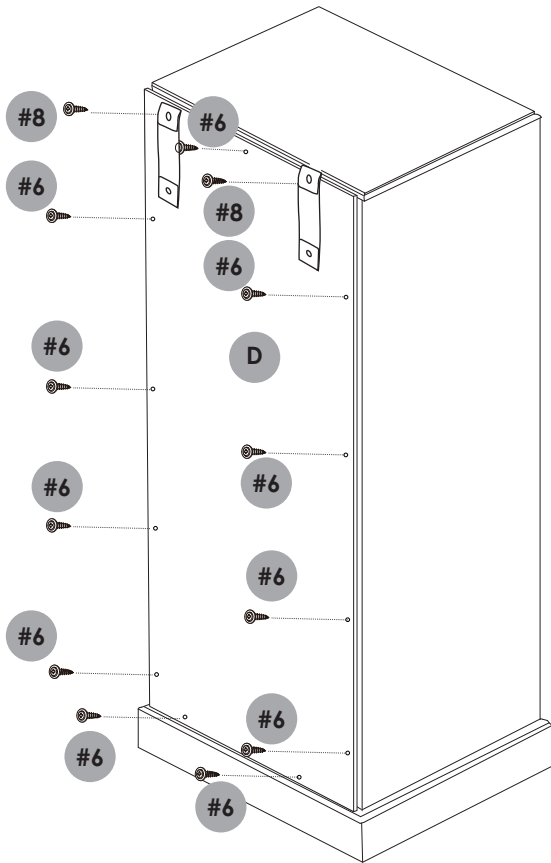

**Hardware for Step 5:**



11x #6 Screws

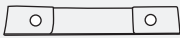

2x #7 Anti-tip Straps

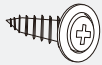

2x #8 Screws

**STEP 5: Attach the back panel D and the anti-tip straps**

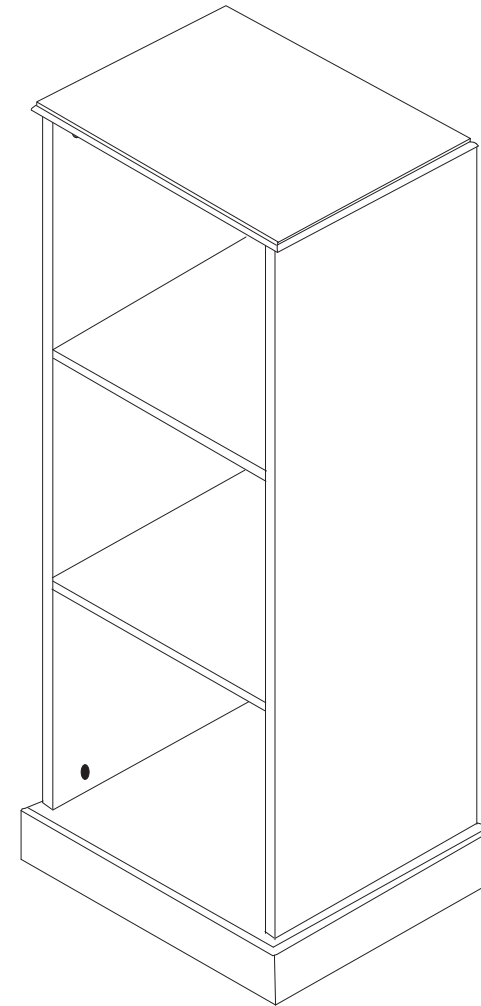

**READY TO USE**

© Copyright G.L.T.C. Ltd. 2015.  
G.L.T.C. asserts all product design rights, all other intellectual property and image rights including those contained in these instructions.