

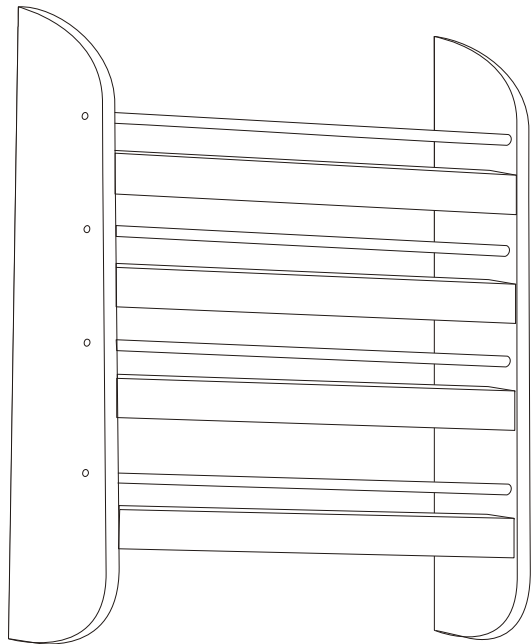

gltc.co.uk

Greenaway Gallery Bookcase



Assembly Difficulty



easy - medium - hard



one-person job

V3

22/05/2018

Thank you for shopping with GLTC, we hope you enjoy having this product in your home.

We know assembling furniture, toys or accessories is not everyone's favourite way to spend their time, so we've tried to make assembling this item as quick and painless as possible.

Hopefully our efforts will have been worthwhile and you'll sail through the whole process. But if it all feels a bit too much like hard work, then we do have an assembly company we can recommend: the Flatpack Construction Company offers a nationwide service and can be contacted on **0843 289 4951** or **www.flatpackconstruction.co.uk**.

Good luck!

A few important pointers before you start:

- It might be worth checking on our website that there are no updates or revisions to these instructions (if we have had helpful feedback from other customers we pass it on via the product web page). Simply check the date and version number on the front of this leaflet against that of any site updates.
- Please read the instructions right through before you start, and check that all the components have been included in the pack; we find separating all the hardware into piles makes it easier to be sure that everything is present and correct.
- Make sure you have the right tools. Allen keys are provided if required, but screw drivers and other tools are not. You'll find details of the tools you need at the beginning of the instructions.
- It's a good idea to build the unit in the room where you are going to be using it, to avoid the need to move it after it's been assembled.
- Do not throw away any packing materials until assembly is complete, just in case you accidentally discard smaller parts or hardware.

Safety Warnings:

- Adult assembly required.
- Assembly to be carried out by a competent adult only. During assembly children should be kept away from the product due to possible risk of injury. Do not use this item if any components are missing or damaged.
- In an unassembled state product contains small parts which may pose a choking hazard, not suitable for children under 3 years.
- DO NOT use power tools in the assembly of this product as there is a risk of over-tightening and consequently splitting of the wood.
- DO NOT let children climb or hang on drawers, doors or shelves.
- Max Shelf Loading: 5kgs.
- Wall fixings not included. Please use appropriate fixings that are suitable for the wall type. If in doubt, please seek professional advice.
- Regularly check all fixtures and fittings to ensure that they properly tightened and tighten as necessary.
- Please retain these instructions for future reference.
- Made in China.

Customer Service:

- If you find that any components are missing or damaged, please do not begin assembly and do not use the item. Please contact GLTC Customer Services on **0344 848 6000** immediately.
- We do stock spare hardware packs at our warehouse, so we should be able to send you a replacement pack immediately if required.

Product Care:

- Wipe clean only.
- Do NOT use cleaning products which contain ammonia, solvents or abrasive material.
- Do NOT expose the item to extremes of heat and humidity.



Could we do better?

If there is anything you think could be improved in these instructions or in the assembly of this product we'd be grateful if you could let us know; we'll pass any helpful hints and tips on to other customers via our website and update the instructions.



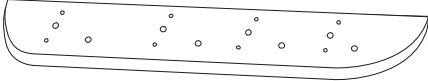

All you need to do is drop us a line at instructions@gltc.co.uk

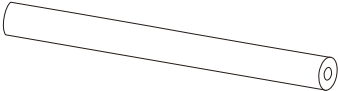
Thank you.

Component Check List

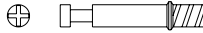
| | |
|---|--|
| <p>A</p>  <p>1x Left Side Panel</p> | <p>B</p>  <p>1x Right Side Panel</p> |
| <p>C</p>  <p>4x Shelves</p> | <p>D</p>  <p>4x Shelf Rods</p> |

Component Check List

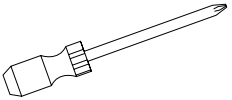
| | |
|--|---|
| <p>#1</p>  <p>8x Cam Dowels 35mmL</p> | <p>#2</p>  <p>8x Cam Locks 14mm Diameter</p> |
| <p>#3</p>  <p>16x Wooden Dowels 20mmL</p> | <p>#4</p>  <p>8x Bolts</p> |
| <p>#5</p>  <p>1x Allen Key</p> | <p>You will need (not supplied)</p>  <p>Philips Head Screwdriver</p> |
| <p>You will need (not supplied)</p> <p>x4 Screws and Wall Plugs (if appropriate) for your wall type. See installation guide for details.</p> | |

Installation Guide

PLEASE READ BEFORE ASSEMBLING THE BOOKCASE:

Decide where you intend to fit the bookcase. Check the wall for pipes and cables and ensure that you have a spirit level, pencil, tape measure, drill and drill bits to hand.

Take one of the side panels (either A or B), and place the panel with the outside face flat against the wall, whilst ensuring the narrow part of the keyhole fixing slot is uppermost. Ensure that the panel is vertically straight using the spirit level.

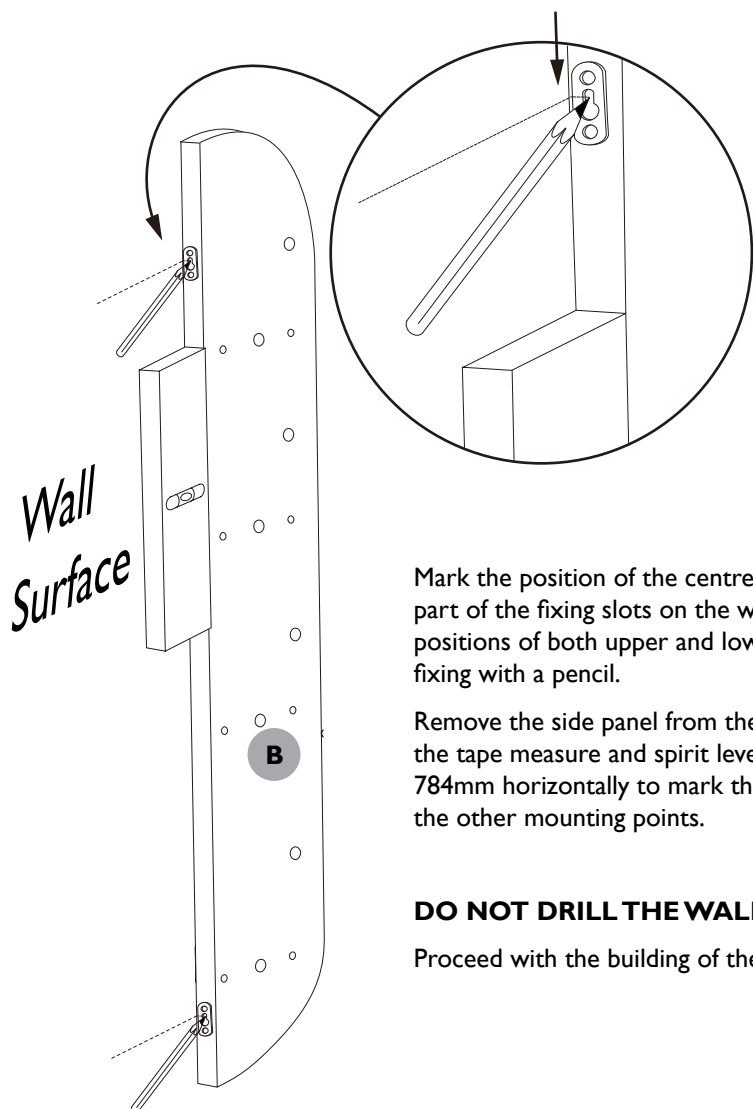

Mark the position of the centre of the narrow part of the fixing slots on the wall. Mark the positions of both upper and lower keyhole fixing with a pencil.

Remove the side panel from the wall and using the tape measure and spirit level, measure 784mm horizontally to mark the centres for the other mounting points.

DO NOT DRILL THE WALL YET

Proceed with the building of the unit.

Installation Guide

AFTER ASSEMBLING THE BOOKCASE:

Start by checking the measurements between all the centres of the keyhole fixings on the built bookcase are the same as those marked on the wall. If there is a slight difference, re-measure and adjust the wall markings until you are satisfied that these are all correct.

Hardware: You must use hardware that is suitable for the wall where the bookcase is to be mounted. It is not provided.

Ensure you have 4 suitable length countersunk screws/hardware and that the heads of the screw locate and slide up into the narrow part of the keyhole fixing plates without pulling out. If they are needed for your wall type, also ensure that you also have the correct size wall plugs for the screws you are using and that you have the correct sized drill bit to suit too.

The bookcase can hold up to 20kgs of books, so needs to be firmly fixed to the wall.

If you are unsure, we recommend seeking professional advice before proceeding further.

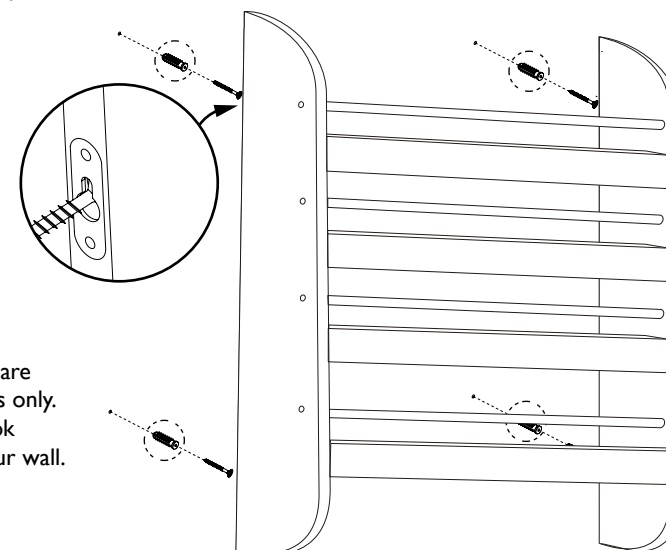

Hardware shown here are for illustrative purposes only. Your hardware may look slightly different for your wall.

Drill the holes in the wall and fit the wall plugs (if using). Add the screws and ensure that the head of the screw is sufficiently proud of the wall to locate into the keyhole fixing slots.

Carefully offer up the bookcase to the 4 screws and once each is located correctly, move the unit down to secure to the wall. Each screw head may need to be adjusted in or out slightly to help with each location point.

ALL 4 KEYHOLE FIXINGS MUST BE USED TO LOCATE THE BOOKCASE.

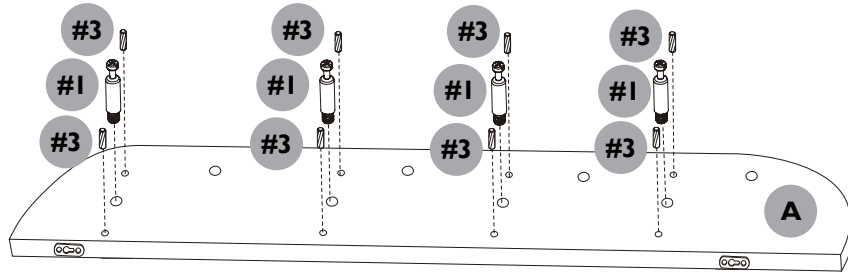

Hardware for Step 1:

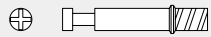

4x #1 Cam Dowels



8x #3 Wooden Dowels

STEP 1:

Insert x4 cam dowels (#1) and x8 wooden dowels (#3) to side panel A.

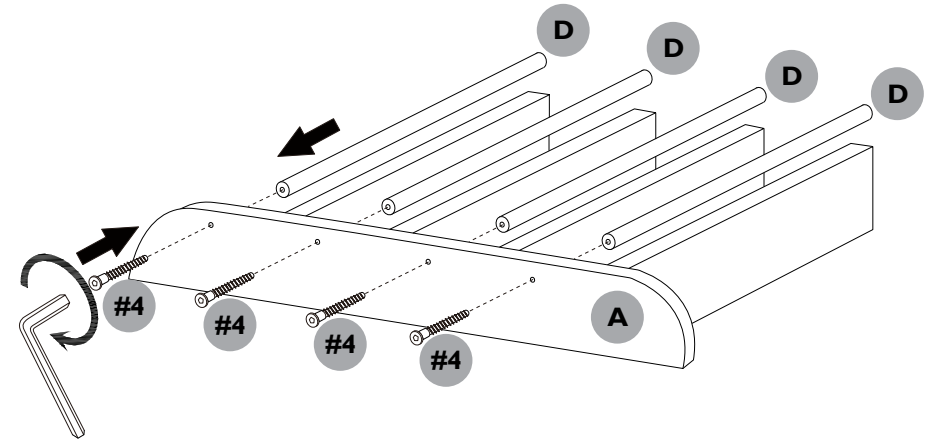

Hardware for Step 3:



4x #4 Bolts

STEP 3:

Attach the rods using x4 bolts (#4).

Hardware for Step 2:



4x #2 Cam Locks

STEP 2:

Attach the shelf panels C to the left side panel A with x4 cam locks (#2).

Note: The lip of the shelf panels should be at the front of panel A facing upwards. The back of panel A is highlighted by the keyhole hooks.

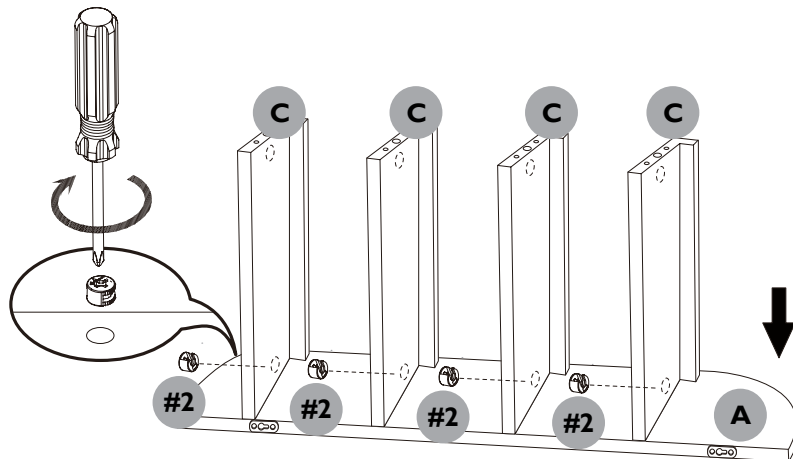

STEP 4:

Insert x4 cam dowels (#1) to side panel B.

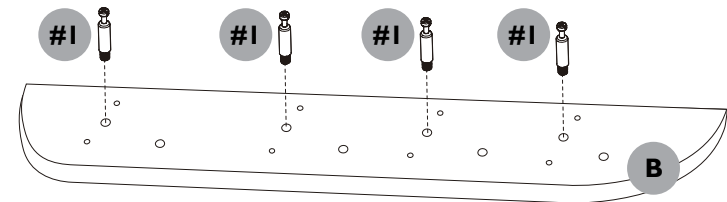

Hardware for Step 4:



4x #1 Cam Dowels

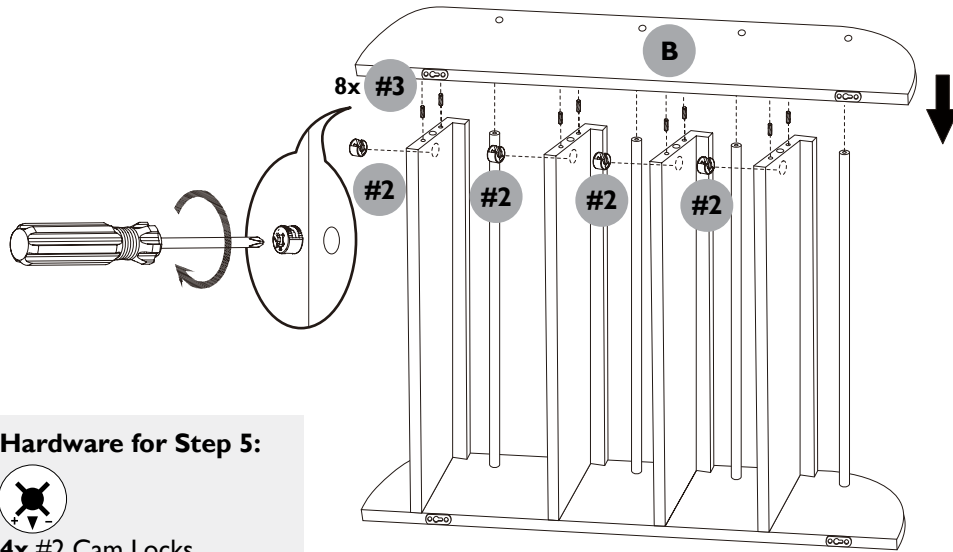

Hardware for Step 5:



4x #2 Cam Locks



8x #3 Wooden Dowels

STEP 5:

Position the right side panel B using x8 wooden dowels (#3) and secure into place with x4 cam locks (#2).

STEP 6:

Secure the right side panel B using the remaining x4 bolts (#4).

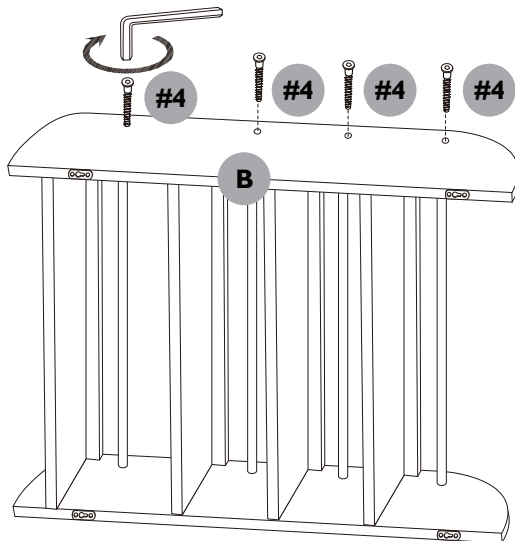

Hardware for Step 6:



4x #4 Bolts

STEP 7:

The bookcase is now ready to mount to the wall. Please refer to the installation guide for wall mounting instructions.

