

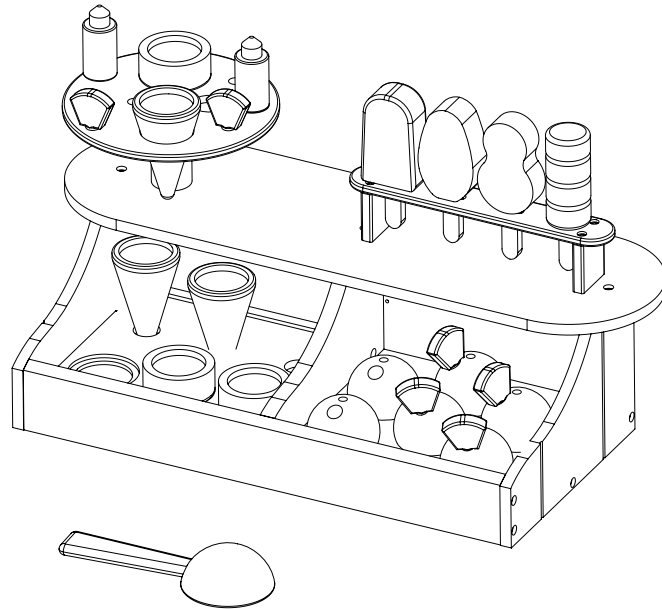

gltc.co.uk

Lolly & Scoop Ice Cream Shop L4175



Assembly Difficulty



easy - medium - hard



one-person job



07/11/2016

Thank you for shopping with GLTC, we hope you enjoy having this product in your home.

We know assembling furniture, toys or accessories is not everyone's favourite way to spend their time, so we've tried to make assembling this item as quick and painless as possible.

Hopefully our efforts will have been worthwhile and you'll sail through the whole process. But if it all feels a bit too much like hard work, then we do have an assembly company we can recommend: the Flatpack Construction Company offers a nationwide service and can be contacted on **0843 289 4951** or **www.flatpackconstruction.co.uk**.

A few important pointers before you start:

- Please read the instructions right through before you start, and check that all the components have been included in the pack; we find separating all the hardware into piles makes it easier to be sure that everything is present and correct.
- Make sure you have the right tools. Allen keys are provided if required, but screw drivers and other tools are not. You'll find details of the tools you need at the beginning of the instructions.
- Do not throw away any packing materials until assembly is complete, just in case you accidentally discard smaller parts or hardware.

Safety Warnings:

- Please read these instructions carefully before assembly.
- Adult assembly required.
- Unassembled product contains small parts which may present a choking hazard.
- Not suitable for children under 3 years due to small parts that may become detached and present a choking hazard.
- Children should be kept away from the product during assembly to avoid any possible risk of injury.
- Assemble and use on a flat and level surface.
- **DO NOT** use power tools in the assembly of this product as there is a risk of over-tightening and consequently splitting of the wood.
- Check item regularly for signs of damage which may make the product unsafe.
- Check all fixtures and fittings regularly and tighten as necessary.
- Complies to the European Toy Safety Directive.
- **DO NOT** use this item if any components are missing or damaged.
- Please retain these instructions for future reference.

Customer Service:

- If you find that any components are missing or damaged, please do not begin assembly and do not use the item. Please contact GLTC Customer Services on **0344 848 6000** immediately.
- We do stock spare hardware packs at our warehouse, so we should be able to send you a replacement pack immediately if required.

Product Care:

- Wipe clean using a soft damp cloth followed by a dry cloth.
- Do **NOT** use cleaning products which contain ammonia, solvents or abrasive material.
- Do **NOT** expose the item to extremes of heat and humidity.









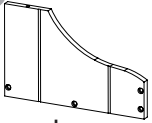

Could we do better?

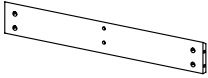
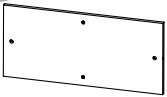
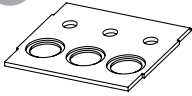
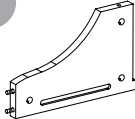
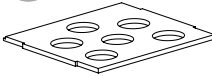
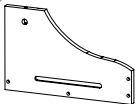

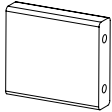
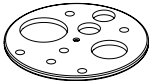

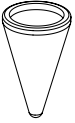
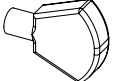

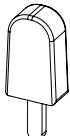
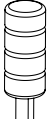
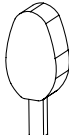
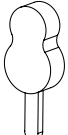
If there is anything you think could be improved in these instructions or in the assembly of this product we'd be grateful if you could let us know; we'll pass any helpful hints and tips on to other customers via our website and update the instructions.

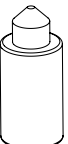
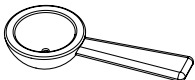
All you need to do is drop us a line at **instructions@gltc.co.uk**

Thank you

Component Check List

A  1x	B  1x	C  1x	D  1x
E  1x	F  1x	G  1x	H  1x
I  1x	J  1x	K  1x	L  2x
M  1x	N  1x		
 3x	 6x	 3x	 1x
 1x	 1x	 1x	 6x
 2x	 1x		

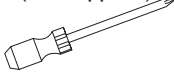
#1  13x Barrel Nuts 7mm dia	#2  13x Barrel Nut Bolts 40mmL	#3  9x Medium Screws 21mmL	#4  1x Cylinder Screw 29mmL
#6  1x Platform Screw 24mmL	#7  1x Washer 12mm dia	You will need (not supplied)  Phillips Head Screwdriver	

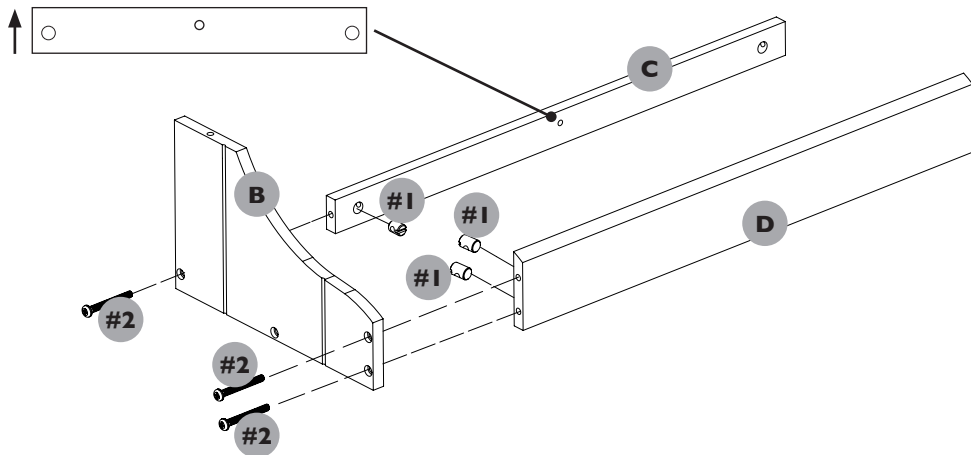

Hardware for Step 1:



3x #1 barrel nuts



3x #2 barrel nut bolts

STEP 1:

Attach panel B to panels C and D using 3x barrel nuts and bolts.

When attaching panel C to panel D, ensure the small hole in the middle of the panel is nearer the top surface. You will need this for step 3.

Hardware for Step 2:



1x #1 barrel nuts



1x #2 barrel nut bolts

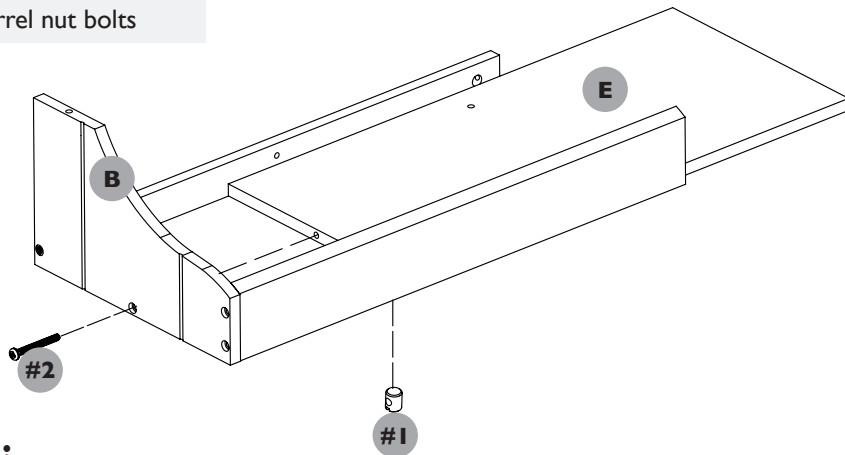

STEP 2:

Now attach the base panel (E) to panel B using 1x barrel nut and bolt.

Hardware for Step 3:



2x #1 barrel nuts



2x #2 barrel nut bolts



1x #3 2.1mmL screw

STEP 3:

Slot panel F into the slots on panel B and G. Now secure panel G to panel E using 2x barrel nuts and bolts.

Now secure panel G to panel C using 1x screw (#3).

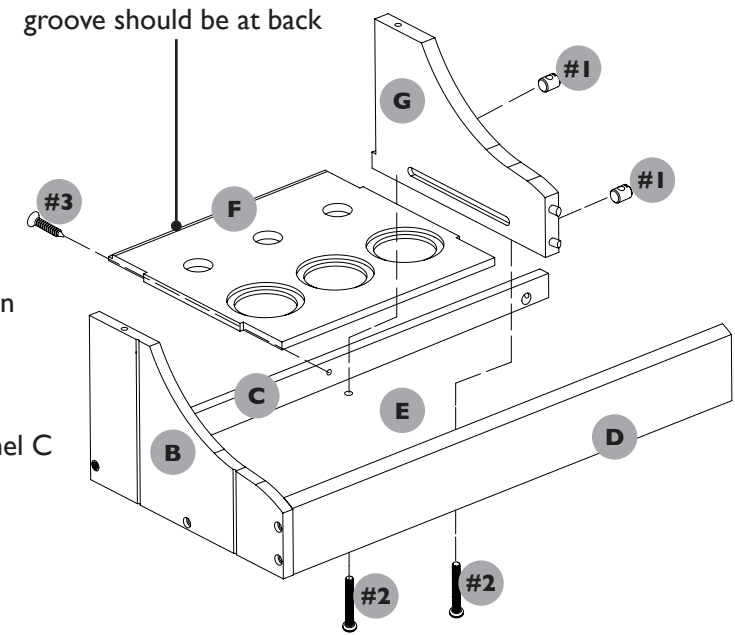

Hardware for Step 2:



4x #1 barrel nuts

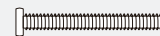

4x #2 barrel nut bolts



STEP 4:

Loosely attach panel I to panels D and C using 4x barrel nuts and bolts. Now slot panel H between panels G and I.

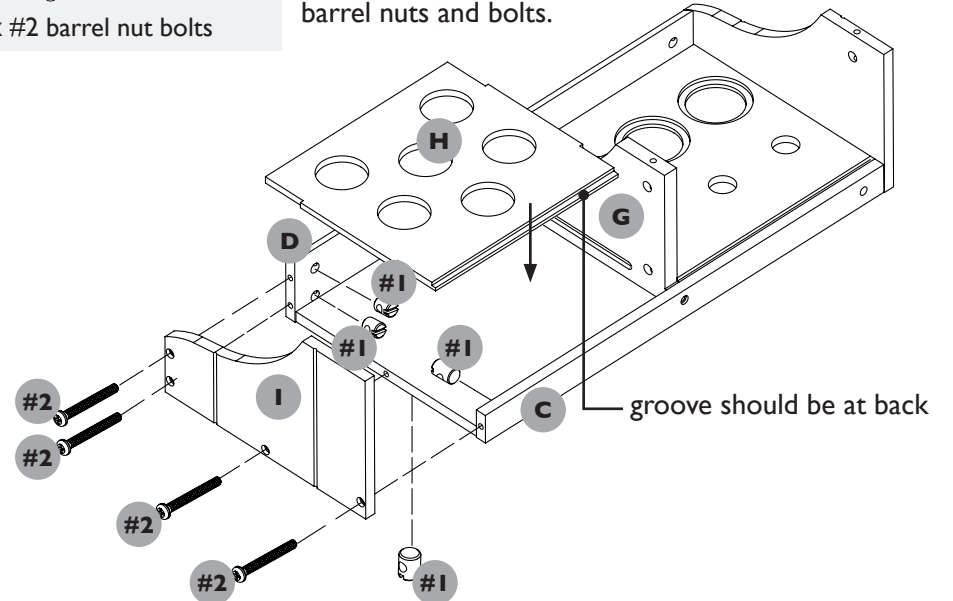
With panel H now in position you can fully tighten the barrel nuts and bolts.



Hardware for Step 5:

-  1x #4 29mmL screw
-  4x #3 21mmL screws

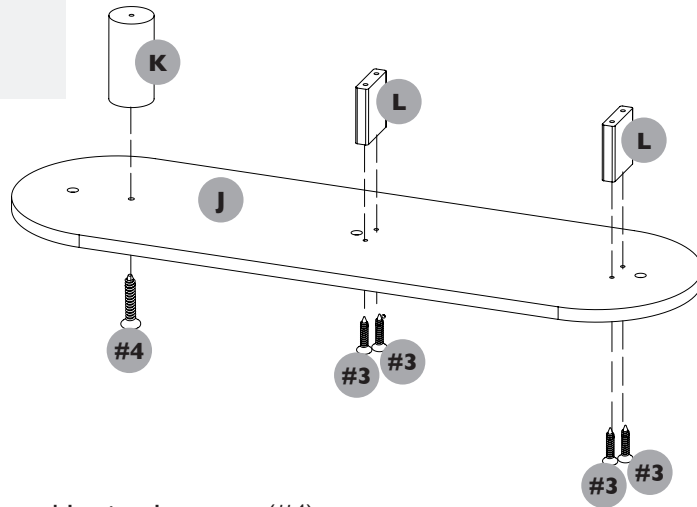

STEP 5:

Attach cylinder K to panel J using 1x screw (#4).
Attach panels L to panel J using 4x screws (#3).

Hardware for Step 6:

-  3x #1 barrel nuts
-  3x #2 barrel nut bolts



STEP 6:

Loosely attach the top assembly to the completed base assembly using 3x barrel nuts and bolts.

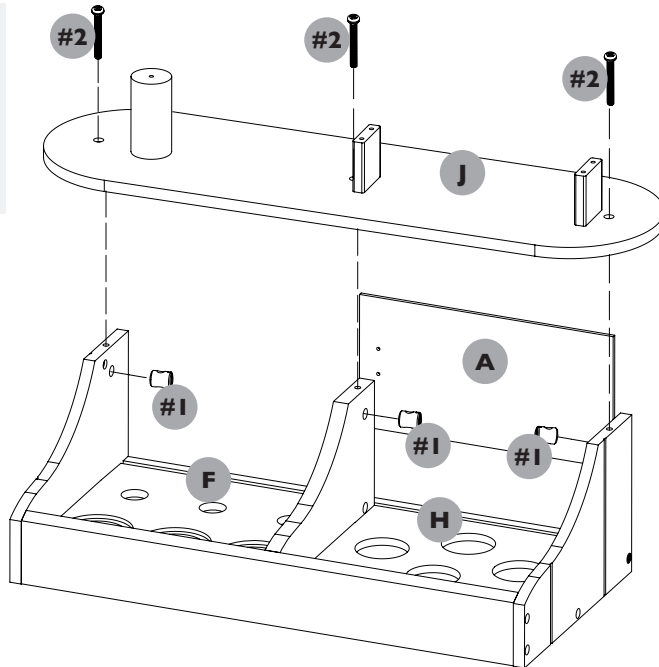
Now carefully place sliding door in the grooves between panels J and F/H. With the door in place, now fully tighten the the barrel nuts and bolts.



Hardware for Step 7:

-  1x #6 24mmL screw
-  4x #3 21mmL screws
-  1x #7 12mm dia

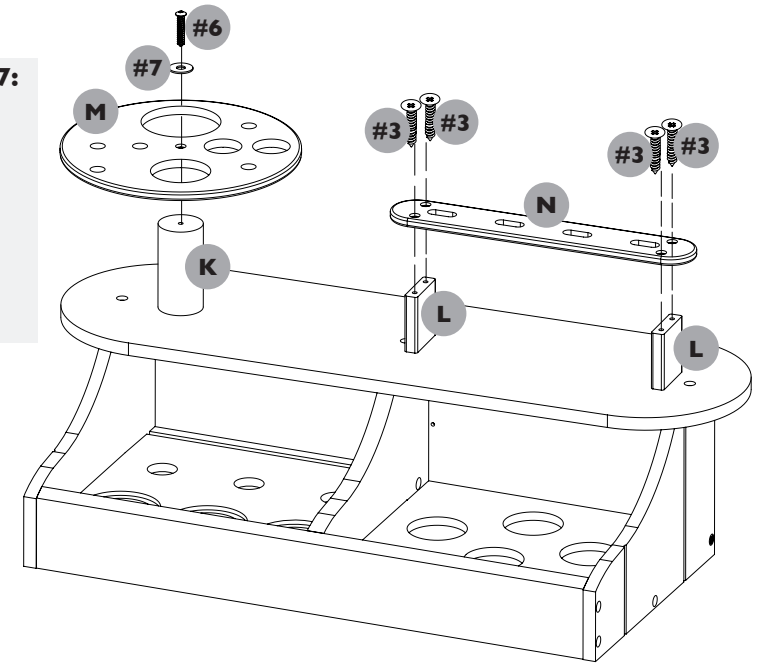

STEP 7:

Secure the top section (M) to the cylinder (K) using 1x screw (#6) and washer (#7). Now secure the lolly stand (N) to pieces (L) using 4x screws (#3).

The assembly is now complete.

