

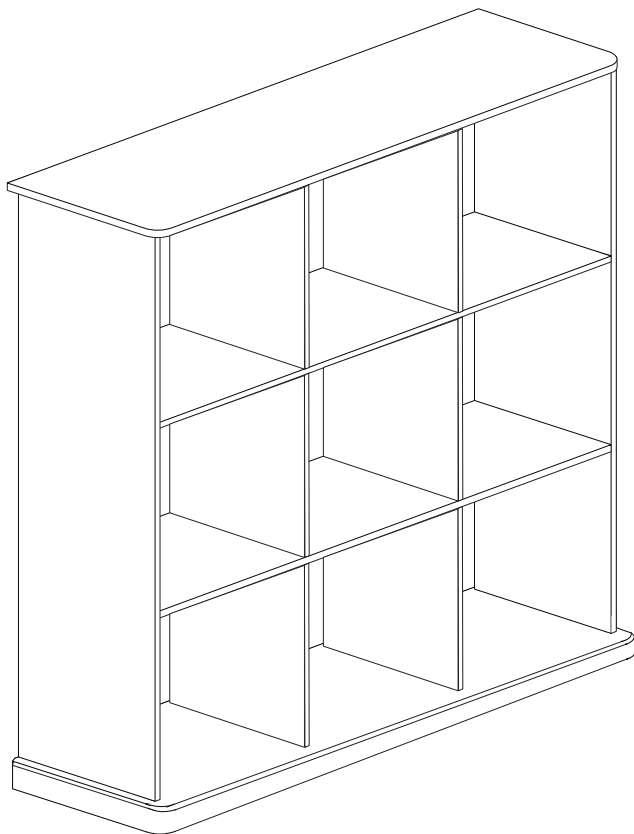

www.gltc.co.uk

Abbeville Storage - Nine Cube Unit L1599



Assembly Difficulty



easy - medium - hard



two-person job

V5

31/03/2023

Thank you for shopping with GLTC, we hope you enjoy having this product in your home.

We know assembling furniture, toys or accessories is not everyone's favourite way to spend their time, so we've tried to make assembling this item as quick and painless as possible.

Hopefully our efforts will have been worthwhile and you'll sail through the whole process.

A few important pointers before you start:

- Please read the instructions right through before you start, and check that all the components have been included in the pack; we find separating all the hardware into piles makes it easier to be sure that everything is present and correct.
- Make sure you have the right tools. Allen keys are provided if required, but screw drivers and other tools are not. You'll find details of the tools you need at the beginning of the instructions.
- Do not throw away any packing materials until assembly is complete, just in case you accidentally discard smaller parts or hardware.

SAFETY WARNINGS!

- Please read these instructions carefully before assembly.
- Assembly to be carried out by a competent adult only.
- Children should be kept away from the product during assembly to avoid any possible risk of injury.
- Assemble and use on a flat and level surface.
- DO NOT use power tools in the assembly of this product as there is a risk of over-tightening and consequently splitting of the wood.
- Check all fixtures and fittings regularly and tighten as necessary.
- DO NOT use this item if any components are missing or damaged.
- PLEASE RETAIN THESE INSTRUCTIONS FOR FUTURE REFERENCE.
- **WARNING: FURNITURE TIPPING RISK - PLEASE READ CAREFULLY**
- To avoid possible injury from tipping - DO NOT allow children to sit, step or climb on the product.
- Serious or fatal crushing injuries can occur from furniture tipping over. In order to prevent overturning, ensure you secure this furniture product to the wall before you use it, using the anti-tip kit device provided. If you have not yet received an anti-tip kit with your product please contact customer services. You will need to source suitable fixings for your wall. If in doubt, please consult a qualified trades person.
- Attention! This kit acts as a deterrent and cannot replace adult supervision. Never leave any young child unattended.

Product care:

Wipe clean using a soft damp cloth followed by a dry cloth.

Do NOT use cleaning products which contain ammonia, solvents or abrasive material.

Do NOT expose the item to extremes of heat and humidity.

Customer Service:

Should you have any queries regarding your product, missing parts or information and need help please follow the guidance below. For gltc.co.uk orders contact GLTC Customer Services on 0344 848 6000. For all other orders please contact your retailer.

Thank you for shopping with GLTC, we hope you enjoy having this product in your home.

We know assembling furniture, toys or accessories is not everyone's favourite way to spend their time, so we've tried to make assembling this item as quick and painless as possible.

AVERTISSEMENTS!

- Lisez attentivement ces instructions avant l'assemblage.
- L'assemblage peut être uniquement effectué par un adulte compétent.
- Les enfants doivent être tenus à l'écart du produit pendant l'assemblage pour éviter tout risque de blessure.
- Assemblez et utilisez le produit sur une surface plane et horizontale.
- NE PAS utiliser d'outils électriques pour l'assemblage de ce produit, car il existe un risque de serrage excessif et donc de fissure du bois.
- Vérifiez régulièrement toutes les fixations et tous les raccords et resserrez-les si nécessaire.
- NE PAS utiliser cet article si des composants sont manquants ou endommagés.
- CONSERVEZ CES INSTRUCTIONS POUR TOUTE RÉFÉRENCE ULTÉRIEURE.
- **AVERTISSEMENT : RISQUE DE BASCULEMENT DU MOBILIER - À LIRE ATTENTIVEMENT**
- Pour éviter toute blessure due à un basculement, NE laissez PAS les enfants s'asseoir, marcher ou monter sur le produit.
- Le basculement d'un meuble peut entraîner des blessures graves, voire mortelles, par écrasement. Afin d'éviter tout basculement, veillez à fixer ce meuble au mur avant de l'utiliser, à l'aide du kit anti-basculement fourni. Si vous n'avez pas encore reçu de kit anti-basculement avec votre produit, contactez le service clientèle. Vous devrez vous procurer des fixations adaptées à votre mur. En cas de doute, consultez un professionnel qualifié.
- Attention ! Ce kit joue un rôle dissuasif et ne peut pas remplacer la surveillance d'un adulte. Ne laissez jamais un enfant en bas âge sans surveillance.

Entretien du produit:

Nettoyez à l'aide d'un chiffon doux et humide, puis d'un chiffon sec.

NE PAS utiliser de produits de nettoyage contenant de l'ammoniac, des solvants ou des abrasifs.

NE PAS exposer l'article à des conditions extrêmes de chaleur et d'humidité.

Service clientèle:

Pour toute question concernant votre produit, des pièces ou informations manquantes, ou si vous avez besoin d'aide, suivez la procédure ci-dessous. Pour les commandes gltc.co.uk, contactez le service clientèle GLTC au 0344 848 6000. Pour toute autre commande, contactez votre revendeur.

Merci d'avoir fait vos achats chez GLTC. Nous espérons que vous apprécierez ce produit chez vous.

Nous savons que l'assemblage de meubles, de jouets ou d'accessoires n'est pas l'activité la plus agréable. C'est pourquoi nous avons essayé de rendre l'assemblage de cet article aussi rapide et facile que possible.

WARNHINWEISE!

- Bitte lesen Sie diese Anleitung vor dem Zusammenbau sorgfältig durch.
- Der Zusammenbau darf nur durch einen kompetenten Erwachsenen erfolgen.
- Kinder sollten während des Zusammenbaus von dem Produkt ferngehalten werden, um mögliche Verletzungen zu vermeiden.
- Auf einer ebenen Fläche zusammenbauen und verwenden.
- Verwenden Sie bei dem Zusammenbau dieses Produkts KEINE Elektrowerkzeuge, da das Holz gegebenenfalls zu fest angezogen werden und dadurch splintern könnte.
- Überprüfen Sie regelmäßig alle Einbauten und Zubehör, und ziehen Sie sie bei Bedarf fest.
- Verwenden Sie dieses Produkt NICHT, wenn Teile davon fehlen oder beschädigt sind.
- BEWAHREN SIE DIESE ANLEITUNG BITTE ZUR SPÄTEREN REFERENZ SORGFÄLTIG AUF.
- **WARNUNG: MÖBELKIPPGEFAHR – BITTE SORGFÄLTIG LESEN**
- Zur Vermeidung möglicher Verletzungen durch Umkippen dürfen Kinder AUF KEINEN FALL auf das Produkt klettern, darauf sitzen oder stehen.
- Das Umkippen von Möbeln kann schwere bis tödliche Quetschverletzungen hervorrufen. Um ein Umkippen zu vermeiden, befestigen Sie dieses Möbelstück vor der Verwendung mit der mitgelieferten Kipp-Schutzvorrichtung an der Wand. Wenn bei Ihrem Produkt noch keine Kipp-Schutzvorrichtung enthalten war, wenden Sie sich bitte an den Kundendienst. Es ist erforderlich, dass Sie geeignete Befestigungen für Ihre Wand beschaffen. Im Zweifelsfall wenden Sie sich bitte an einen qualifizierten Händler.
- Achtung! Diese Vorrichtung dient zur Abschreckung und ersetzt nicht die Aufsicht eines Erwachsenen. Lassen Sie kleine Kinder niemals unbeaufsichtigt.

Produktpflege:

Zum Reinigen mit einem weichen, feuchten Tuch und anschließend mit einem trockenen Tuch abwischen.

Verwenden Sie KEINE Reinigungsprodukte, die Ammoniak, Lösungsmittel oder Scheuermittel enthalten.

Setzen Sie das Produkt NICHT extrem hoher Temperatur oder Feuchtigkeit aus.

Kundendienst:

Sollten Sie Fragen zu Ihrem Produkt oder fehlenden Teilen haben und Hilfe benötigen, folgen Sie bitte den unten stehenden Anweisungen. Bei Bestellungen von gltc.co.uk wenden Sie sich bitte an den GLTC-Kundendienst unter +4420 (0) 344 848 6000. Für alle sonstigen Bestellungen wenden Sie sich bitte an Ihren Händler.

Vielen Dank, dass Sie sich für GLTC entschieden haben. Wir hoffen, dass Ihnen dieses Produkt viel Freude bereitet.

Wir wissen, dass nicht jeder seine Zeit gern mit dem Zusammenbau von Möbeln, Spielzeug oder Zubehör verbringt. Daher haben wir uns bemüht, die Montage dieses Produkt so schnell und einfach wie möglich zu gestalten.

ADVERTENCIAS!

- Lea atentamente estas instrucciones antes de montarlo.
- El montaje debe ser realizado únicamente por un adulto competente.
- Los niños deben mantenerse alejados del producto durante el montaje para evitar cualquier posible riesgo de lesiones.
- El producto debe montarse y usarse sobre una superficie plana y nivelada.
- NO utilice herramientas eléctricas montar el producto, ya que existe el riesgo de que se apriete en exceso y, por consiguiente, se parta la madera.
- Compruebe todas las fijaciones y conexiones regularmente y apriételas si es necesario.
- NO utilice este producto si falta algún componente o está dañado.
- CONSERVE ESTAS INSTRUCCIONES PARA CONSULTARLAS EN EL FUTURO.
- **ADVERTENCIA: EXISTE EL RIESGO DE QUE SE VUELQUE EL MUEBLE, LEA DETENIDAMENTE**
- Para evitar posibles lesiones por vuelcos, NO permita que los niños se sienten, se suban o se pongan de pie sobre el producto.
- El vuelco de los muebles puede provocar lesiones graves o mortales por aplastamiento. Para evitar que vuelque, asegúrese de fijar el producto a la pared antes de utilizarlo mediante el kit antivuelco suministrado. Si no ha recibido un kit antivuelco con su producto, póngase en contacto con el servicio de atención al cliente. Tendrá que conseguir unas fijaciones adecuadas para su pared. En caso de duda, consulte a una persona cualificada.
- Atención: Este kit tiene una finalidad preventiva y no pretende reemplazar la supervisión de un adulto. No desvíe nunca su atención de los niños pequeños.

Cuidado del producto:

Limpie el producto con un paño suave y húmedo seguido de un paño seco.

NO utilice productos de limpieza que contengan amoníaco, disolventes o material abrasivo.

NO exponga el producto a temperaturas extremas de calor y humedad.







Servicio de atención al cliente:

Si tiene alguna pregunta sobre el producto, le faltan piezas o información y necesita ayuda, siga las instrucciones que se indican a continuación. Para los pedidos de gltc.co.uk, póngase en contacto con el servicio de atención al cliente de GLTC llamando al 0344 848 6000. Para el resto de pedidos, póngase en contacto con su distribuidor.

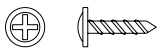
Gracias por comprar en GLTC. Esperamos que disfrute de su producto.

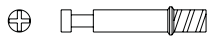
No a todo el mundo le gusta montar muebles, juguetes o accesorios. Por eso, hemos intentado hacer que el montaje de este producto sea lo más rápido y sencillo posible.

Component Check List

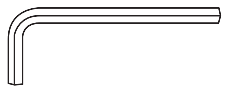
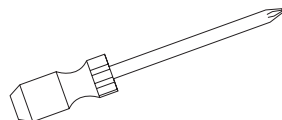
<p>#1</p>  <p>24x Wooden Dowels</p>	<p>#2</p>  <p>22x Back Panel Screws</p>
<p>#3</p>  <p>16x Cam Locks</p>	<p>#4</p>  <p>16x Cam Dowels</p>
<p>#5</p>  <p>8x Barrel Nuts</p>	<p>#6</p>  <p>8x Bolts</p>
<p>#7</p>  <p>1x Anti-Tip Kit</p>	 <p>1x Allen Key</p>
<p>You will need (not supplied)</p>  <p>Phillips Head Screwdriver</p>	

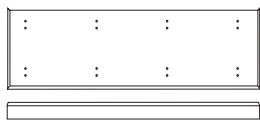
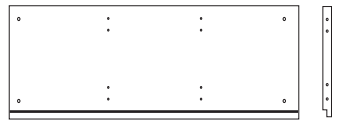
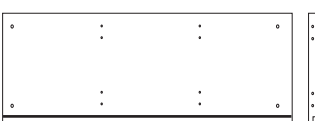
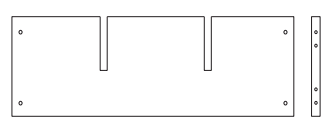
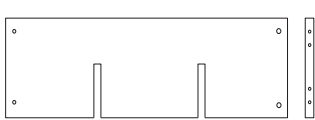
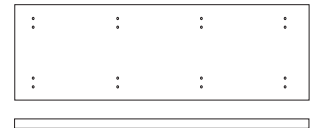
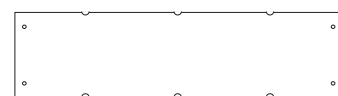
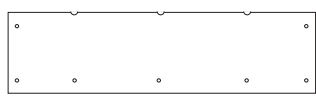
<p>A</p>  <p>1x Base Panel</p>	<p>B</p>  <p>1x Side Panel</p>
<p>C</p>  <p>1x Side Panel</p>	<p>D</p>  <p>2x Horizontal Shelves</p>
<p>E</p>  <p>2x Vertical Divider Panels</p>	<p>F</p>  <p>1x Top Panel</p>
<p>G</p>  <p>1x Mid Back Panels</p>	<p>H</p>  <p>2x Outer Back Panels</p>

STEP 1:

Working on a protective surface like a carpet or rug, you will be building this unit with the front facing up.

Take note of the panel orientation guidance in the steps.

With the help of a second person, take 2x vertical divider panels E and hold in a parallel formation with the slots facing up. The larger drill holes on both of these panels are the 'top' of the unit, smaller holes are the 'base'

Ensure these drill holes are pointing towards the BASE

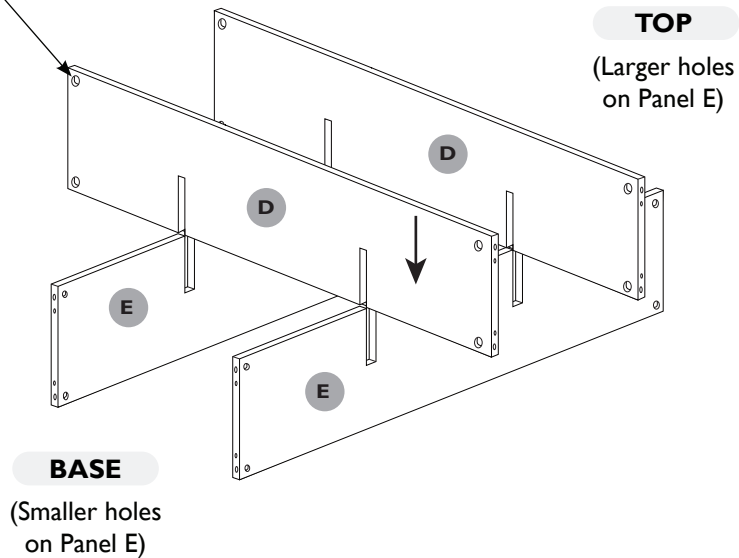

Now slot 2x horizontal shelf panels D into panels E. Make sure the large drill holes of the panels are pointing in the same direction to what will be the base of the unit (smaller holes on panels E).

STEP 2:

Take both side panels B & C and insert 4x cam dowels (#4) and 4x wooden dowels (#1) into EACH panel as shown.

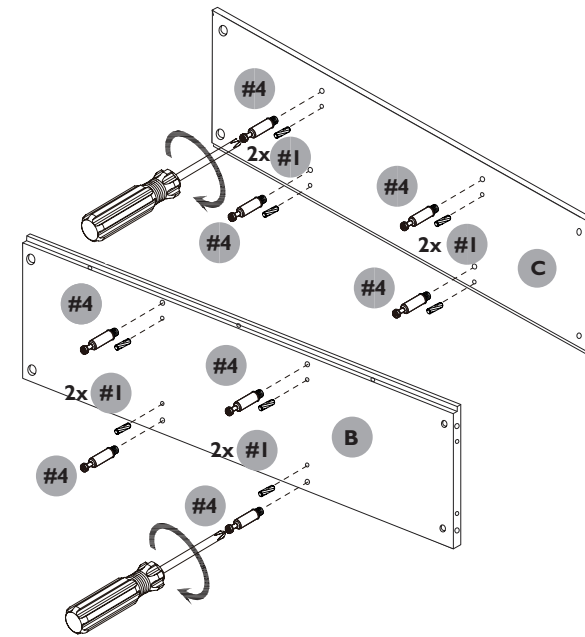
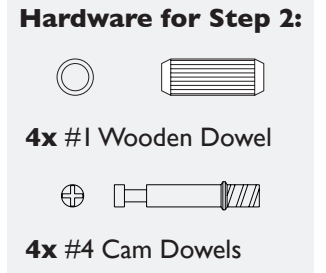

STEP 3:

Take side panel B and orientate so that the grooved edge is facing down & the smaller drill holes are at the base short edge and the larger drill holes are at the top short edge of the panel.

Align the hardware on panel B with the holes on the edges of both panels D and connect to the unit as shown. When in place, insert 2x cam locks (#3) into the large drill holes of BOTH the shelf panels D and turn clockwise to secure.

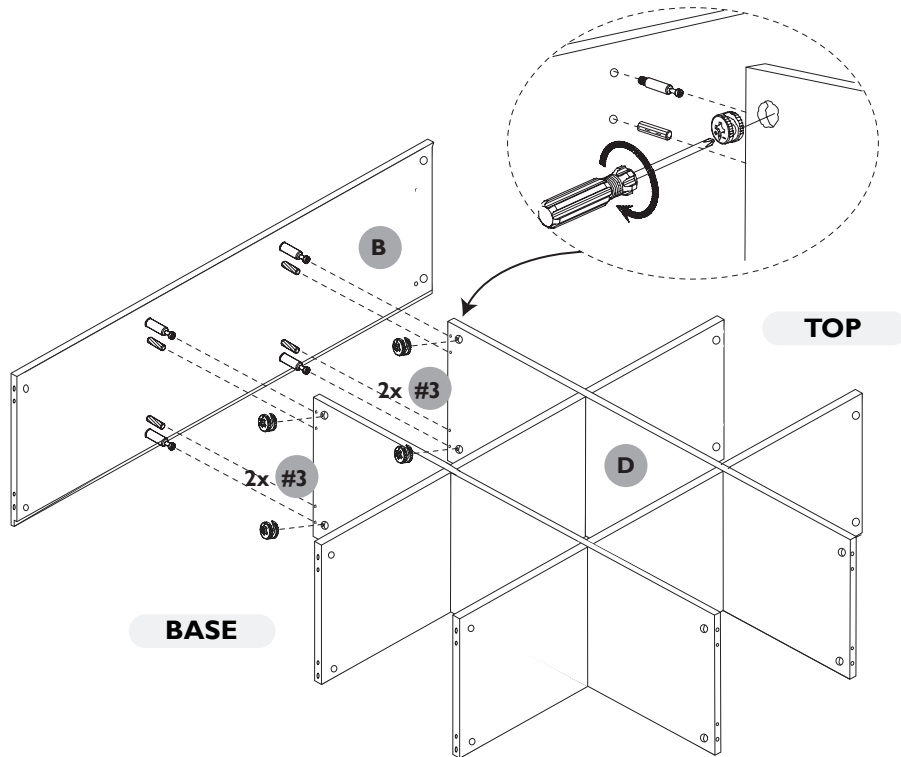

Hardware for Step 3:



4x #3 Cam Locks

STEP 4:

Take side panel C and orientate so that the grooved edge is facing down & the smaller drill holes are at the base short edge and the larger drill holes are at the top short edge of the panel.

Align the hardware on panel C with the holes on the edges of both panels D and connect to the unit as shown. When in place, insert 2x cam locks (#3) into the large drill holes of BOTH the shelf panels D and turn clockwise to secure.

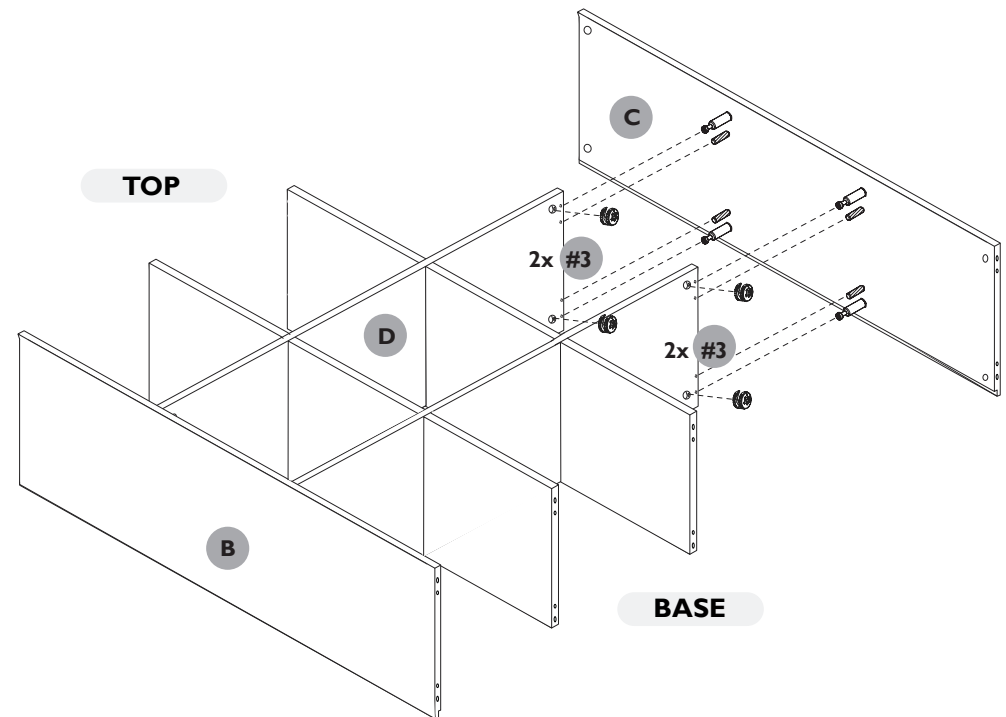

Hardware for Step 4:



4x #3 Cam Locks

STEP 5:

Attach base panel A to the unit.

Start by inserting 8x wooden dowels (#1) into the two inner holes of the open edges of panels B, C, & 2x E. Now insert 8x barrel nuts (#5) into the holes on the sides of panels B, C, & 2x E. Ensure the holes in the nut are pointing towards the edge where the base panel is joining.

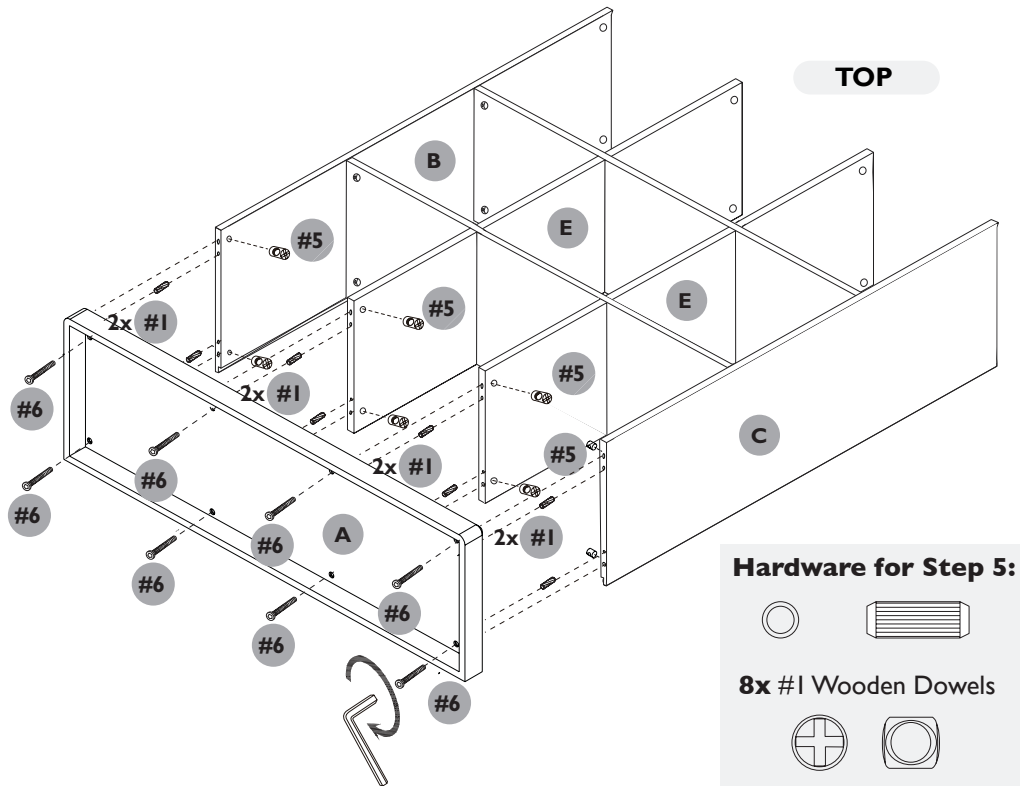

Hardware for Step 5:

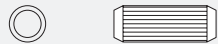

8x #1 Wooden Dowels



8x #5 Barrel Nuts

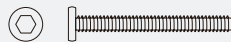

8x #6 Bolts

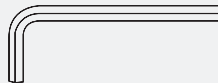

Allen Key

With the grooved edge of the base panel facing down and the rounded corners facing up, align base panel A with the wooden dowels on the built unit and push into place.

Now insert 8x bolts (#6) into the holes as shown. Fully tighten with the allen key provided to secure the base.

STEP 6:

Prepare top panel F by inserting 8x cam dowels (#4) into the outer holes and insert 8x wooden dowels into the inner holes on the panel as shown.

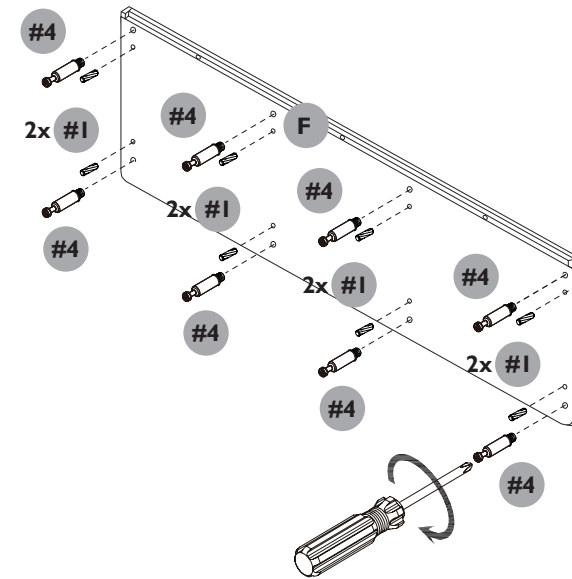

Hardware for Step 6:

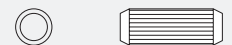

8x #1 Wooden Dowels

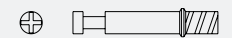

8x #4 Cam Dowels

STEP 7:

Orientate top panel F with the grooved edge facing down and the rounded corners facing up.

Align all the hardware with the corresponding holes on panels B, C & 2xE.

When in place, insert 8x cam locks (#3) into the large drill holes on the vertical panels and turn clockwise to secure.

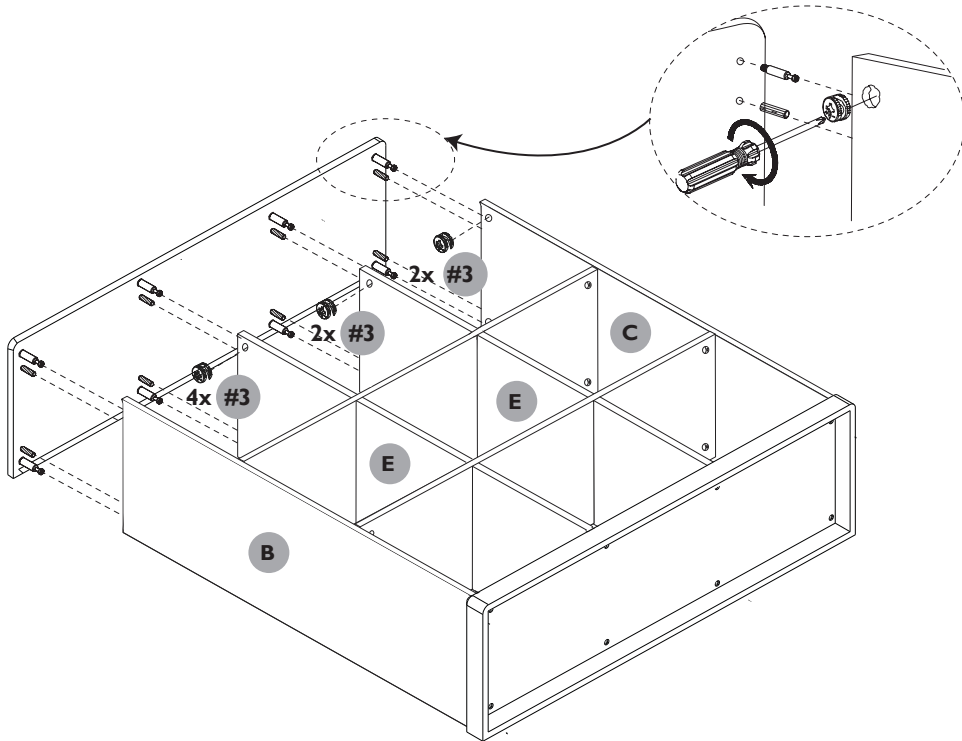

Hardware for Step 7:



8x #3 Cam Locks

STEP 8:

Staying on a carpeted surface, with the help of a 2nd person, carefully lift the unit up on its feet and then lay it down on its front.

Position the back panels G & 2x H in the back edge grooves and align the pilot holes. Fix in place using 22x back panel screws (#2).

Ensure the panels are positioned in the order shown.

Please note that the 2x pilot holes indicated at the top of the unit are to attach anti-tip straps included separately with this item. Please see next step to complete the back panel attachment.

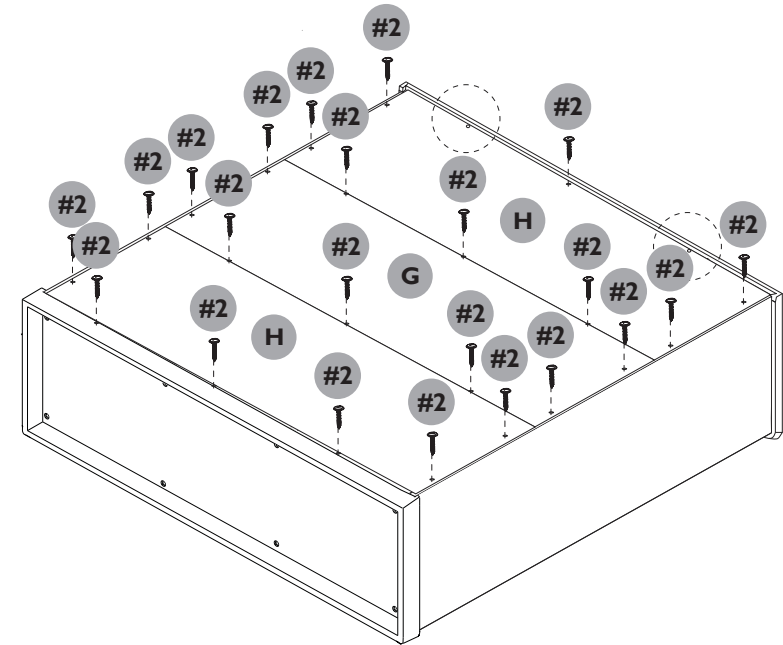

Hardware for Step 8:

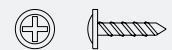

22x #2 Screws

STEP 9:

Finally, open the anti tip kit included with your unit and attach 2 of the brackets to the unit using the screws in the kit in the position shown.

Your unit is now ready to be attached to the wall using hardware suitable for the wall type in your home (not provided). Please see kit instructions for details.

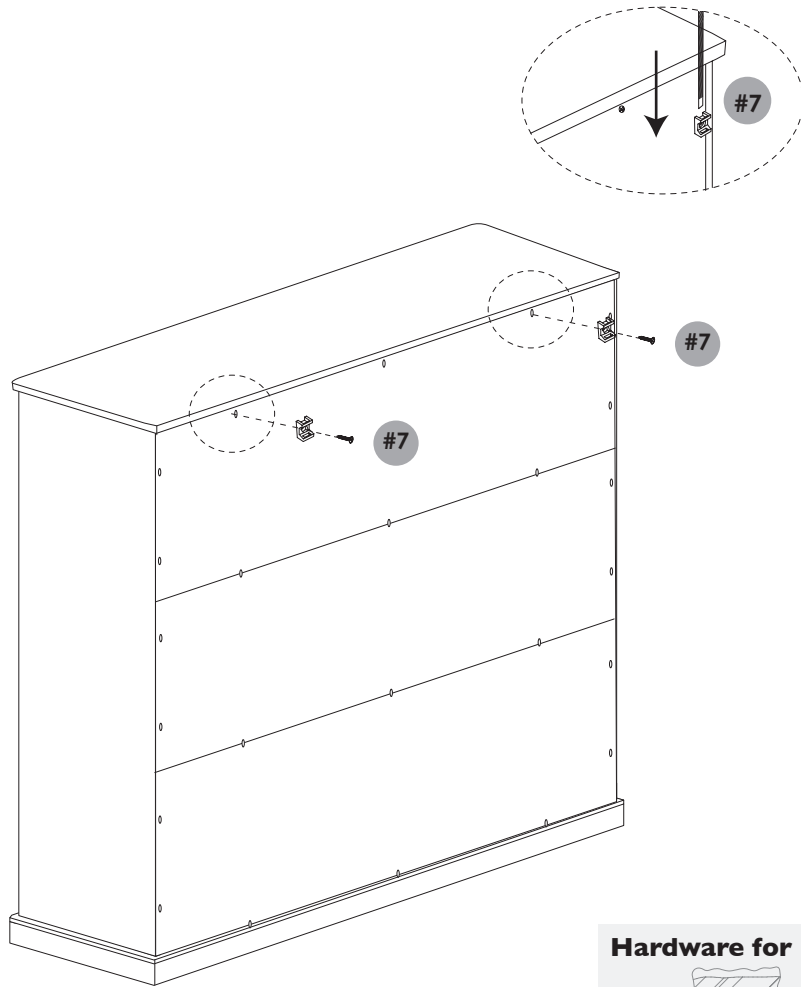

Hardware for Step 9:



1x #7 Anti-Tip Kit

STEP 10:

Your unit is now ready to use.

