

**** SEE OUR WEBSITE FOR STEP BY STEP ASSEMBLY VIDEOS ****













<https://vegepod.com.au/pages/assembly-videos>

Assembly Instructions

Large 2m x 1m



Component Checklist

	Base Container	4
	Side Panel - Lip	12
	Side Joiner - Lip	2
	Side Joiner - No Lip	6
	Corner Connector - Lip	4
	Drain Tray	12
	Rubber Joining Strip	3
	Support Brace	6
	Joining Clip	12
	Plastic bolts & wing-nuts	48
	Cable Ties	24

Assembly

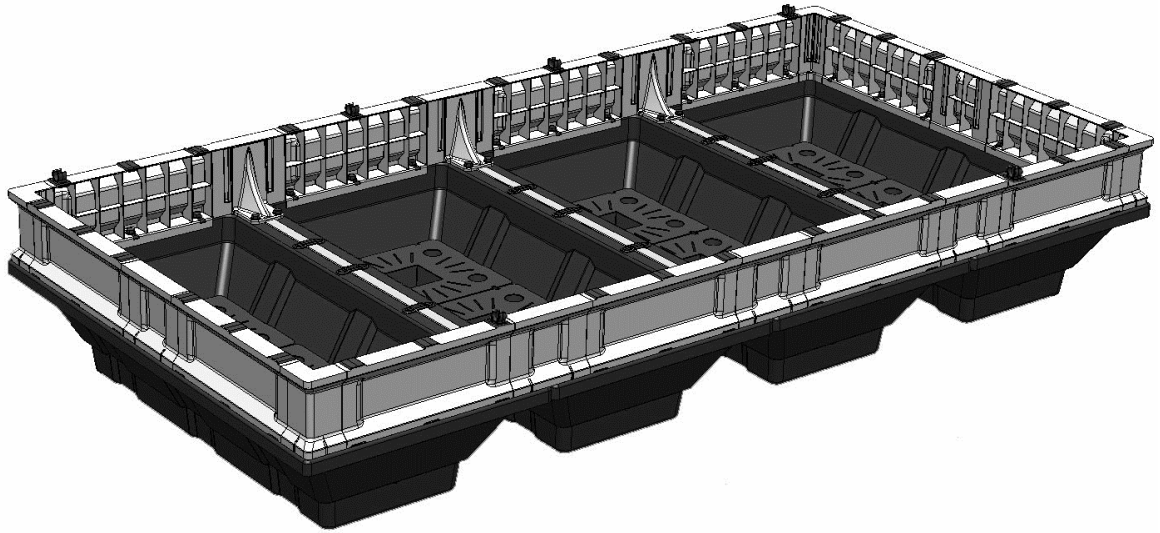

Finished product

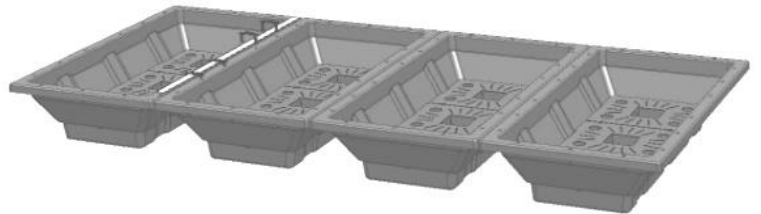

1. Line up base containers side by side.

2. Join Drain Trays together - Lay 3 drain trays face down on level ground and tie together using cable ties provided. Tie each cable tie between small holes at side of drain tray to join together. Turn over drain trays and place in base containers.

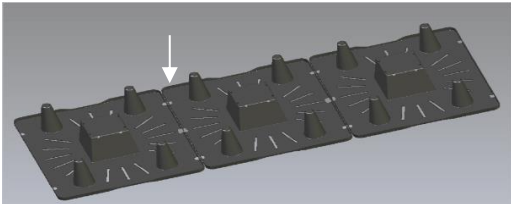

3. Place Rubber Joining Strips between each container and push only 4 Joining Clips into holes so they bridge the rubber strip.

****IMPORTANT** – leave end clips out, just put 4 clips in middle 4 holes.

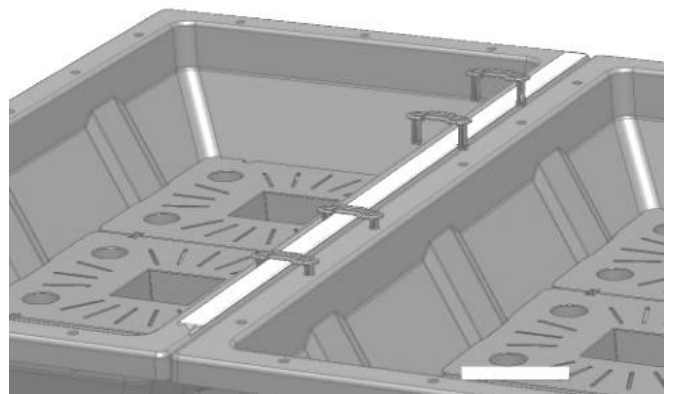

**** Important leave both end sets of holes vacant – only put 4 clips bridging 4 centre sets of holes*

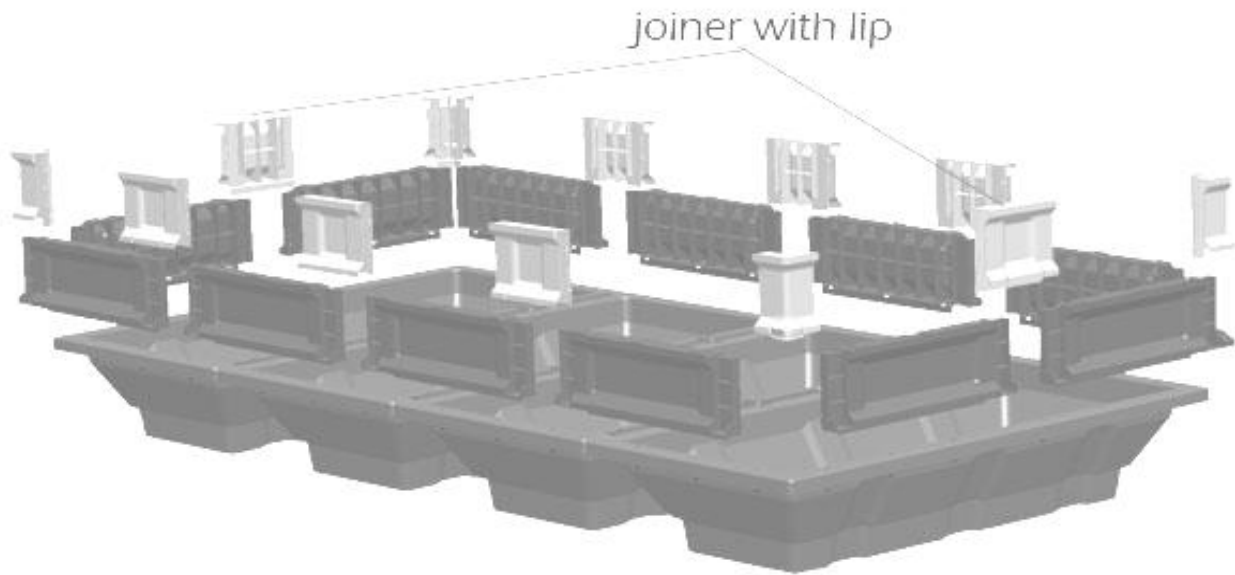

4. Create a perimeter with all of the panels by sliding them together. The joiners with lips go on opposite 2 ends. The joiners with flat bottoms are used to span the joins of the base containers.

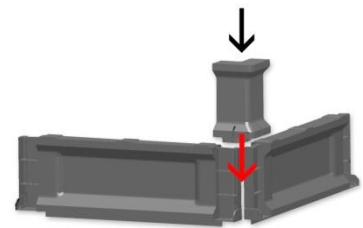

Slide and click panels together.

There is a small RELEASE CLIP if you need to disassemble.

Lift onto 4 joined base containers and ensure top rim is seated with lip on inside of containers.

5. Clip Support Braces into all of the Side Joiners with no lips. Lever the tops of the support braces so the 2 notches in the joiner panel slide into support brace and then swing the bottom down till it clips in. The holes should line up with those on the base containers.
6. Push bolts into all of the holes that join the top rim panels to the base containers. Also, push bolts through the support brace holes.

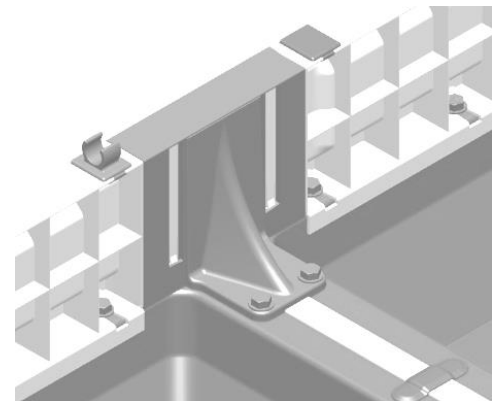

**** Lift rim slightly so bolts drop through easily.**

*** IMPORTANT ***

ENSURE ALL BOLTS ARE INSERTED BEFORE WING-NUTS ARE PUT ON.

7. Tighten wing nuts

Positioning

Sun, sun and more sun is what you are after. The included Vegecover will protect your plants from hot days so find a nice sunny spot.

* Position it before filling with soil as it will be too heavy to move.



Filling

GROWING MEDIUMS

There are several types of growing mediums suitable for the Vegepod. They go by different names in different countries (soil, potting mix, potting soil, compost). What you need is a mix that is suitable for **container** growing and some are even targeted for Vegetable Growing. The good quality mixes often come with fertiliser in them and are mainly sold by the bag from Garden Centers. These quality mixes not only provide superior growth rates but they will last considerably longer than a cheap mix.

*DON'T USE SOIL FROM THE GROUND

The Large Vegepod (2m x 1m) requires 440 litres (16 cuft) of potting soil/mix to fill. It is important to use a **good quality potting mix/soil** preferably one that is aimed at 'Vegetable growing' and suitable for Container Gardens. (stay clear of the cheap mixes). The better-quality mix you buy will mean the longer it will last. Simply pour the potting mix on top of the drain trays filling the wells and fill to the top.

* FILL RIGHT TO THE TOP – The Vegepod self-watering drain trays are designed to provide water to 30cm (11-12) inches of growing medium.



PERLITE

It's not necessary but if you can find perlite it is useful to add to the soil mix. It lightens the soil and also retains water (Vermiculite can be used also) - You can substitute 25% of soil mix for **coarse** grade perlite. Hydroponic stores and some garden centers sell perlite in 100lt (3.5cuft) bags. The smaller 5lt bags are not worth the additional cost.

If you have it place a layer of perlite on top of the trays (approx. 25mm/1in) filling the wicking wells. If you don't have perlite it is fine to use straight potting soil/mix. Mix the rest of the perlite through the mix.

FERTILISING – ongoing maintenance

A good quality potting soil/mix will already contain some form/s of fertiliser so there is no need to do anything initially. After each crop (3-6 months or thereabouts) it is a good idea to turn the soil over and add some fertiliser – the best natural fertilisers are manures, worm compost/tea and garden composts.

The better quality the mix you start with generally means that the mix will last longer – it is ok to use the same potting mix/soil for several years as long as you replenish the nutrients from time to time.

Planting

SEEDS

You can plant seeds directly into the Vegepod soil or you can use a seed raising kit and then transplant them. Seeds take 2-6 weeks longer than planting seedlings/starters from the Garden Centers.

When planting directly into the soil you may need to thin the crops as they sprout to prevent over planting an area.

SEEDLINGS/STARTERS

Planting seedlings or starters directly into the Vegepod is the easiest and fastest way to grow. You can purchase seedlings from Garden Centers and Hardware stores – they usually come in punnets/trays of 6 or 8 plants (sometimes single plants) and are ready to plant.



It is possible to begin harvesting in a matter of weeks when growing from seedlings.

SPACING

Most people over plant when first starting out – this is fine, you will learn what works and what doesn't by trial and error. Tomatoes, zucchini, melons, cucumbers and the likes will often grow out of control as they love the conditions inside the Vegepod – so be prepared if you are planting these.

If you are a beginner then start with leafy greens like lettuce, bok choy, spinach, chard, kale etc. these plants love a high nitrogen mix and grow very quickly in Spring.

Watering

Established plants can locate water much more efficiently than newly planted crops. Seedlings/starters should be watered daily for around 3 minutes (or 1 watering can) until they are established (7 – 10 days) – in cooler weather water every 2nd day.

Once your plants are established then you only need to water once a week. In hotter climates you may need to water every 2nd or 3rd day.

The reservoirs in the Vegepod are extremely efficient and can support plants for up to 6 weeks without watering. Even though the soil is dry to touch on top there is moisture below where the plants require it.

Water for the weather – this means if it is cool and there is some rain around then do not water the Vegepod. If it is hot, windy and dry then water every 2nd day.

Over-watering can inhibit growth rates so if your soil is wet on top hold back on the water. If moss, mildew or fungus appear it is usually a sign that your Vegepod is too wet – leave without water for at least 2 weeks.

The Vegepod has superior water management capabilities and makes excellent use of every drop.

The Vegecovers let some rain in, breaking it into a fine mist so keep in mind when watering.

If you intend going away for 2 weeks or more then it is recommended that you fill the reservoirs before you leave. Water until you see leakage from the overflow holes – if your plants are established then full reservoirs will last 4 weeks without additional water.

1st week – water your seedlings with the mist-spray system every day for the first 7 days (3 to 5mins a day depending on season).

2nd week and beyond – reduce watering dependant on weather. If hot then water 4/5 times a week. If cooler then water once per week. Even if the soil appears dry on top it will be moist down near the reservoir where the plants roots are.

➤ It is possible to leave your plants for up to 4 weeks without watering if they are established and the weather is not too hot.

➤ It is also possible to attach a 24-hour timer to your tap – But remember don't over-water!