

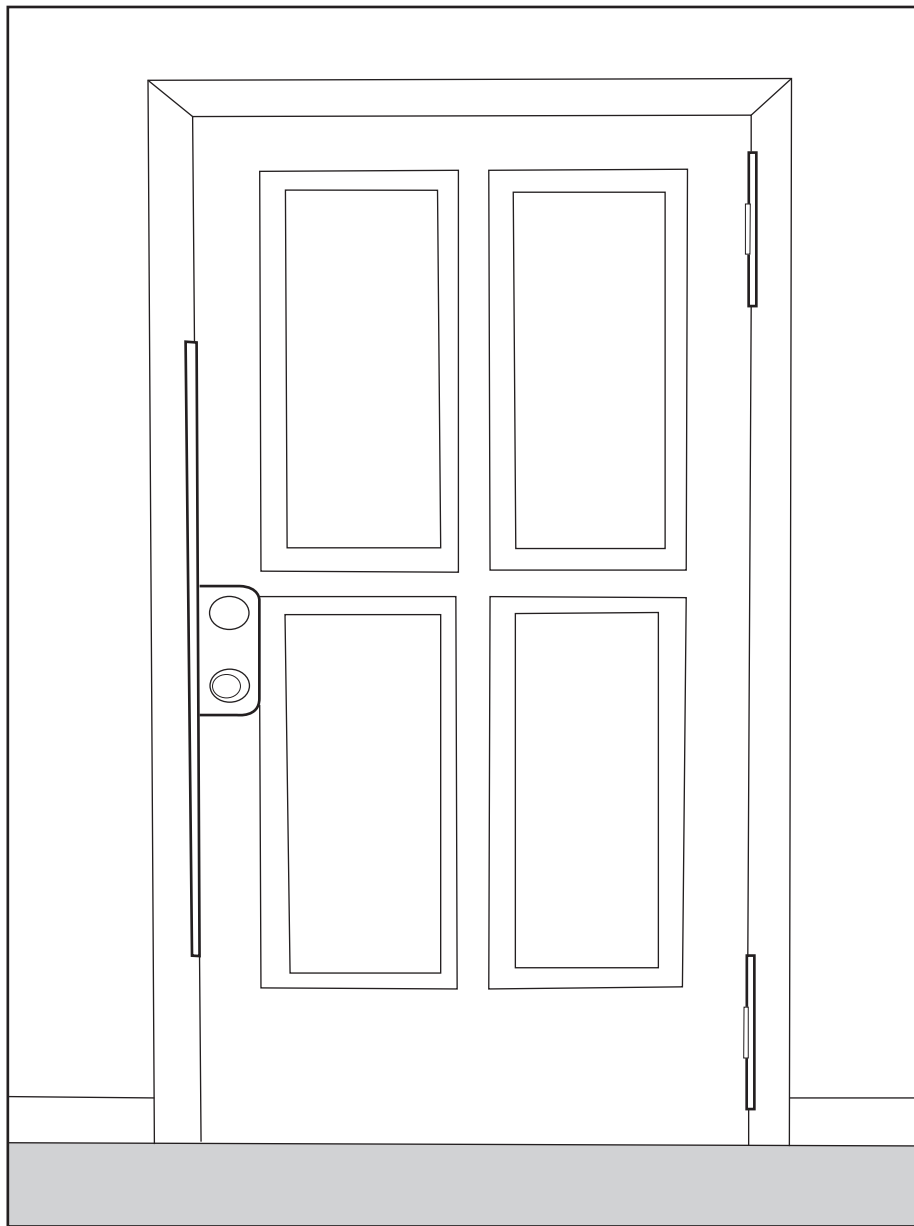

# DOOR SECURITY AND REPAIR KIT

MODEL #S  
SET-SLP-X0552  
SET-STD-X0552  
SET-UNI-X0002  
SET-ULT-X0002



Questions? Call customer service at 1-888-582-2294 or visit [www.djarmor.com](http://www.djarmor.com)

**PACKAGE CONTENTS**

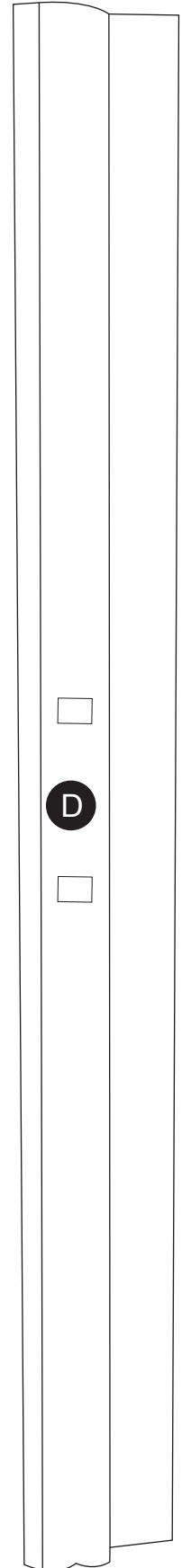
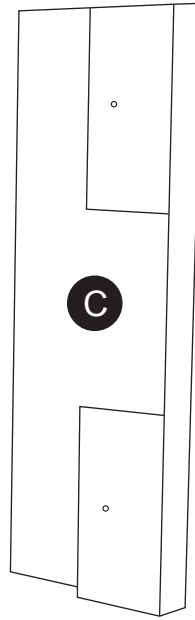
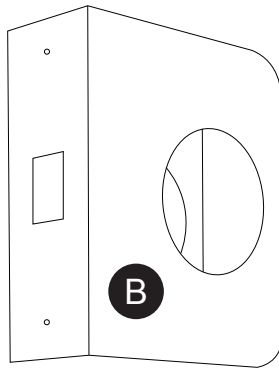
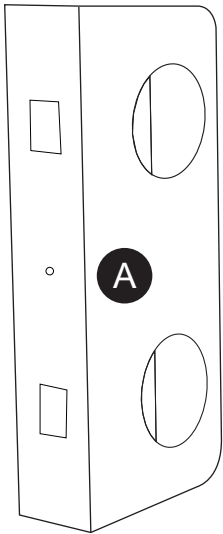

**E**

**F**

**G**

Part	Description	Quantity
A	Door Shield (If Standard Kit was ordered)	1
B	Door Shield (If Universal Kit was ordered)	2
C	Hinge Shield	2
D	Jamb Shield	1
E	3-1/2 in. Screws	19
F	1-5/8 in. Screw (If Standard Kit was ordered)	1
G	1-5/8 in. Screws (If Universal Kit was ordered)	4
H	Set of installation instructions & parts list (not shown)	1



## **SAFETY INFORMATION**

---

### **WARNING**

- The use of work gloves and safety glasses is strongly recommended while installing this product. Wood and metal shaving/splinters can cause serious bodily injury.
- As with all products requiring installation, to reduce the possibility of accidental injury to you or others FOLLOW ALL INSTALLATION INSTRUCTIONS contained herein accurately and carefully.

### **PREPARATION**

---

Before beginning assembly of product, make sure all parts are present. Compare parts with package contents list and diagram above. If any part is missing or damaged, do not attempt to assemble the product. Contact customer service for replacement parts.

Estimated Assembly Time: 1 hour

Tools Required for Assembly:

- Variable speed drill, with screwdriver adapter and bits
- Electric reciprocating saw, with good metal cutting blade
- Small flashlight
- Pry bar
- Carpenter's level
- Claw foot hammer
- 2 Packs of wooden shims
- Phillips screwdriver
- Flathead screwdriver
- Pair of work gloves per person assisting in installation
- Pair of safety glasses per person assisting in installation
- 11/64 in. drill bit

### **PAINTING INSTRUCTIONS**

---

**Note:** It is recommended that Door Jamb Armor components be painted before being installed. They can be touched up as necessary after installation.

1. Using plain steel wool or a very fine emery cloth, gently rough the surface of the piece to be painted. You only want to rough the surface and break the gloss so that your paint will adhere to the surface. Do not totally remove the existing powder coating.
2. Clean the surface with a tack cloth or a cloth with a cleaner on it that will not leave a residue. Rubbing alcohol will work well for this application. You can also use mineral spirits but make sure that whatever you use does not cause an adverse reaction with the powder coating.
3. When components are clean and free of debris, you are ready to paint your pieces.
4. Ensure that all components are completely dry before handling or install them.

## Door Shield Installation

1. Open the door (FIG. DS-01) and remove both the upper and the lower lock assemblies (FIG. DS-02). The bolt and latch assemblies can stay in place. Ensure that components for each lock are kept together and separate from the other assembly parts.

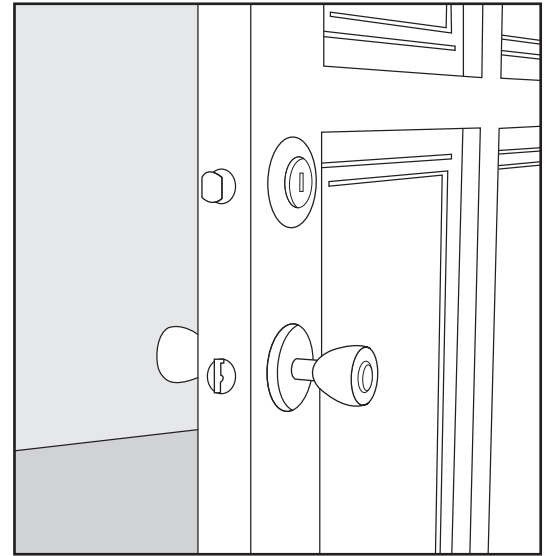

FIG. DS-01

2. Slide the Door Shield onto the door (FIG. DS-03). Position it so that the holes will go over the lock bolts still mounted in the door.

**Important:** If you have a two-piece, Universal Door Shield, install it as indicated in step 3A on page 5 (FIG. DS-03A).

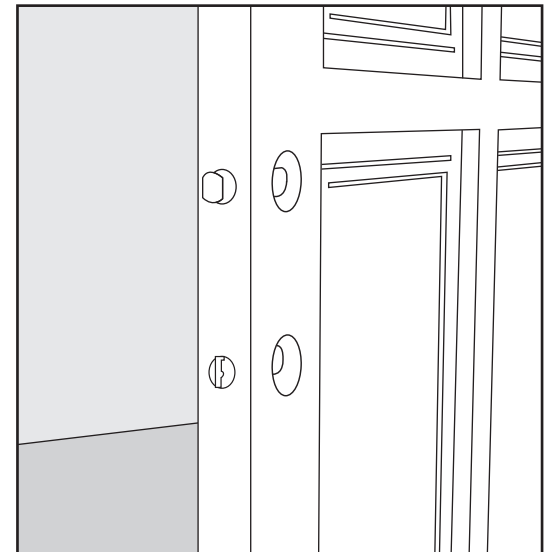

FIG. DS-02

3. Using the supplied 1-5/8 in. screw, secure the Door Shield to the door (FIG. DS-04). This will hold the Door Shield while the locks are installed.

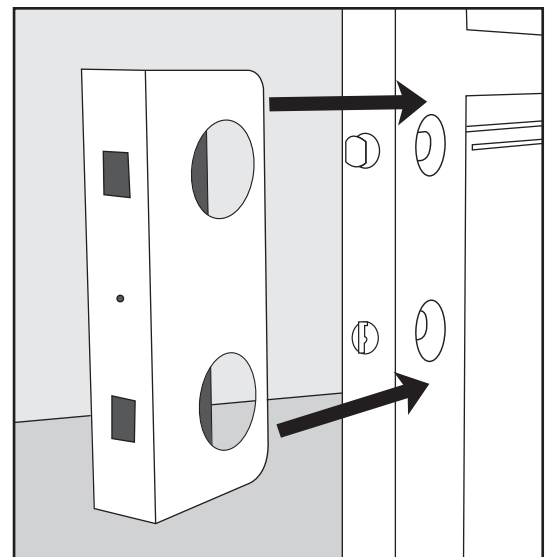

FIG. DS-03

## ASSEMBLY INSTRUCTIONS

3A. If this is a Universal Door Shield, there will be four 1-5/8 in. screws. Using 2 screws for each Door Shield piece, secure the pieces to the door.

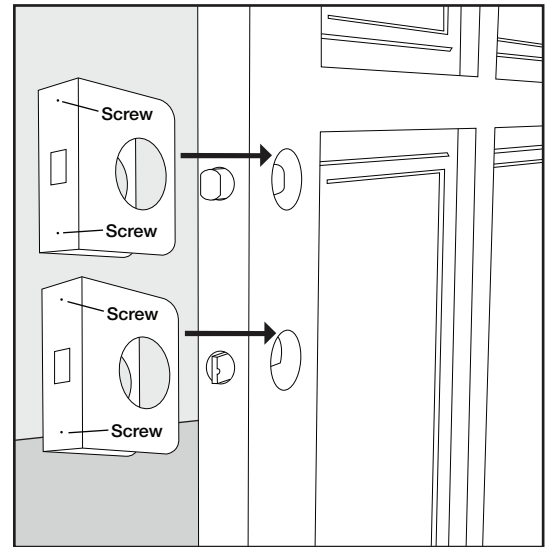

FIG. DS-03A

4. With the Door Shield in place, install the locks, making sure they can be installed with no interference from the Door Shield (FIG. DS-05). Now check the Door Shield, making sure it is level and flush against the door on all sides. **Note:** For Universal applications, this will need to be done for both Door Shield pieces.

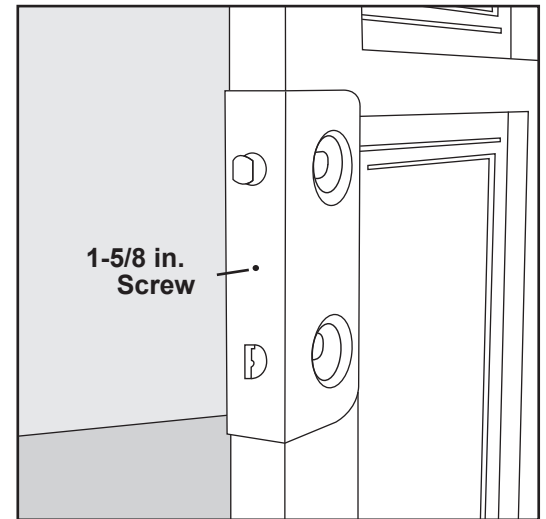

FIG. DS-04

5. Tighten all of the screws in the locks. Verify that the locks can function properly without interference from the Door Shield. If there is interference, adjust the Door Shield until the locks operate freely. If there is no interference, installation is complete.

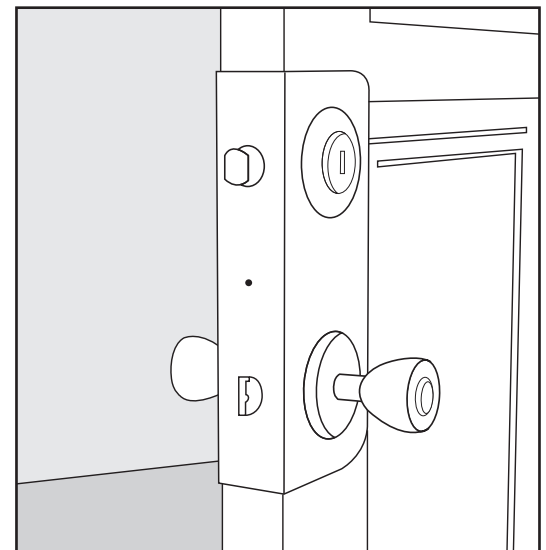

FIG. DS-05

## ASSEMBLY INSTRUCTIONS

**Note:** The door in the illustrations is removed for visual clarity only. It is not necessary to remove the door to install Door Jamb Armor.

### Hinge Shield Installation

1. With the interior moulding removed, locate all points that attach the door jamb to the rough frame as well as all shim placements. **It is very important that these shims stay in their location or are at least replaced similarly.**
2. Starting with the top hinge, remove or cut all bolts that penetrate farther than the door jamb. Then, using a saw with a metal cutting blade, preferably a handheld reciprocating saw, cut any other hardware that is attaching the door jamb to the rough frame and will interfere with the positioning of the Hinge Shield. **It is extremely important that any attaching hardware between the door jamb and the rough frame be cut flush with the door jamb (FIG. HS-01). Failure to do so could hinder proper placement of the Hinge Shield components.**

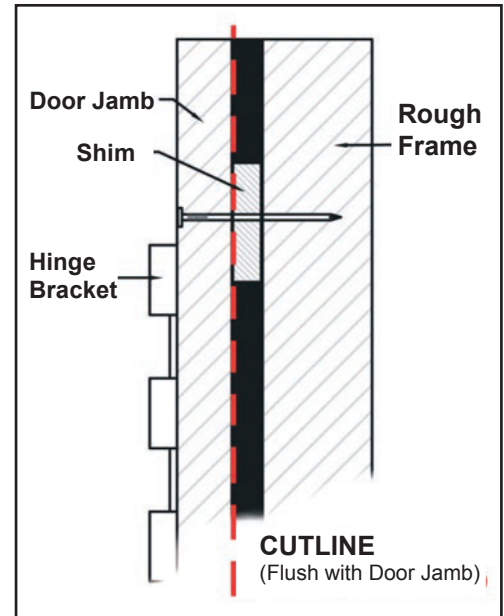

FIG. HS-01

**Note:** It may be necessary to tap the Hinge Shield pieces into place with a soft-faced hammer. The pieces may also rub on the hinges as they move into position.

3. Position the Hinge Shield so that the long leg will go between the door jamb and the rough frame (FIG. HS-02). The short leg will go on the inside of the door jamb with the opening allowing part of the leg to be positioned above and the other to go below the hinge. On the inside of the door jamb, the short leg of the Hinge Shield should fit securely against the door jamb and behind the weather stripping. Use one of the shims to hold the weather stripping out of the way while positioning the Hinge Shield. When placed properly, the edge of the short leg should be hidden by the weather stripping. (See note on FIG. HS-02.)

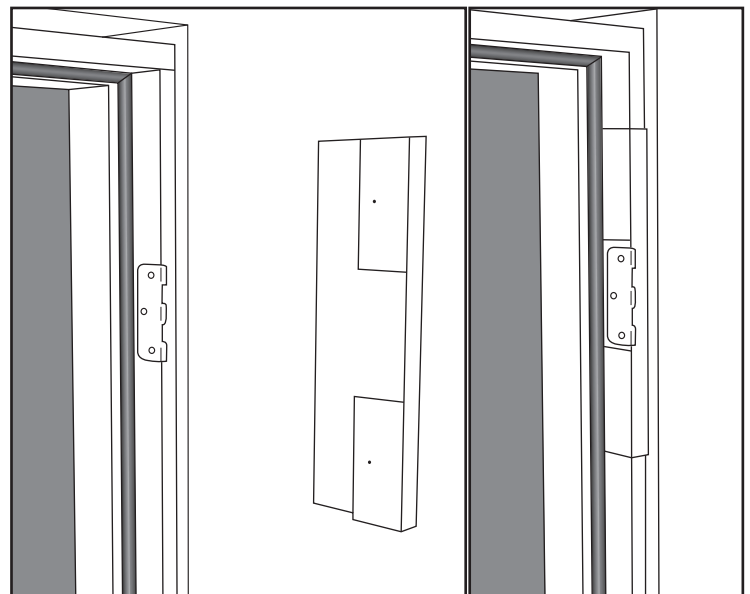

FIG. HS-02

## ASSEMBLY INSTRUCTIONS

4. Shim the Hinge Shield into position and pre-drill the holes for the Hinge Shield as laid out on the diagram with an  $11/64$  in. drill bit. Be sure to drill through the finished frame, the Hinge Shield, the door shims and at least 1 in. into the rough frame. The supplied securing screws are over 3 inches long so pre-drilling should be deep enough to accommodate this length.

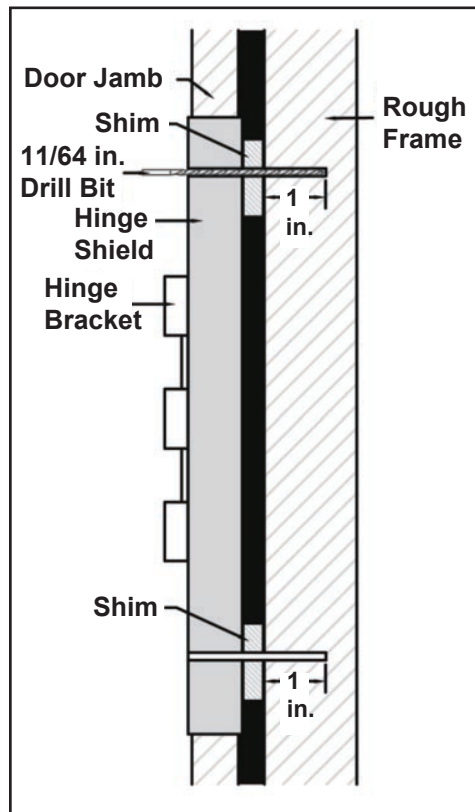

FIG. HS-03

5. Verify that the door and door jamb are still true. If so, secure the door jamb with the Hinge Shield attached to the rough frame with the supplied screws. Drive screws until the heads seat flush against the door jamb. Screw placement is indicated in (FIG. HS-04) with X's and illustrated in (FIG. HS-05).

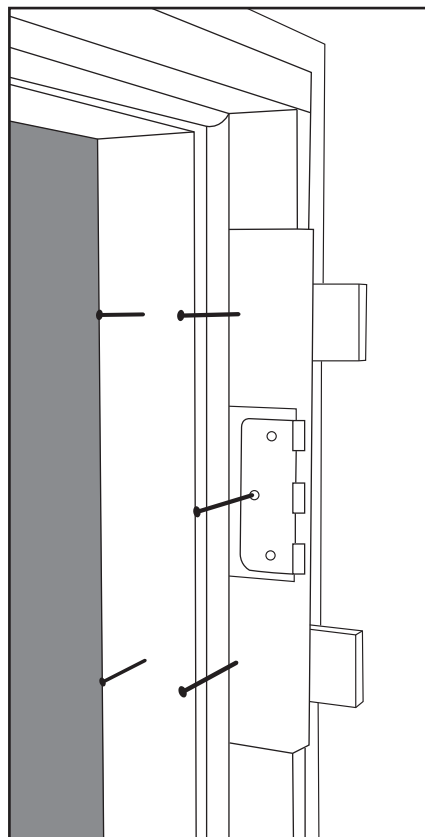

FIG. HS-05

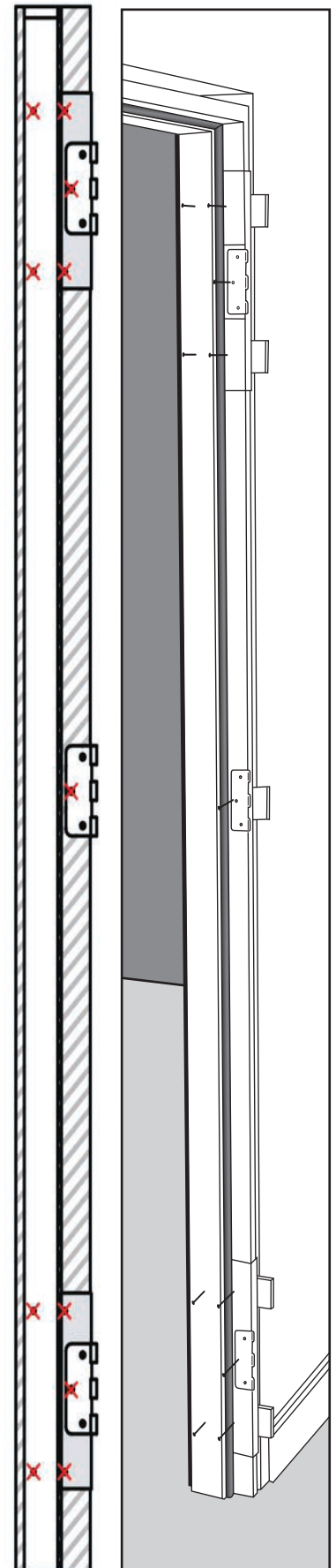

FIG. HS-04

## ASSEMBLY INSTRUCTIONS

6. If the door is not true, take all necessary steps to correct this before proceeding. Once the door is true, secure the door jamb as detailed in step 5 and in (FIG. HS-05).
7. Repeat these steps for all hinges that are to receive a Hinge Shield.
8. Remove one of the screws attaching the middle hinge. Shim this spot between the door jamb and rough frame. Pre-drill this hole and then install one of the 3-1/2 in. screws until it is flush with the door (FIG. HS-04).
9. Once installation is complete, verify that the door is true and operates correctly.
10. Trim all shims flush with the edge of the door jamb and re-install the interior door trim moulding (FIG. HS-06).

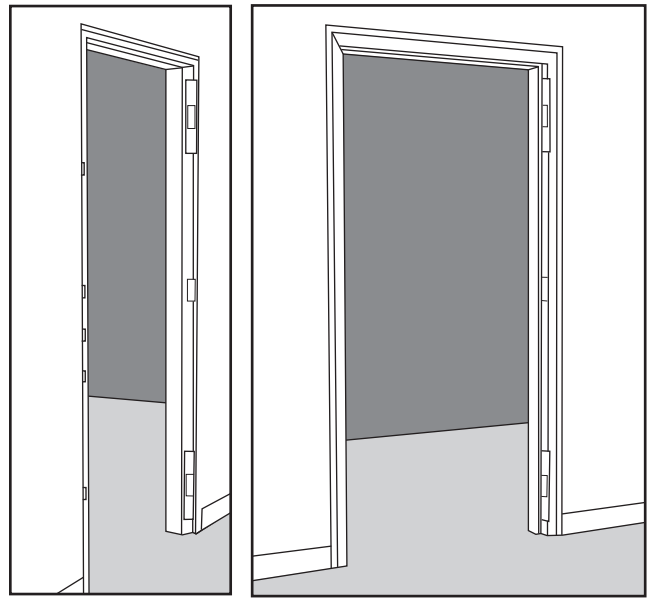

FIG. HS-06

### Jamb Shield Installation

**Note:** The door in the illustrations is removed for visual clarity only. It is not necessary to remove the door to install Door Jamb Armor.

1. Carefully remove the interior door trim moulding as this material can and should be re-installed upon installation completion (FIG. JS-01).
2. Starting on the side of the door opposite the hinges, inspect the space between the rough frame and door jamb. Locate all points that are attaching the door jamb to the rough frame as well as all shim locations. **It is particularly important that these shims stay in their locations or are at least replace similarly.**

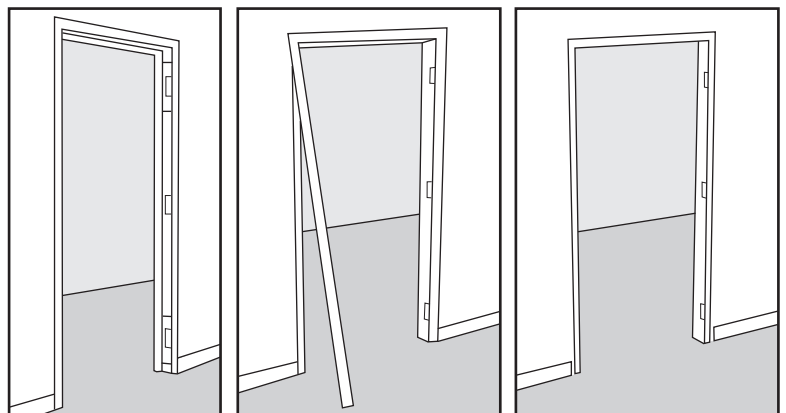

FIG. JS-01



## ASSEMBLY INSTRUCTIONS

- Using a saw with a metal cutting blade, preferably a handheld reciprocating saw, cut whatever attaching devices are currently attaching the door jamb to the rough frame (nails or screws). Screws can and should be unscrewed if the heads are visible. This will accommodate separation of the door jamb to the rough frame and allow the Jamb Shield to be placed around the door jamb with the long leg extending between the door jamb and rough frame. **It is extremely important that any attaching devices are cut flush with the door jamb (FIG. JS-02).** Failure to do so could hinder proper placement of the Jamb Shield. Any shims in this area will also have to be temporarily moved aside to allow the Jamb Shield to be put into position.

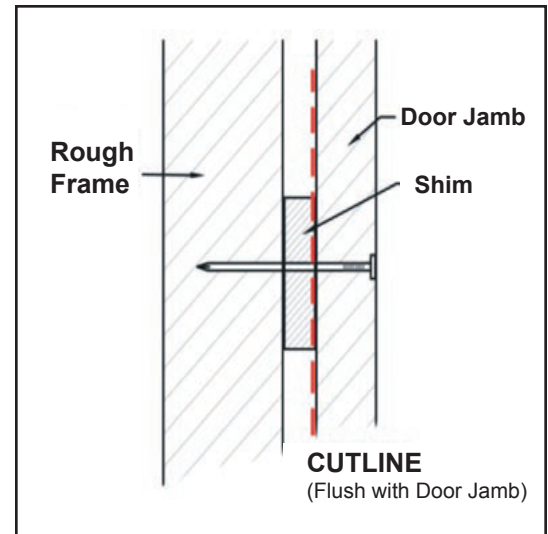

FIG. JS-02

- When positioning the Jamb Shield care should be taken to ensure that the holes line up with the lock bolt holes in the door jamb (FIG. JS-03). On the inside of the door jamb, the short leg of the Jamb Shield should fit securely against the finished frame and behind the weather stripping. When placed properly the edge of the short leg should be hidden by the weather stripping.

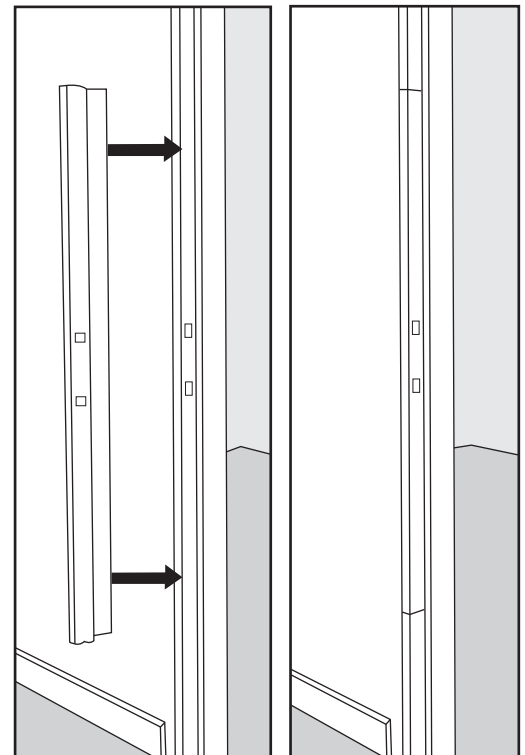

FIG. JS-03

## ASSEMBLY INSTRUCTIONS

5. While ensuring that the Jamb Shield remains properly positioned, shim it in place. Insert the shims far enough to ensure that the securing screws will pass through them. Leave the shims hanging out for now as this will allow you to hold them in place while pre-drilling and inserting the securing screws (see Note).

With an  $11/64$  in. drill bit, pre-drill the holes for the Jamb Shield as laid out on the diagram in (FIG. JS-05). Be sure to drill through the finished frame, the Jamb Shield, the door shims and at least 1 in. into the rough frame. The supplied securing screws are more than 3 inches long so pre-drilling should be deep enough to accommodate this length.

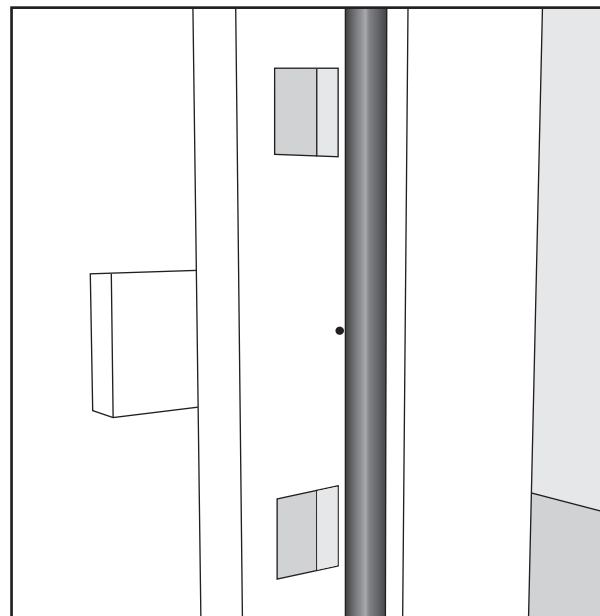

FIG. JS-04

6. Check to verify that the door and door jamb are still true. Secure the door jamb with the Jamb Shield attached to the rough frame with the supplied screws. Drive screws until the heads sit flush against the frame.
7. If the door is not true, take all necessary steps to correct this before proceeding. Once the door is true, secure the door jamb as detailed starting at step 5.

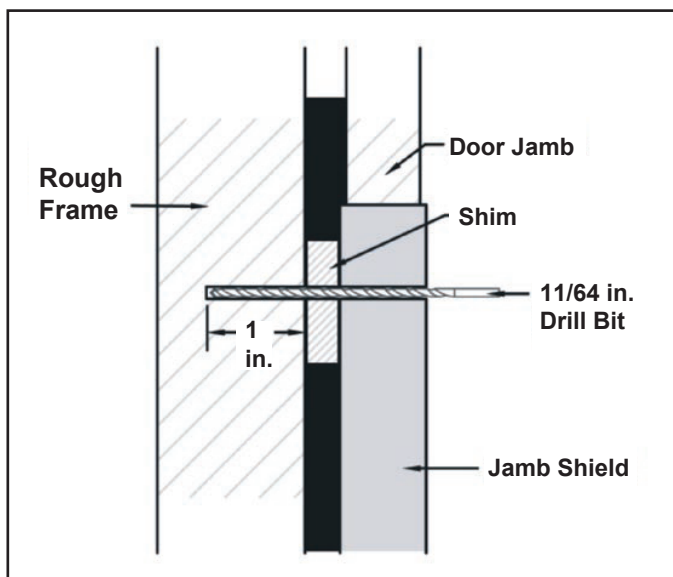

FIG. JS-06

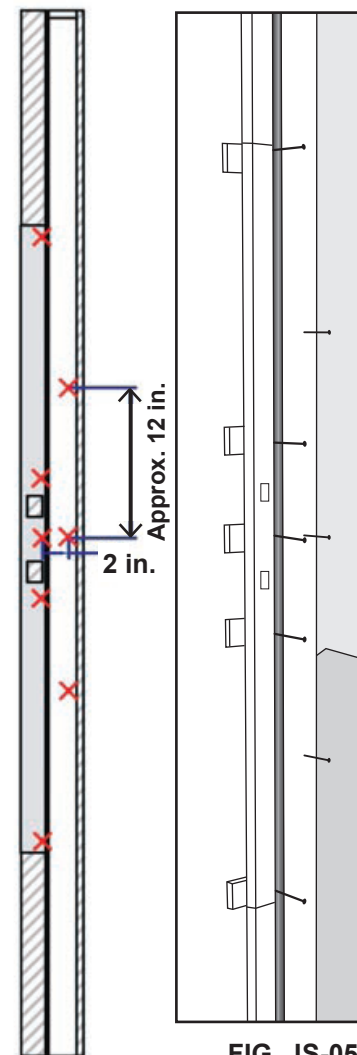

FIG. JS-05

## ASSEMBLY INSTRUCTIONS

8. Trim all shims flush with the edge of the door jamb and re-install the interior door trim moulding (FIG. JS-07).

**Note:** If Door Shield is being used with the Jamb Shield, the shim thickness behind the jamb holding the Jamb Shield may need to be decreased. This will allow the screws to pull the jamb farther towards the rough frame, increasing clearance between the Door Shield and the Jamb Shield.

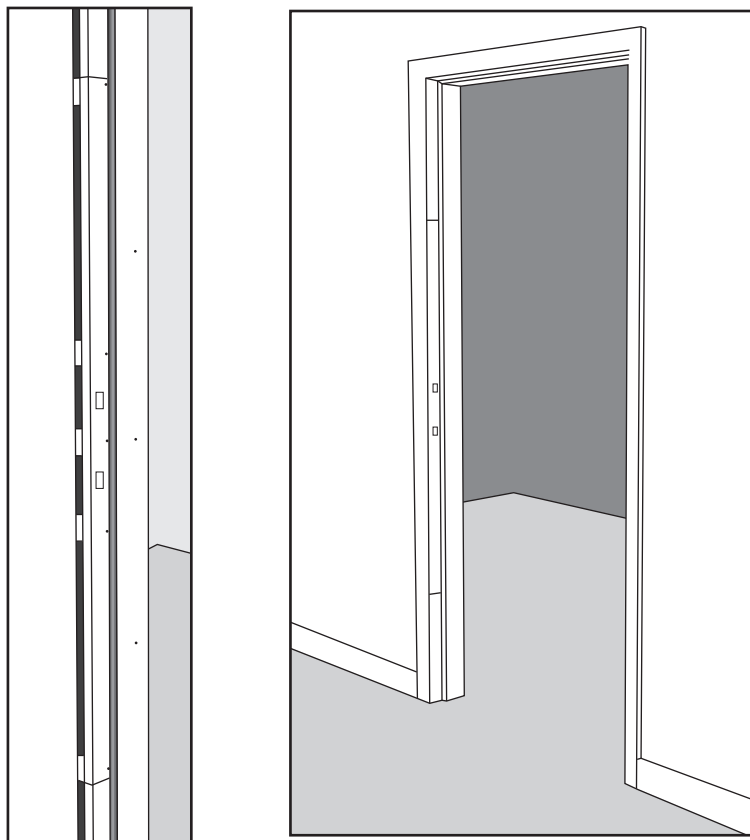

FIG. JS-07

## WARRANTY

**WARNING:** As with all products requiring installation, to reduce the possibility of accidental injury to you or others, FOLLOW ALL INSTALLATION INSTRUCTIONS contained herein accurately and carefully. Please note: Door Jamb Armor is designed to be used as a complete system, consisting of one Jamb Shield, two Hinge Shields and one, or two, Door Shields. The Seller is not liable for failure that may result from the Buyer not using all parts of the system.

The goods sold hereunder are fit and merchantable for the ordinary purposes for which such goods are used and Seller warrants the goods sold hereunder against defects in material and workmanship only for a period of one (1) year from the date of original purchase. This warranty is offered to the original Buyer of these goods and valid proof of purchase shall be required. No extended warranty is offered or implied.

Seller guarantees product for a period of three (3) years. If the purchaser's home is burglarized during that period, due to a direct failure of Door Jamb Armor, Seller will pay the purchaser's homeowner's insurance policy deductible (up to \$200). Direct failure of this product under this warranty shall be limited to the following; i). Entry into the home as a direct result of a door, equipped with an installed product, being kicked in or forced open with direct blow to the face of the door ii). Entry into home as a direct result of the Product breaking or doorjamb splitting. Entry into home through methods such as prying, cutting or due to the lock or deadbolt breaking will not be deemed as a failure of this product for the purposes of this warranty. This warranty shall be void if the Fire, Police, EMS departments or any other government agency forces entry. Any use of this product in any manner other than intended or in conjunction with illegal activity by the user will also void this warranty. Seller shall not be liable for damage or entry that is the result of the Buyer's failure to use all suggested components of the system.

Seller's liability hereunder shall be conditioned upon the Buyer's installation, maintenance, and service of the goods in strict compliance with the written instructions and specifications provided by Seller. Any deviation from Seller's instructions and specifications or any abuse, neglect, or rental use of the goods shall void Seller's warranties. In the event of any claim upon Seller's warranty, the burden shall be upon Buyer to prove strict compliance with all instructions and specifications provided by Seller. The Seller reserves the right to request an on site inspection of all goods for which a warranty claim has been filed. Upon request by the Seller the Buyer must provide the opportunity for the Seller to inspect all goods in place as they had been installed originally. In the event the Seller declines the on site inspection option, the Buyer will be responsible for ensuring all goods for which the claim is being filed are returned to the Seller. The Seller also reserves the right to request a copy of any police and/or other reports that may be filed in conjunction with the direct failure of the product and are relevant to any warranty claim. Seller's liability hereunder shall be limited to the lesser of the above-stated warranty (\$200) or the cost of replacement of the goods. Buyer agrees that Seller shall not be liable for any consequential losses arising from the purchase, installation, and/or use of the goods.