

TUMBLER AND BRUSH WASHER



USER GUIDE



CONTENTS

SAFETY 4

SAFETY INSTRUCTIONS 5
SERVICE & REPAIRS 5
SPECIFICATIONS 6

INITIAL SETUP 7

WHAT'S IN THE BOX 8

OPERATION 9

OPERATION PREP 10
CONTROL PANEL OVERVIEW 10
COMPONENT INSTALLATION AND REMOVAL 10
GENERAL OPERATION 12

CLEANING & MAINTENANCE 14

CLEANING 15
MAINTENANCE 15
LIFTING AND MOVING 15
WARRANTY 16
TROUBLESHOOTING 16

SAFETY

SAFETY INSTRUCTIONS

This document refers to Eteros Technologies' specialized component washing machine as the Mobius Automatic Tumbler & Brush Washer or the MTB Washer. This machine is not to be used for any purpose other than those expressly stated in the User Guide, advertising literature or other Eteros Technologies written material pertaining to the Mobius Automatic Tumbler & Brush Washer.

To avoid possible damage to the machine and risk of injury to the operator, consult with an Eteros Technologies representative to answer any questions. Operators are encouraged to use caution and best judgment when using equipment. Equipment should be serviced when required.

All operators must read and understand this User Guide and be trained in safe operation and use of the Mobius Automatic Tumbler & Brush Washer. We recommend the owner of this equipment develop a standard operating procedure specific to each worksite to address any local hazards or other conditions not outlined in this User Guide.

Disconnect power to the washer before servicing and when adjusting or removing the components being cleaned. The MTB Washer must be inspected regularly for damage, component failure, and wear. Results of inspection activity should be documented.

Eteros Technologies makes every effort to ensure the MTB Washer is compliant with all current safety standards. It is the responsibility of the owner to ensure all municipal, provincial, state, county, territorial, and federal codes, regulations and standards have been met in each working location, including disposal of wastewater from the machine.

Do not lend or rent your machine without providing the User Guide. A first-time operator should receive practical instruction before using the machine.

SERVICE & REPAIRS

Repairs may only be carried out by Eteros Technologies or a designated authorized agent (service technician).

Should the need arise, please notify:

ETEROS TECHNOLOGIES
502-130 INDUSTRIAL AVE.
CARLETON PLACE, ONTARIO, CANADA
K7C 3T2
www.ETEROS.com

Improper interfacing, improper repair, or unauthorized modification could result in void warranty claims.

SPECIFICATIONS

Construction	304 / 316 SS, HDPE, Delrin (Black Acetyl)
Speed Adjustments	N/A
Drive Motor	1/8 HP (90W)
Power Requirements	110/115VAC, 60Hz, 1.51/1.54A
Tool-less Use	Yes
Tool-less Disassembly	No
Fits Through Door	Yes
Width	32.25"
Length	62.5"
Height	43.5"
Weight	270lbs
Warranty	1 year
Machine Certifications	None
Motor Certifications	UL / CSA / CCC / EN / CE
Accessories	None

INITIAL SETUP

WHAT'S IN THE BOX

Your MOBIUS AUTOMATIC TUMBLER AND BRUSH WASHER comes fully assembled, tested, and ready for operation. It includes the following removable parts:

- INTERNAL ROTATIONAL SPREADER
- DRAINAGE HOSE

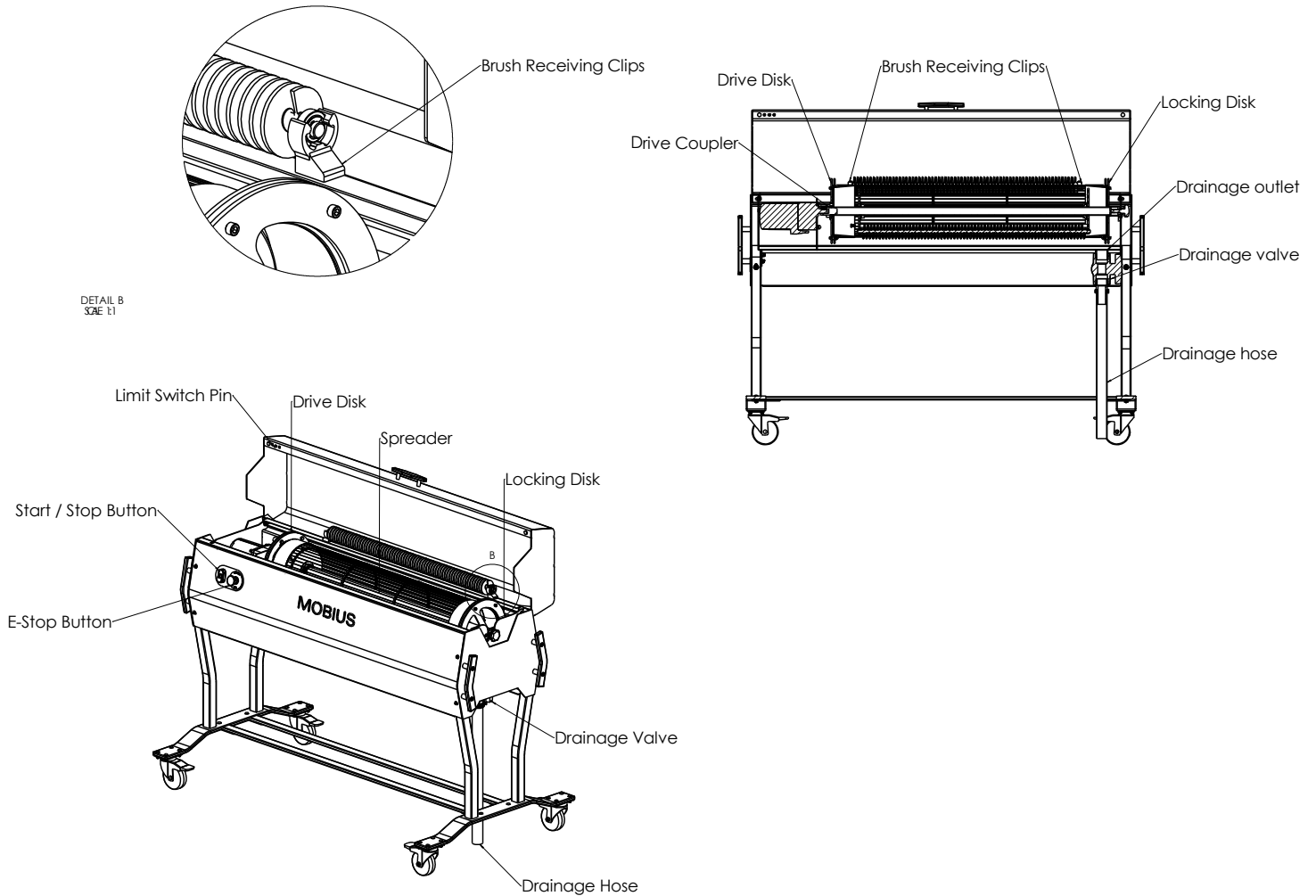

OPERATION

OPERATIONAL PREP

Please take the following steps to confirm the MTB Washer is ready to operate:

- Complete a thorough inspection of the equipment to ensure there is no damage and that all components are in place. Ensure all screws on spreader assembly are tight.
- Confirm the power cord is in good condition.
- Ensure the lid is properly installed with the limit switch pin in place
- Ensure that the equipment is in a clear and tidy workspace and that all controls are accessible
- Connect the drainage hose to the drainage outlet on the MTB Washer basin and ensure that the valve on the outlet is closed.

CONTROL PANEL OVERVIEW

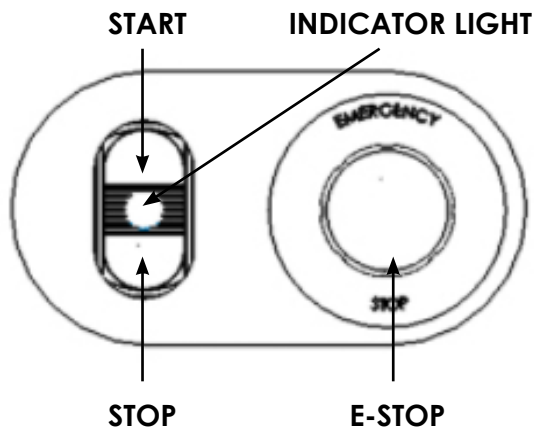

E-STOP - Prevents accidental start-up, used for servicing and removing components.

START - Starts motor rotation

STOP - Stops motor rotation

LIGHT - Green when powered on (running)

COMPONENT INSTALLATION AND REMOVAL



Remove the spreader assembly from the washer and place the drive (left) end on the ground



Remove the locking disk from the main shaft of the spreader.



Slide the tumbler over the main shaft of the spreader and replace the locking disk on the shaft. Don't tighten yet!

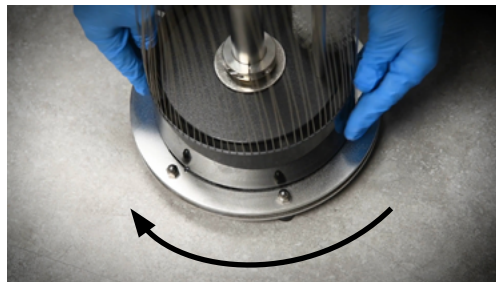
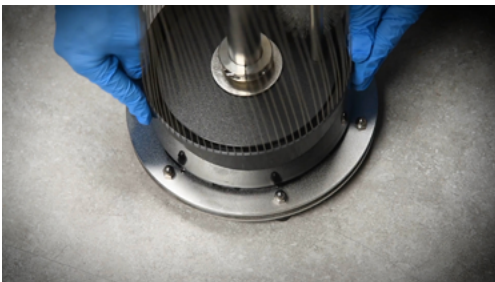

Slide the tumbler end cap at the bottom into the matching profile at the base of the spreader. Rotate clockwise to lock in place.

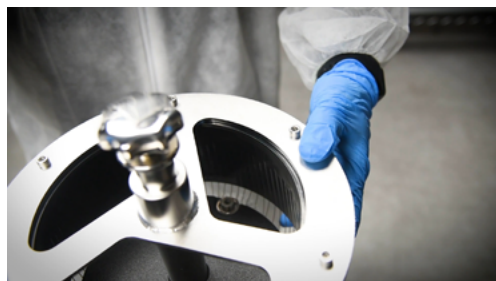

Lift opposite tumbler end cap up and interlock with matching features on the locking disk.

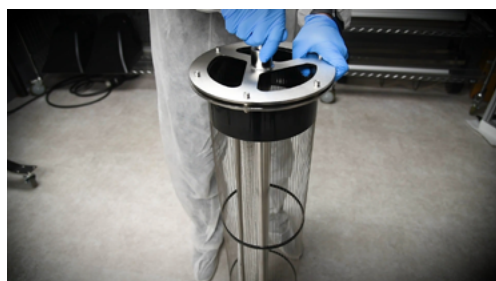

Holding the tumbler end cap on the bottom end to keep locked into place, rotate the knob on the locking disk clockwise to tension the tumbler. The wires must be taut for cleaning.

Before operating, ensure tumbler wires are taut on spreader - this generates better cleaning results and prevents the tumbler from getting caught up during the wash cycle.

To remove, rotate the knob counter-clockwise to de-tension the tumbler, then rotate the tumbler end caps to disengage the tabs at both ends, remove the locking disk and remove the tumbler from the spreader.

GENERAL OPERATION

MACHINE START UP SEQUENCE

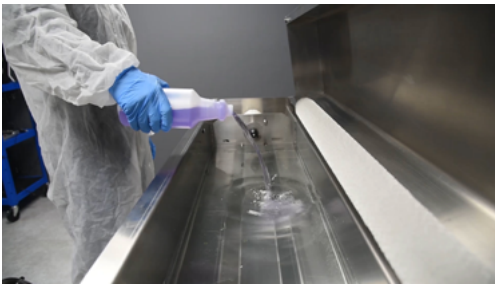

Begin by filling washer basin approximately half full with warm or hot water. The fill slots on the motor mount plate will prevent you from over-filling the basin. It is recommended that water temperature not exceed 65°C (150°F).

Add a degreasing solution of your choice to the basin. The amount to be added should be based on the manufacturer's recommended dilution ratio. Note, cleaning agents should be added after filling the basin with water to avoid excessive foaming.



Install the soiled M108S brush into washer by clicking each end of the brush into the receiving clips on the lid. These work the same way that they do in the M108S lid.



Lift the spreader at each end and lower it into the basin, resting the knob-end on the plastic support on the right-hand side.



Lift the left end cap and slide it towards the motor to align the drive cone. Rotate the assembly to align the drive pin with one of the holes in the spreader plate. As you do so, the shaft at the knob side should fall down into place on the plastic support.

Rotate the spreader once by hand to ensure the system will rotate freely.

Close the lid. This will bring the limit switch pin into position and allow the machine to start. It will not operate with the lid open.

OPERATING

Release the e-stop by rotating it clockwise.

Press the start button to begin rotation and cleaning.

Set a timer (not included) for 5 minutes to start. The length of time can be adjusted to suit the soil level of your tumbler and brush, but this is a good place to start.

Press the stop button to stop rotation.

Open the lid and visually inspect the tumbler and brush.



If not sufficient, restart the wash cycle until desired cleanliness is achieved.

If sufficiently washed, press the e-stop to lockout the machine before proceeding.

MACHINE STOP & SHUTDOWN SEQUENCE

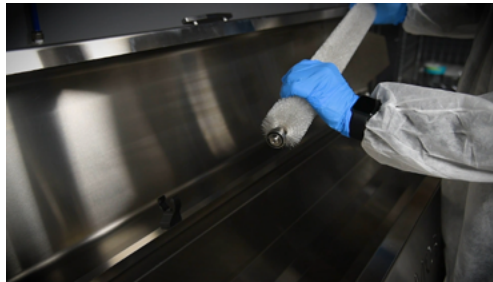
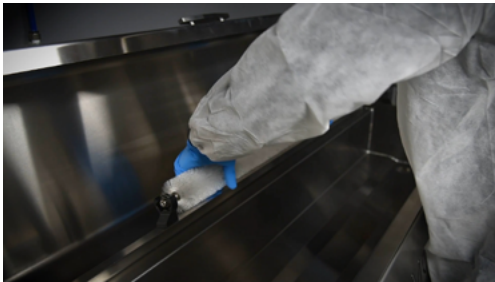

Remove the brush by grasping it at both ends and pulling gently to release it from the clips. Rinse off and set aside to dry. We recommend using the end bearings as support during drying so that the bristles do not dry flat.

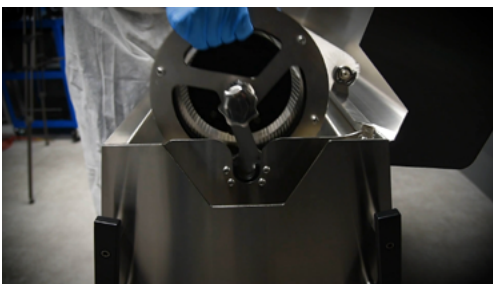

Remove the spreader from the basin by lifting the right hand side and sliding to the right to disengage drive pin before lifting the assembly fully out of the basin. Set the assembly down and rinse off. Remove tumbler from spreader.



Repeat as many cycles as required. At the end of the cleaning session, push the e-stop and unplug the machine.

Drain cleaning solution from the washer basin and dispose of as required by site or municipal regulations.

Rinse tub and spreader to remove any debris and clean as required. Avoid spraying water directly onto electrical panel or surrounding area.

Reassemble spreader and re-install in tub for storage until next use.

CLEANING & MAINTENANCE

ENSURE THAT THE MOBIUS AUTOMATIC TUMBLER AND BRUSH WASHER IS LOCKED OUT BEFORE PERFORMING ANY SETUP OR MAINTENANCE.

CLEANING

With the exception of the electrical enclosure, the MOBIUS AUTOMATIC TUMBLER AND BRUSH WASHER can be washed, cleaned, and wiped down with normal detergents, degreasers, and disinfectants.

The lid and facias can be removed to facilitate cleaning. The inside of the MTB WASHER can be washed and wiped as needed.

The exterior of the MTB WASHER can be hosed or sprayed, except in the control panel area. Evidence of water near the electrical panel could void the machine warranty.

MAINTENANCE

The MOBIUS AUTOMATIC TUMBLER AND BRUSH WASHER is largely maintenance-free.

The components that support the spreader shaft are the only parts that may experience wear. The condition of these surfaces should be inspected before each use. If you begin to notice galling on the stainless-steel surface or significant wear of the plastic surfaces, contact ETEROS TECHNOLOGIES to obtain a replacement component.

This User Guide does not include instructions for machine repair. For your safety, repairs must be completed by ETEROS TECHNOLOGIES or an authorized agent (service technician).

Should repairs be required, please contact:

ETEROS TECHNOLOGIES
502-130 INDUSTRIAL AVE.
CARLETON PLACE, ONTARIO, CANADA
K7C 3T2
www.ETEROS.com

Improper interfacing, improper repair, or unauthorized modification could result in void warranty claims.

LIFTING AND MOVING

The machine is easily moved and rolled on level surfaces. The machine includes four locking swivel casters that are installed at the factory. The machine is designed to be operated on smooth and level floors.

If lifting is required, the MOBIUS AUTOMATIC TUMBLER AND BRUSH WASHER must be lifted using a forklift on the lower surface of the body. Ensure that the forks are fully spread to avoid overturning or flipping off the forks.

DO NOT LIFT FROM THE STRUTS AT THE BOTTOM OF THE MACHINE.

WARRANTY

For a period of one (1) year after equipment shipment, ETEROS TECHNOLOGIES ("Seller") warrants the MOBIUS AUTOMATIC TUMBLER AND BRUSH WASHER shall be free from defects in material and workmanship.

In the event of an issue covered under warranty, the original owner/purchaser of the of the MOBIUS AUTOMATIC TUMBLER AND BRUSH WASHER must contact ETEROS TECHNOLOGIES to file a claim. Prolonged operation of a damaged machine may cause additional damage and/or wear not covered by warranty.

ETEROS TECHNOLOGIES

502-130 INDUSTRIAL AVE.

CARLETON PLACE, ONTARIO, CANADA

K7C 3T2

www.eteros.com

The seller understands the cost of downtime and will make every reasonable effort to process approved warranty claims and repairs as quickly as possible. In some instances, the owner/purchaser may need to ship the equipment to the Seller's manufacturing facility to complete the repairs. The repairs will come at no cost to the owner.

TROUBLESHOOTING

WILL NOT START

- Ensure the machine is plugged in
- Ensure the e-stop is disengaged (twist to release)
- Ensure the limit switch pin is present and the lid closes properly
- Ensure motor and spreader are not jammed / lodged

DEVICE IS ABNORMALLY NOISY

- Ensure that the spreader assembly is installed correctly
- Ensure that the drive pin is properly engaged
- Check for wear on components that support rotating assembly

TUMBLER / BRUSH IS NOT CLEAN ENOUGH

- Ensure correct cleaning solution, concentration and water temperature are used
- Adjust time of cleaning to ensure enough scrubbing exposure time
- Check for debris and buildup in cleaning solution. Fresh cleaning solution may be required.



Eteros Technologies West
202-17665 66A Ave.
Surrey, BC
V3S 2A7

Eteros Technologies East
502-130 Industrial Ave.
Carleton Place, ON
K7C 3T2

1-866-874-6244
INFO@MOBIUSTRIMMER.COM
MOBIUSTRIMMER.COM