

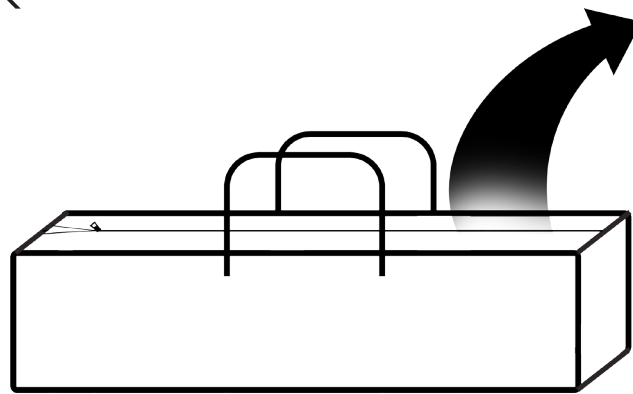

Instructions

9x9 Gorilla Grow Tent

1. Unpack



2. Check

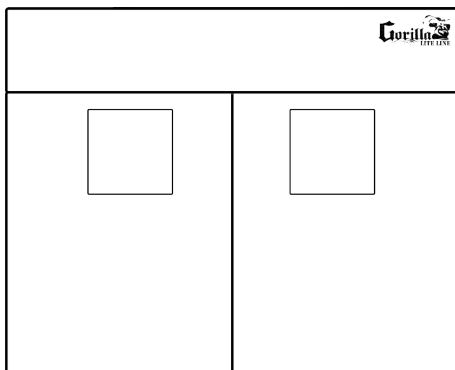

1x
Tent

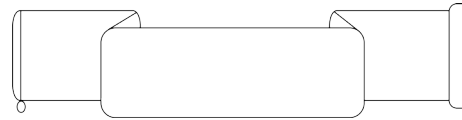

1x
Extension Skirt

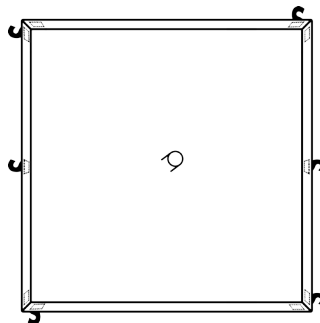

1x
Spill Pool

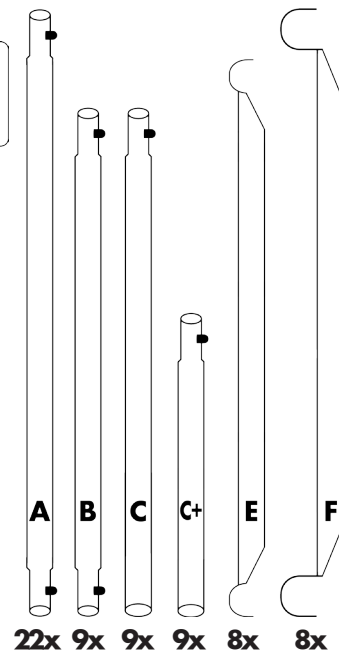

22x 9x 9x 9x 8x 8x
Poles

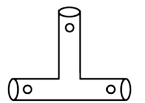

3x
3 Way
Connector

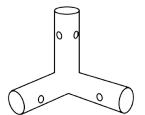

8x
Corner
Piece

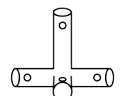

6x
4 Way
Connector

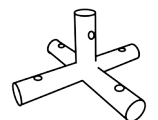

1x
5 Way
Connector

3.

Unfold, unzip, then lay flat.

NOTE: Your tent may look different than this illustration.

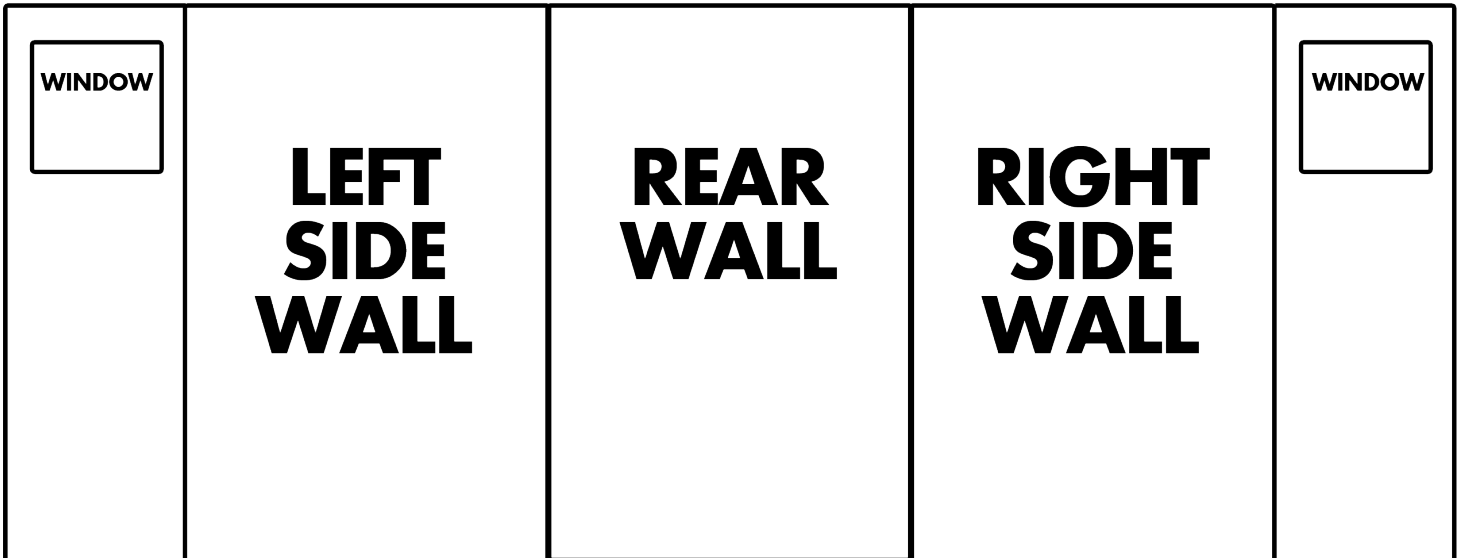
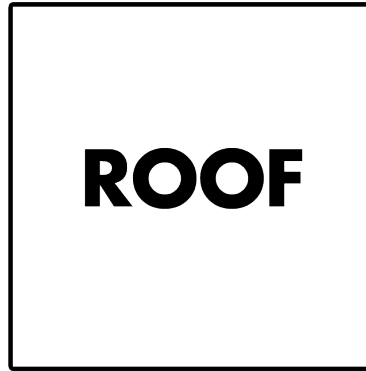

4. Assemble frame inside of tent floor beginning with frame base, and building upward

*If you do not plan on using the height extension DO NOT add the C+ poles

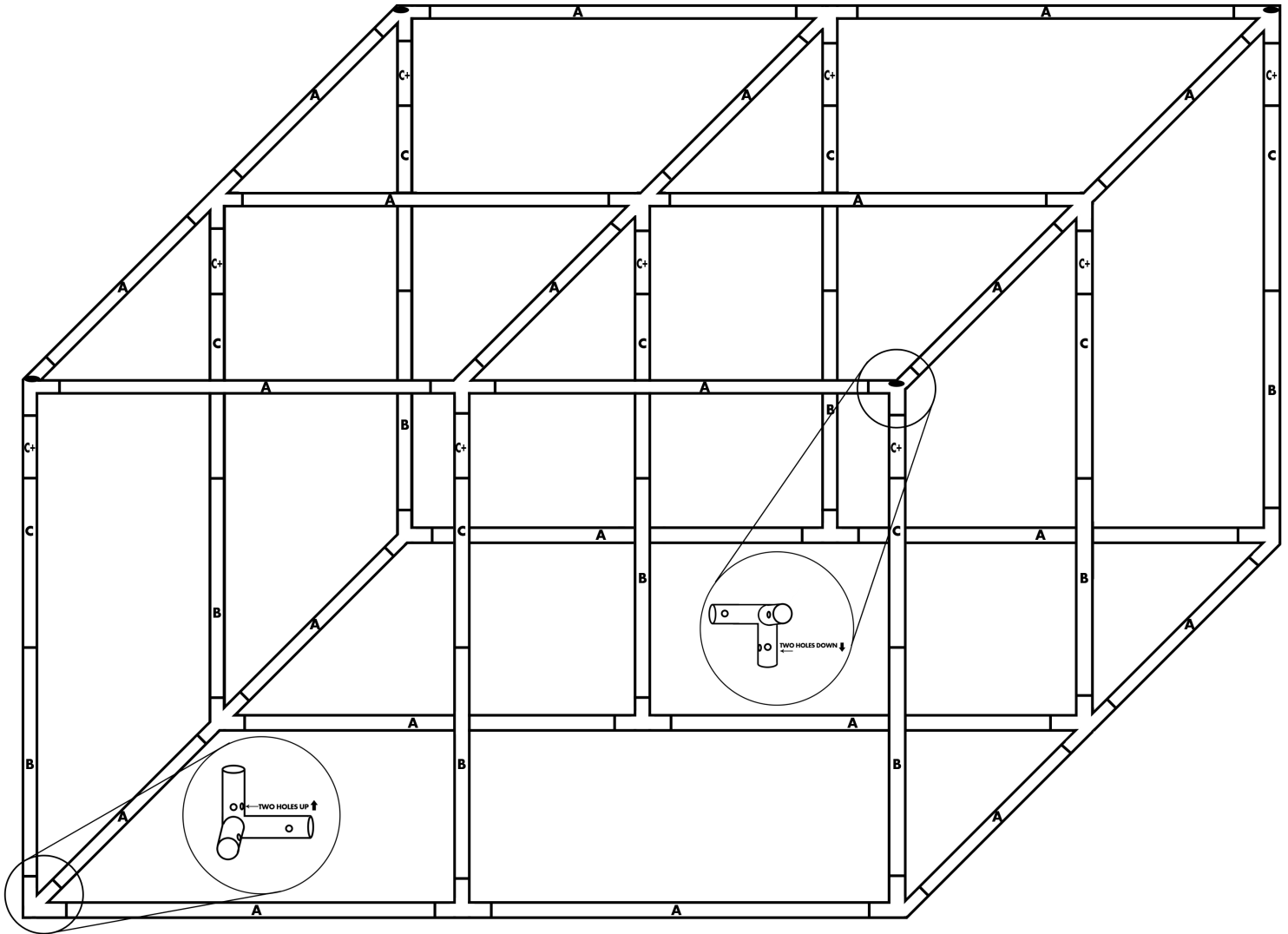

- 5.** Place roof onto tent frame.
Carefully guide each corner of the roof over each corner of the frame a little at a time. This will allow plenty of slack to properly fit the corners. Do not fully seat the roof at one corner and attempt to stretch corners over frame. Do not use excessive force. Doing so may damage your tent and void warranty.

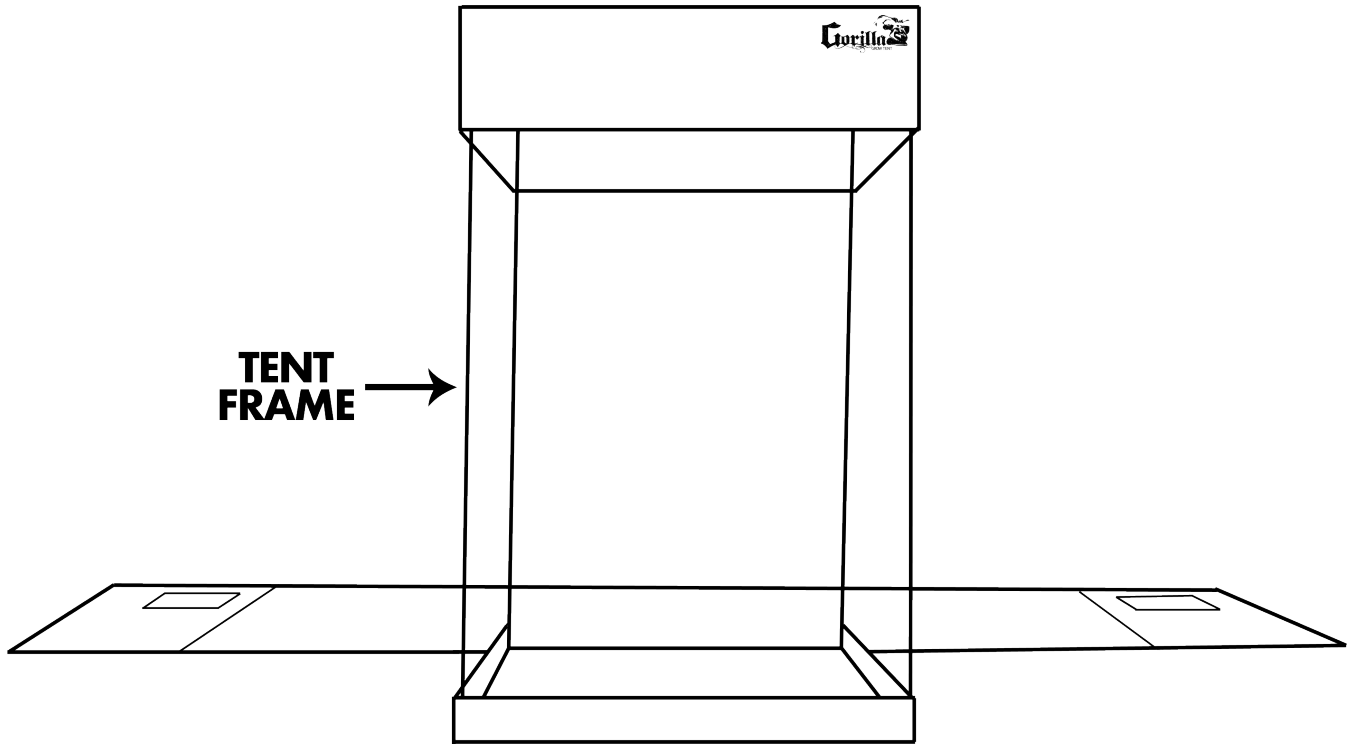

- 6.** Starting at the back of the tent add & zip extension skirt
* If you are not using the height extension, skip to step 7

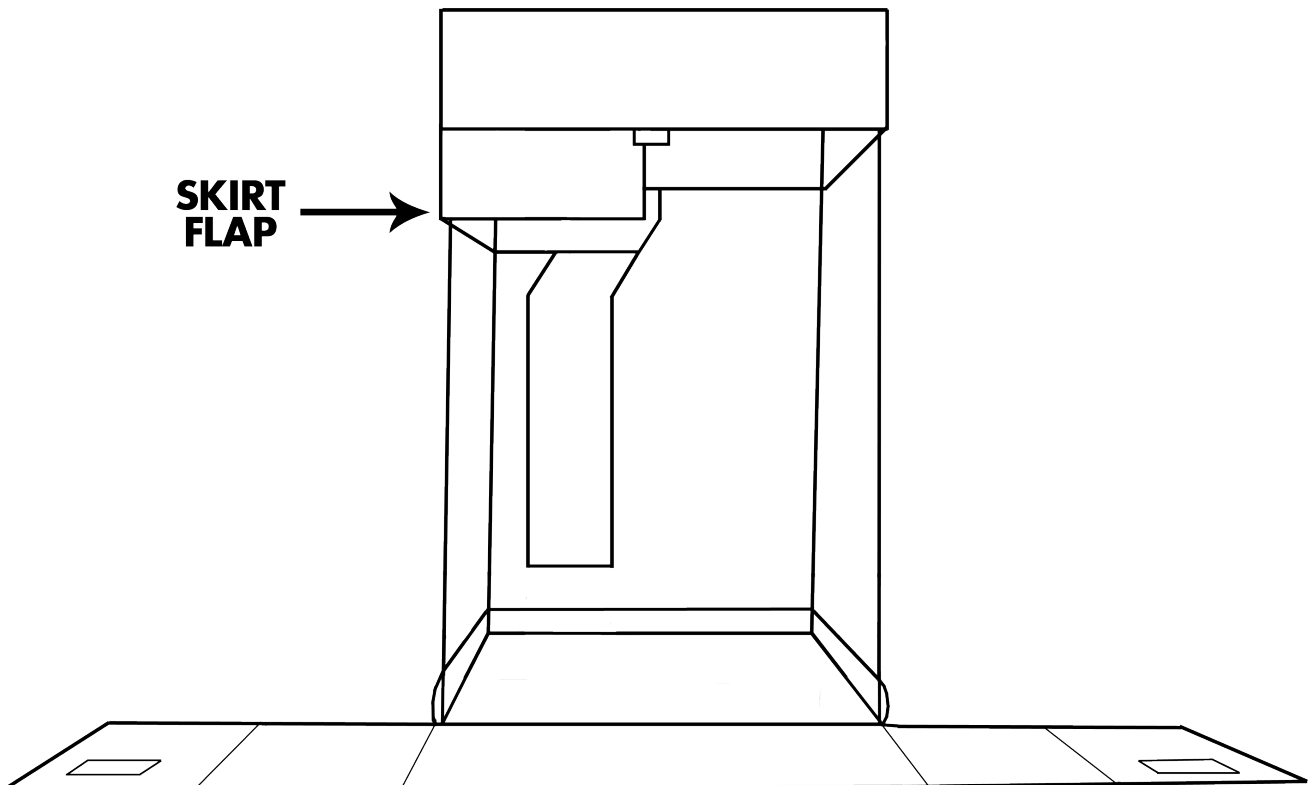

Zipper Detail

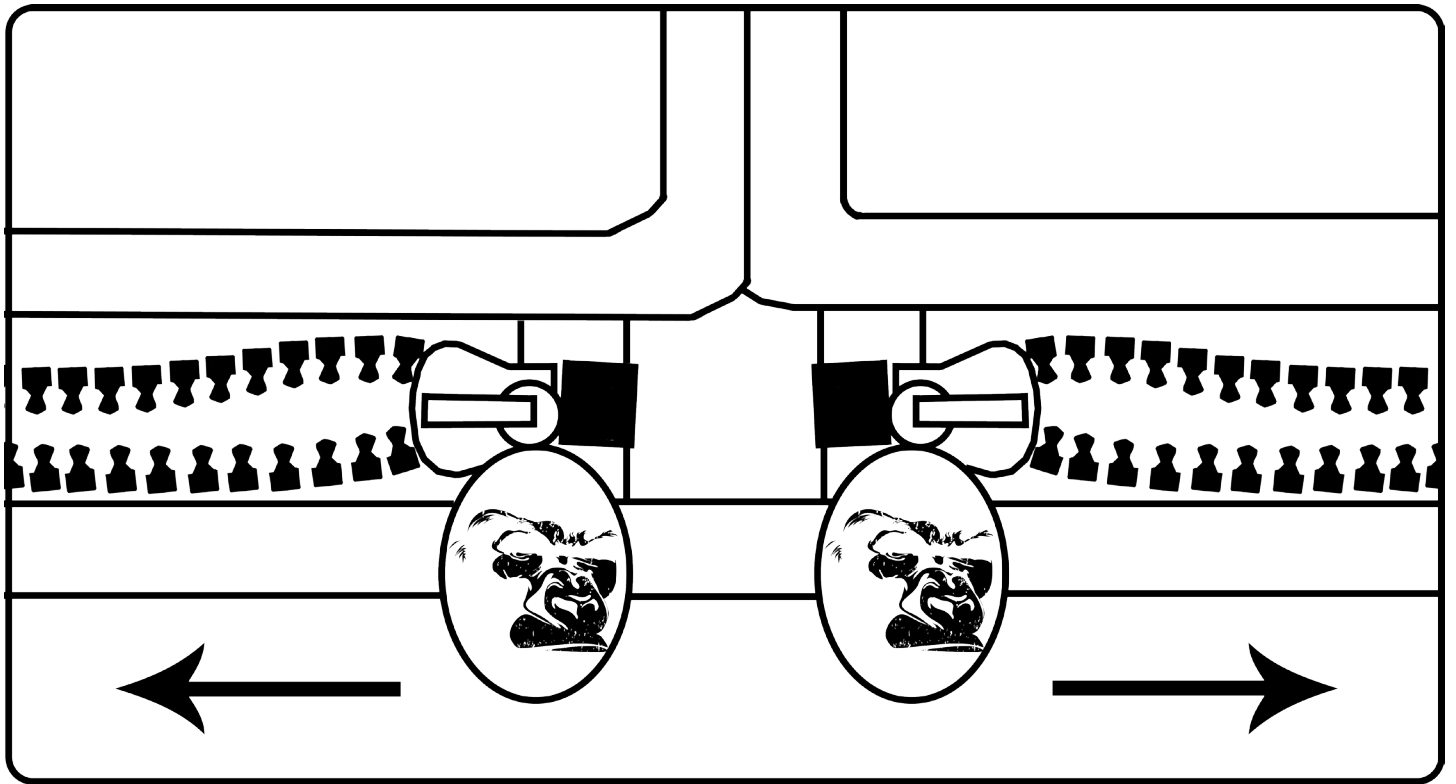

7. Bring Tent Body To Velcro Assist Strips & Zip Tent

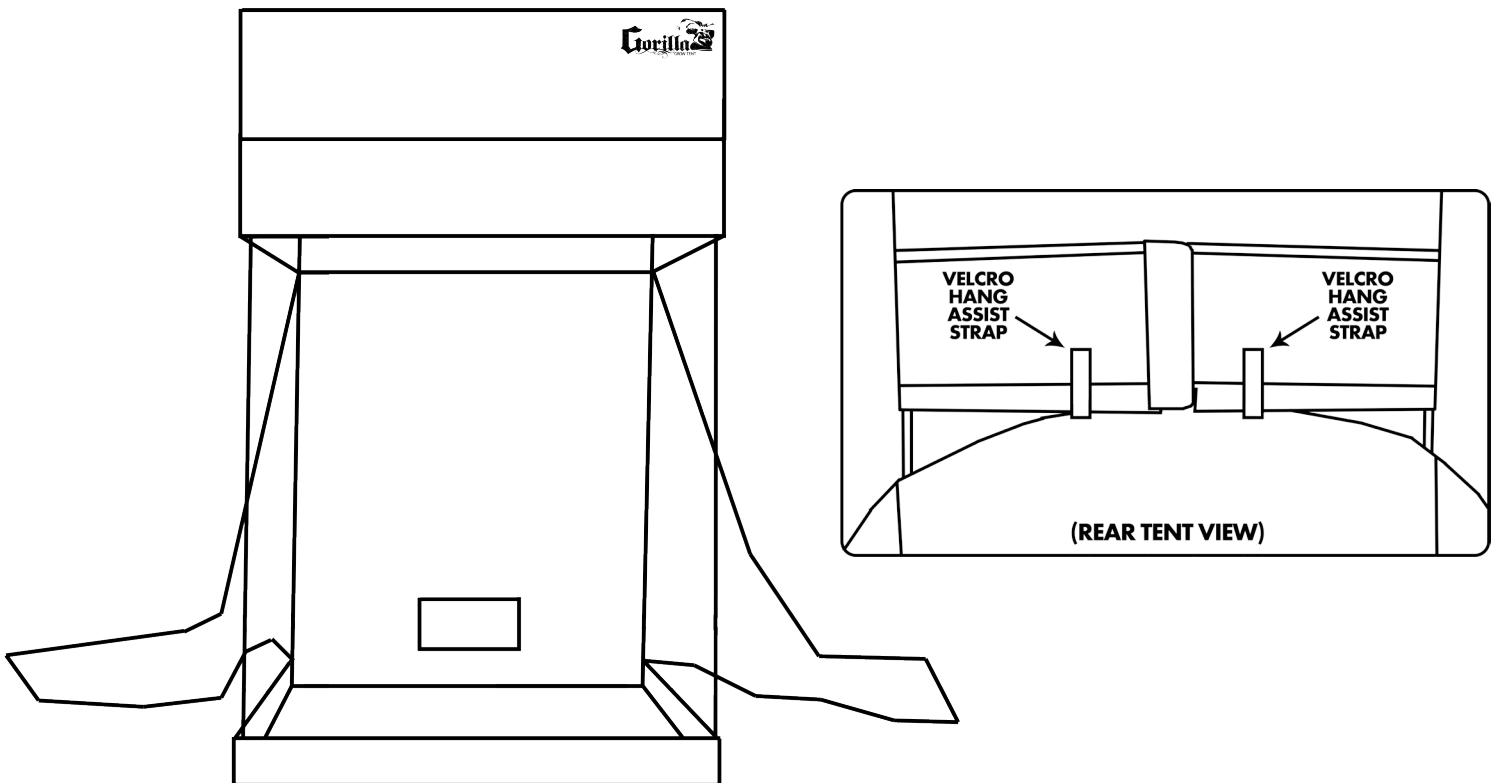

8. Add Roof Support Beams. Position E poles, then F pole. E poles are load bearing.

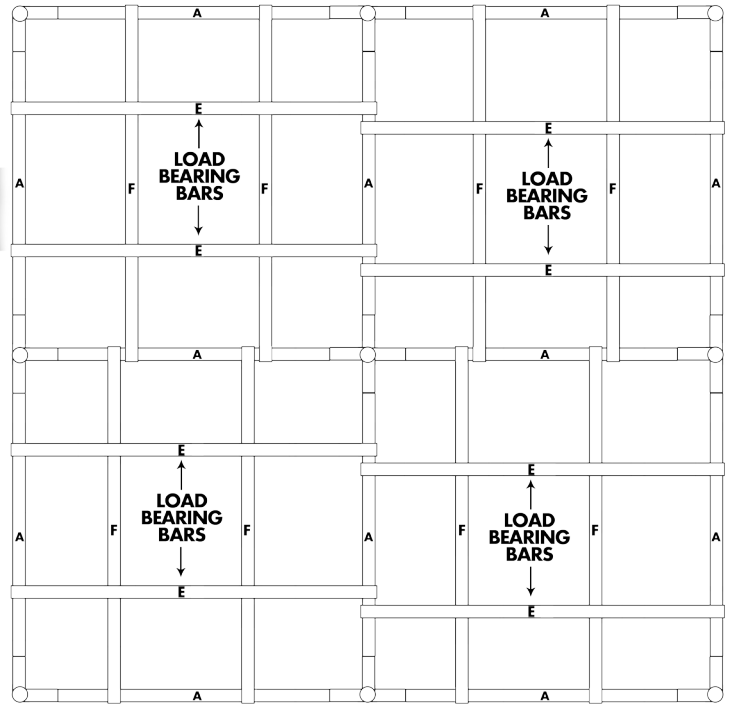
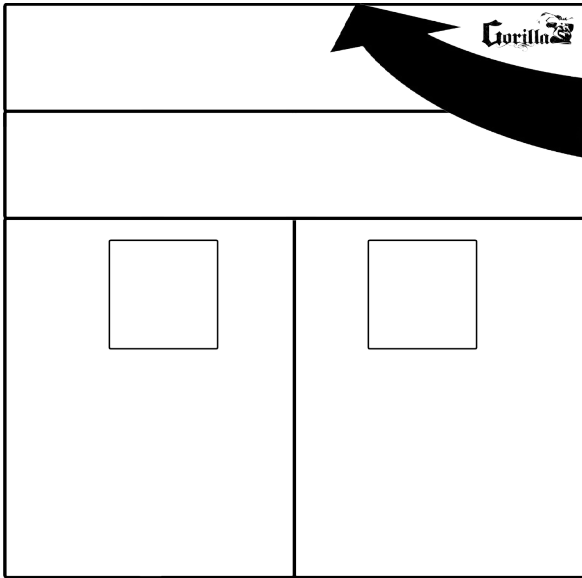

9. Place spill pool on floor of tent and secure Velcro straps around poles.

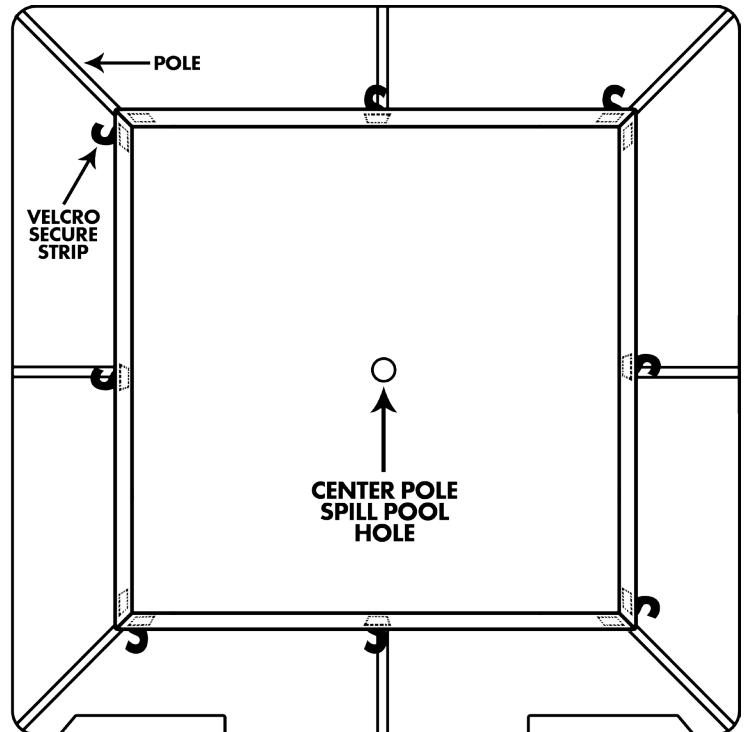
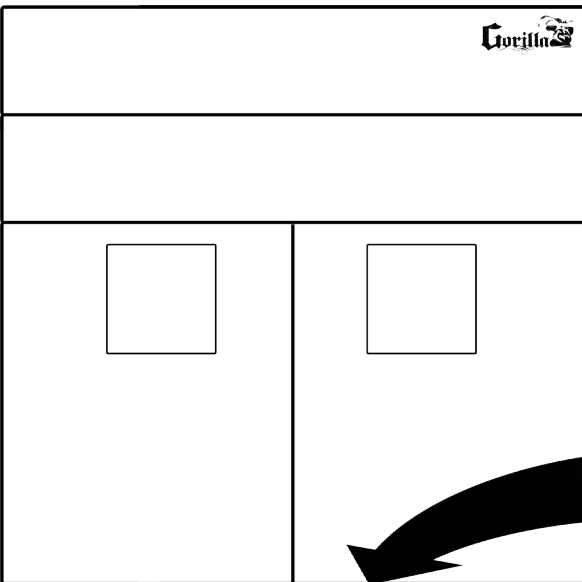

TALLEST. THICKEST. STRONGEST.

WWW.GORILLAGROWTENT.COM 1-855-G₄G₄T₈-G₄R₇O₆W₉