

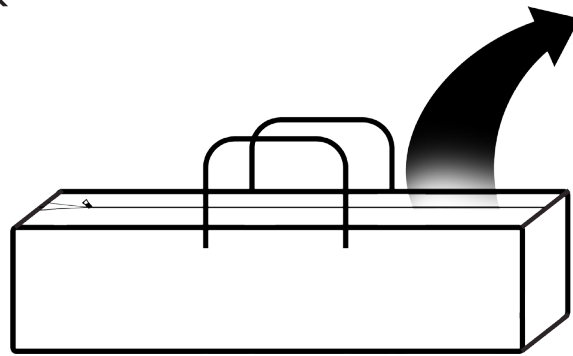

Instructions

8x16 Gorilla Grow Tent

1. Unpack



2. Check

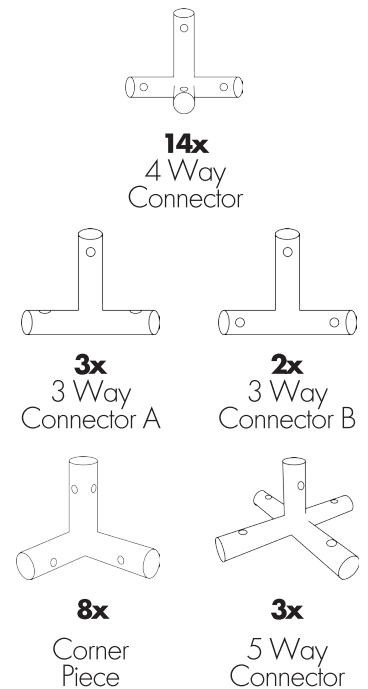
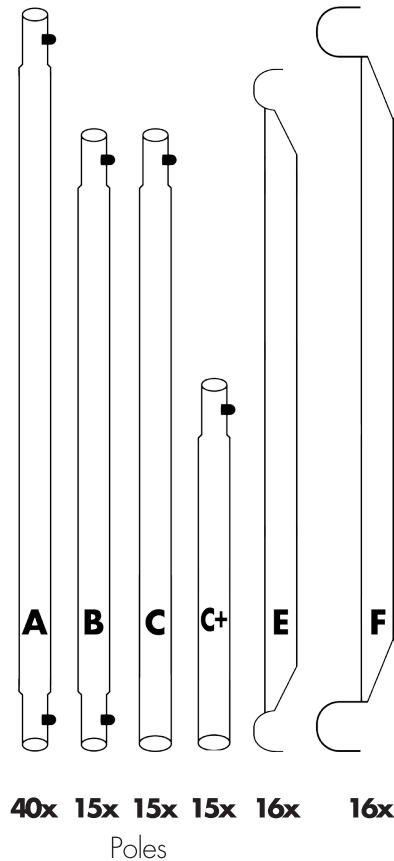
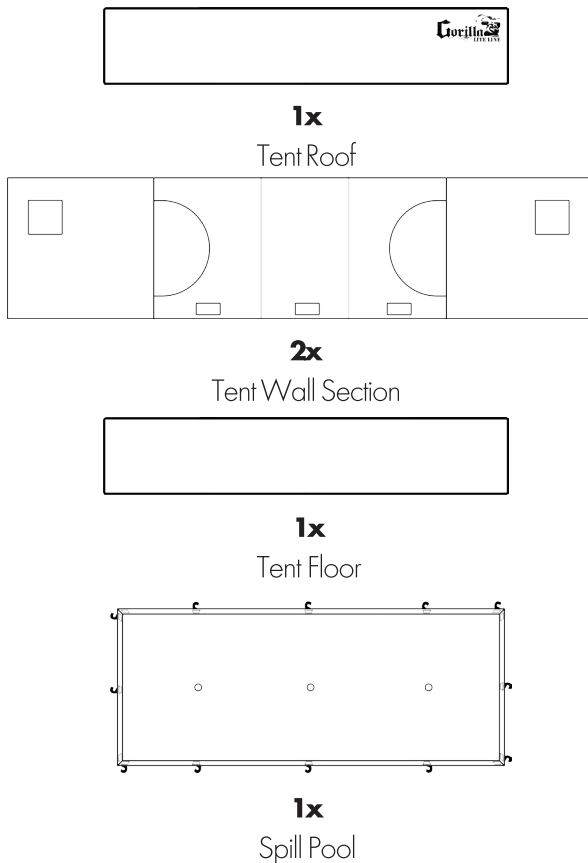

3. Lay tent floor flat. Assemble frame inside of tent floor beginning with frame base, and building upward

**If you do not plan on using the height extension DO NOT add the C+ poles*

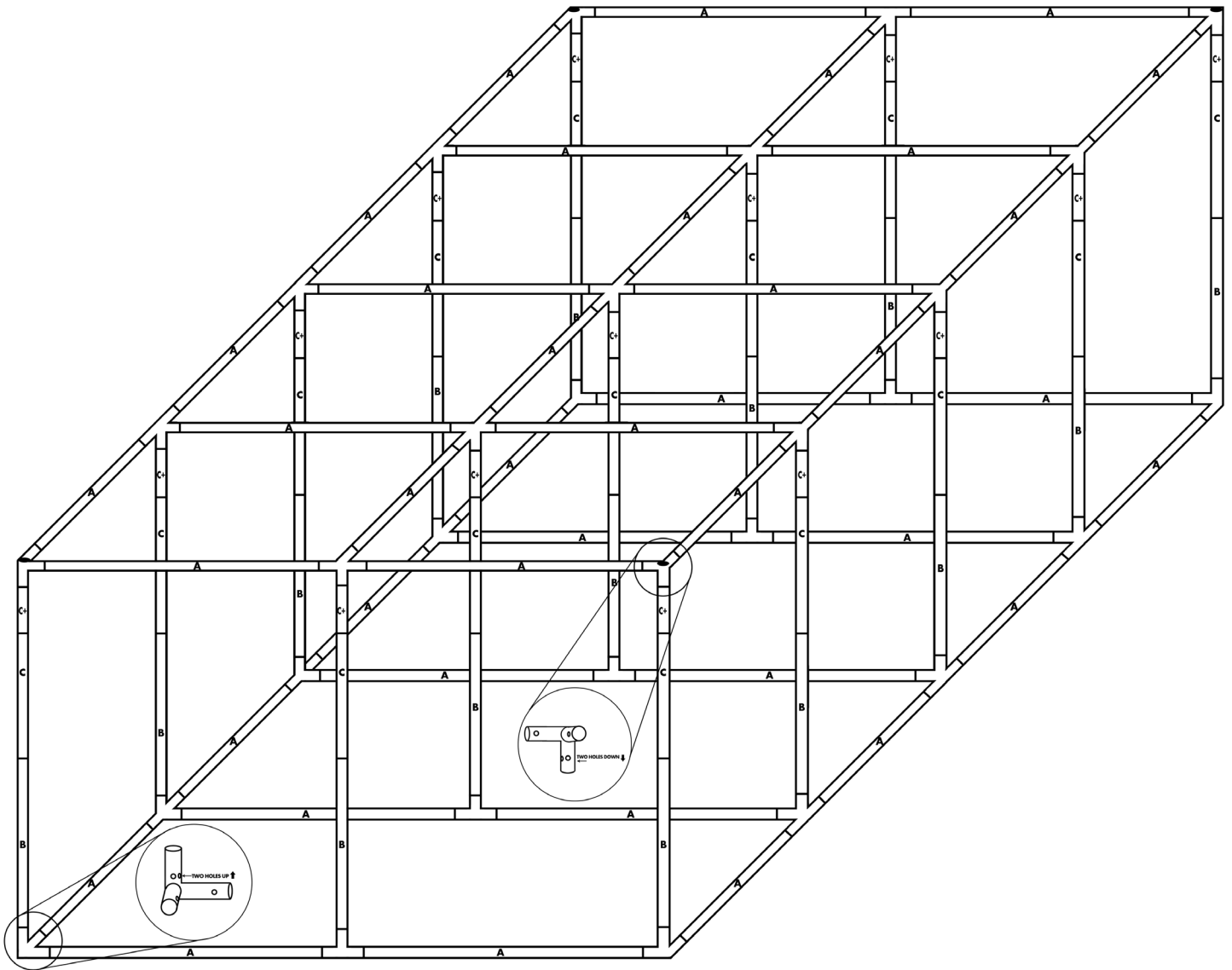

4. Place roof onto tent frame.

Align the zipper stops in the front and back of floor with the terminations on the roof. Carefully guide each corner of the roof over each corner of the frame a little at a time. This will allow plenty of slack to properly fit the corners. Do not fully seat the roof at one corner and attempt to stretch corners over frame. Do not use excessive force. Doing so may damage your tent and void warranty.

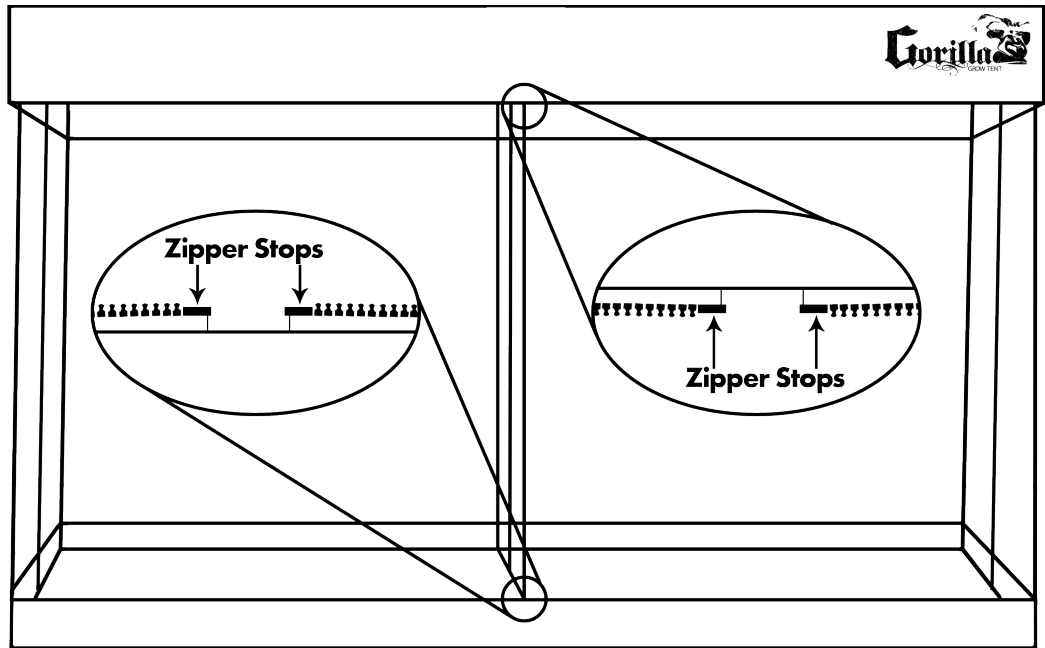

**Your tent may differ slightly from this graphic.*

5. Starting at the back of the tent add & zip extension skirt

**If you do not plan on using the height extension, skip to Step 6*

**SKIRT
FLAP** →

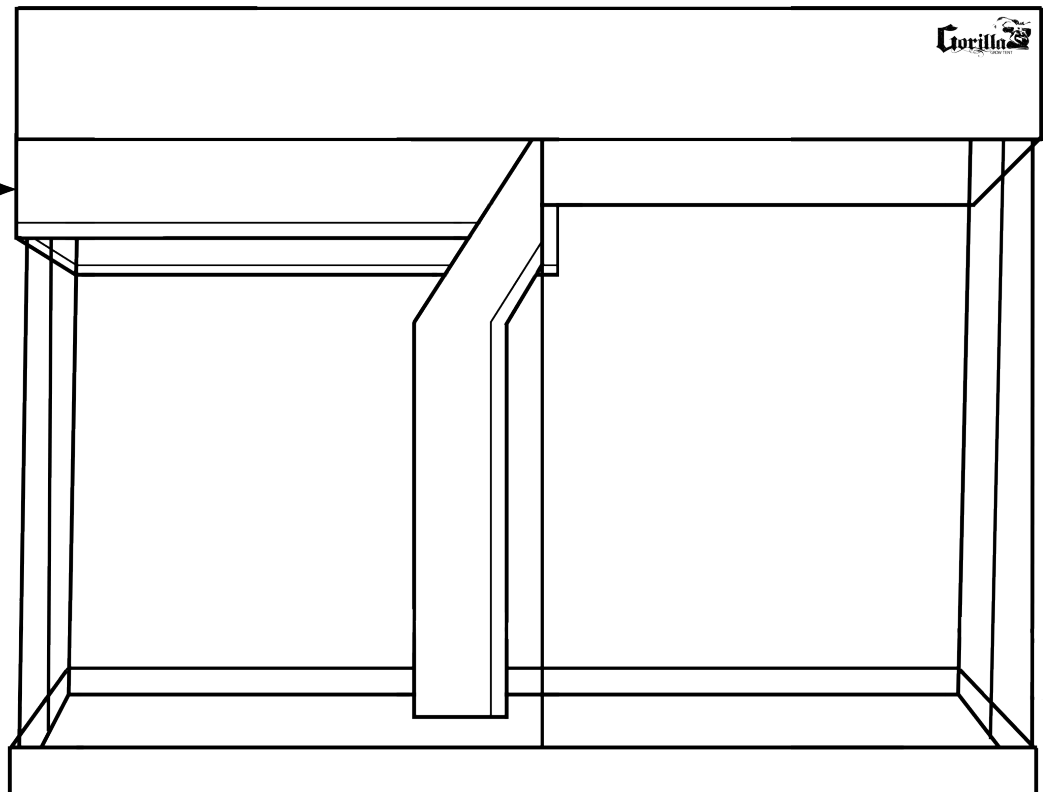

**Your tent may differ slightly from this graphic.*

Zipper Detail

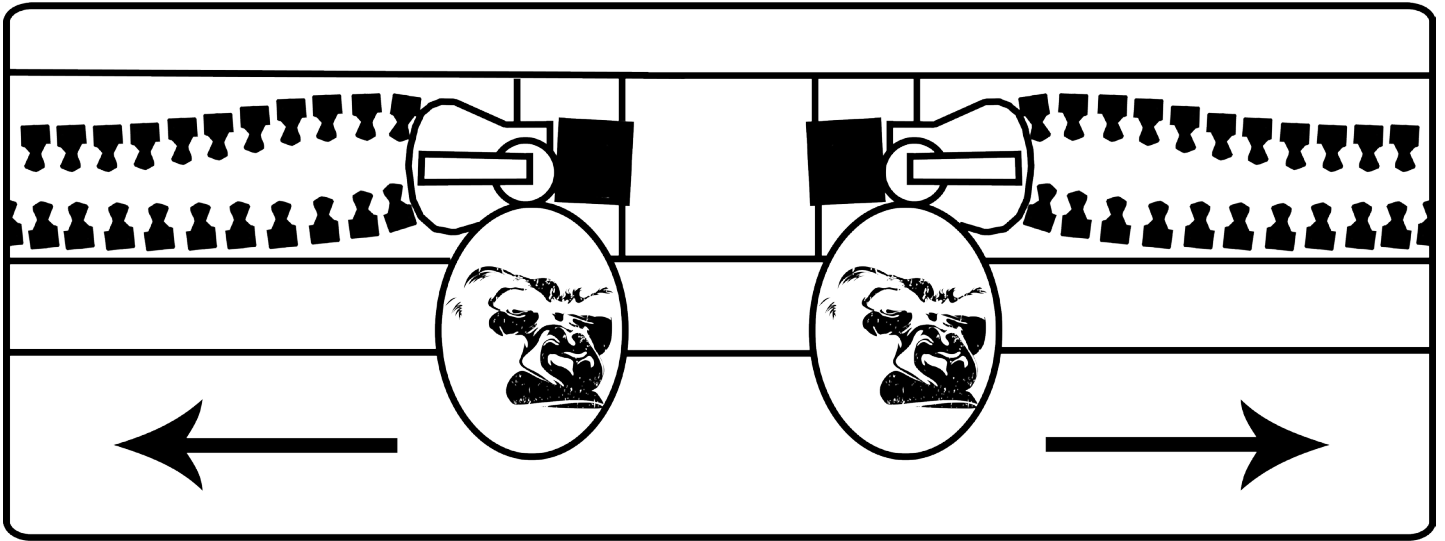

6. Bring tent wall to Velcro assist strips then zip tent.

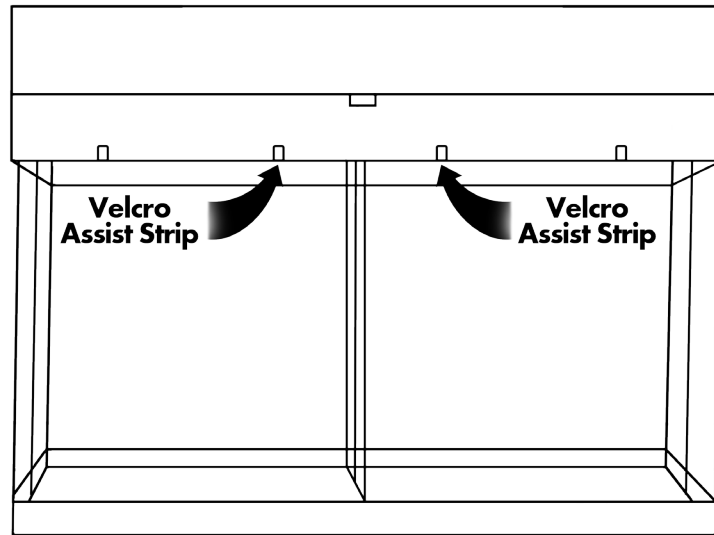

Wall Section

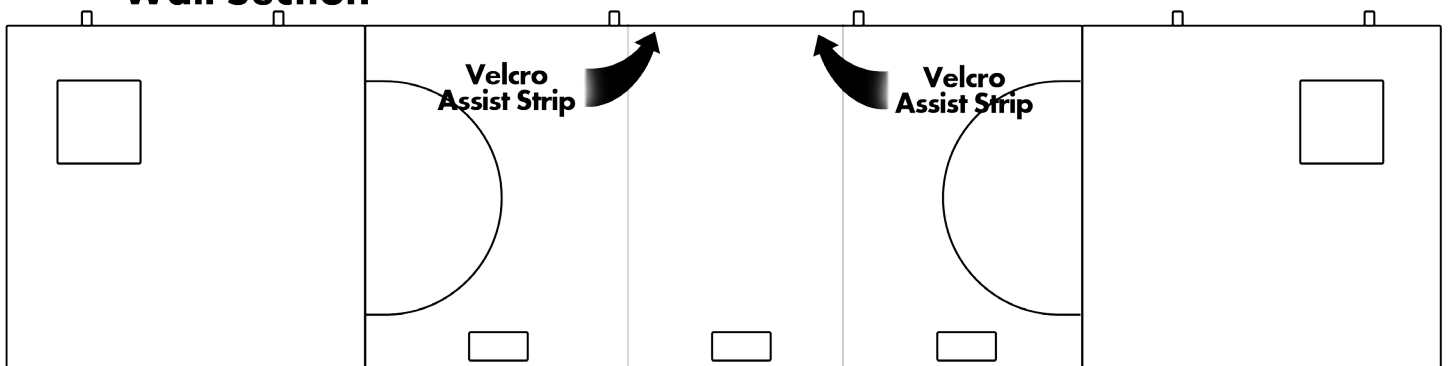

7. Add Roof Support Beams. Position E poles, then F pole.
● E poles are load bearing.

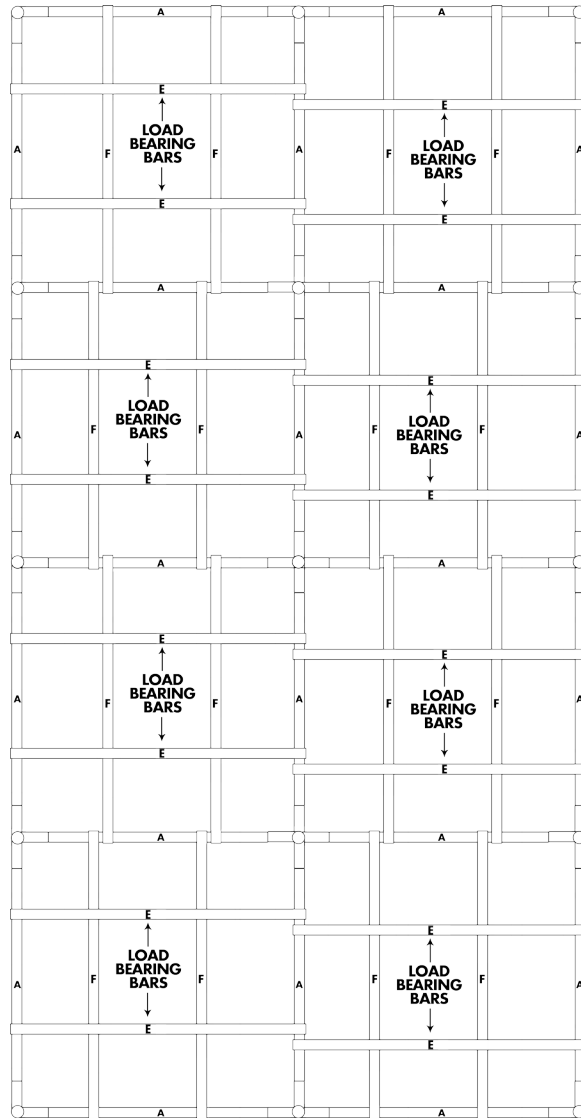
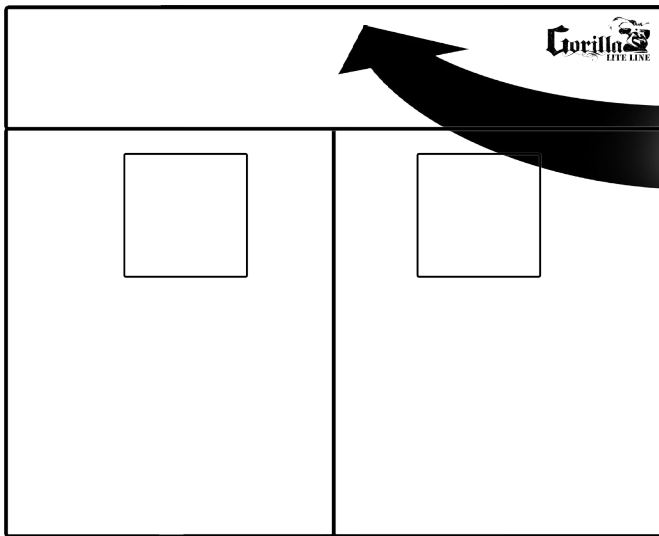

8. Place spill pool on floor of tent and secure Velcro straps around poles.

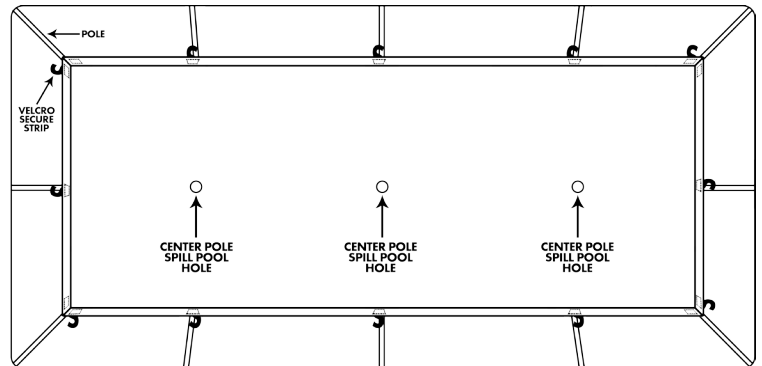
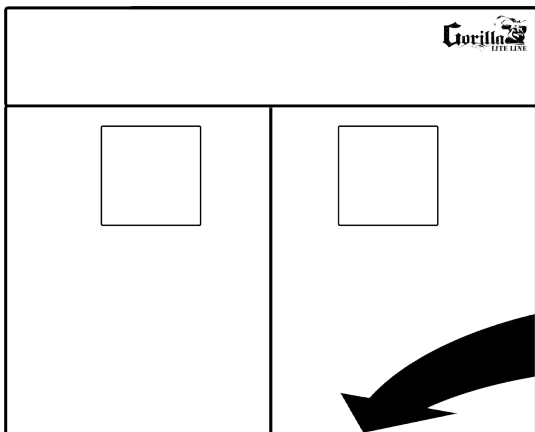

TALLEST. THICKEST. STRONGEST.

WWW.GORILLAGROWTENT.COM 1-855-G₄G₄T-G₄R₇O₆W₉